



Plastische Chirurgie  
Plastic Surgery  
Cirugía Plástica  
Chirurgia Plastica





**Reda** Instrumente GmbH  
Gänsäcker 34 - P.O. Box 131  
D-78532 Tuttlingen

Telefon +49/7462/9445-0  
Telefax +49/7462/9445-20  
e-mail: [info@Reda-Instrumente.de](mailto:info@Reda-Instrumente.de)  
<http://www.Reda-Instrumente.de>

Ausgabe Nr. 4  
Datum: 11/2016

| Charrière (Ch)<br>French (F) | Durchmesser<br>in mm | Inches |
|------------------------------|----------------------|--------|
| 1                            | 0,33                 | 0,013  |
| 2                            | 0,67                 | 0,025  |
| 3                            | 1,00                 | 0,039  |
| 4                            | 1,33                 | 0,051  |
| 5                            | 1,67                 | 0,065  |
| 6                            | 2,00                 | 0,0787 |
| 7                            | 2,33                 | 0,092  |
| 8                            | 2,67                 | 0,105  |
| 9                            | 3,00                 | 0,1181 |
| 10                           | 3,33                 | 0,131  |
| 11                           | 3,67                 | 0,144  |
| 12                           | 4,00                 | 0,1575 |
| 13                           | 4,33                 | 0,170  |
| 14                           | 4,67                 | 0,184  |
| 15                           | 5,00                 | 0,1968 |
| 16                           | 5,33                 | 0,210  |
| 17                           | 5,67                 | 0,223  |
| 18                           | 6,00                 | 0,2362 |
| 19                           | 6,33                 | 0,249  |
| 20                           | 6,67                 | 0,263  |
| 21                           | 7,00                 | 0,2756 |
| 22                           | 7,33                 | 0,288  |
| 23                           | 7,67                 | 0,302  |
| 24                           | 8,00                 | 0,3150 |
| 25                           | 8,33                 | 0,328  |
| 26                           | 8,67                 | 0,341  |
| 27                           | 9,00                 | 0,3543 |
| 28                           | 9,33                 | 0,367  |
| 29                           | 9,67                 | 0,380  |
| 30                           | 10,00                | 0,3973 |
| 31                           | 10,33                | 0,407  |
| 32                           | 10,67                | 0,420  |
| 34                           | 11,33                | 0,446  |
| 36                           | 12,00                | 0,4724 |
| 38                           | 12,67                | 0,494  |
| 40                           | 13,33                | 0,5199 |
| 45                           | 15,00                | 0,5905 |

| Gauge (G) | Durchmesser<br>in mm | Inches |
|-----------|----------------------|--------|
| 35        | 0,13                 | 0,005  |
| 34        | 0,18                 | 0,007  |
| 33        | 0,20                 | 0,008  |
| 32        | 0,23                 | 0,009  |
| 31        | 0,25                 | 0,010  |
| 30        | 0,30                 | 0,012  |
| 29        | 0,33                 | 0,013  |
| 28        | 0,36                 | 0,014  |
| 27        | 0,41                 | 0,016  |
| 26        | 0,46                 | 0,018  |
| 25        | 0,51                 | 0,020  |
|           | 0,53                 | 0,021  |
| 24        | 0,56                 | 0,022  |
| 23        | 0,64                 | 0,025  |
| 22        | 0,71                 | 0,028  |
| 21        | 0,81                 | 0,032  |
| 20        | 0,89                 | 0,035  |
|           | 0,97                 | 0,038  |
| 19        | 1,07                 | 0,042  |
| 18        | 1,27                 | 0,050  |
| 17        | 1,50                 | 0,059  |
| 16        | 1,65                 | 0,065  |
| 15        | 1,83                 | 0,072  |
| 14        | 2,11                 | 0,083  |
| 13        | 2,41                 | 0,095  |
| 12        | 2,77                 | 0,109  |
| 11        | 3,05                 | 0,120  |
| 10        | 3,40                 | 0,134  |
| 9         | 3,76                 | 0,148  |
| 8         | 4,19                 | 0,165  |
| 7         | 4,57                 | 0,180  |
| 6         | 5,16                 | 0,203  |

|       |          |
|-------|----------|
| 1 OZ  | 0,028 ml |
| 5 OZ  | 0,140 ml |
| 16 OZ | 0,450 ml |

|        |       |
|--------|-------|
| 35 OZ  | 1,0 l |
| 128 OZ | 3,7 l |

## GARANTIE / WARRANTY / GARANTIA / GARANZIA

### GARANTIE

Wir gewähren auf alle **Reda**-Instrumente 5 Jahre Garantie. Voraussetzung ist der sach- und fachgerechte Einsatz der Instrumente. Von der Garantie sind Verschleißerscheinungen ausgeschlossen.

---

### WARRANTY

Our **Reda** products are free from manufacturing defects in material and workmanship. We therefore give on all instruments a guarantee of five years provided that the instruments are maintained and cleaned properly and used normally for their intended purpose.

---

### GARANTIA

Estamos convencidos de nuestra calidad y concedemos a todos los instrumentos de **Reda** 5 años de garantía contra cualquier defecto de fabricación, siempre y cuando se usen adecuadamente. De la garantía excluimos la manifestación de desgaste.

---

### GARANZIA

Siamo convinti della nostra qualità e concediamo cinque anni di garanzia sulla funzione dei tutti gli strumenti **Reda** sotto la presupposizione che l'utilizzo è da esperto. Escluso della garanzia sono tracce di consumo.

Indikationen und Kontraindikationen finden Sie in der entsprechenden Gebrauchsanweisung!  
Indication and Contraindication please refer to our user`s manual!  
Indicaciones y Contraindicaciones se encuentran en la instrucciones de uso correspondientes!  
Indicazioni e contraindicazioni sono segnalti nel foglio istruzioni d'impiego.

---

## **Arbeitsanweisung Aufbereitung (Reinigung) und Sterilisation von resterilisierbaren chirurgischen Instrumenten**

DIN EN ISO 17664:2004 (D)

Hersteller:  
REDA Instrumente GmbH, Gänsäcker 34  
78532 Tuttlingen

Alle von Reda gelieferten wieder verwendbaren Instrumente wurden ausschließlich für den chirurgischen Gebrauch konstruiert und dürfen zu keinen anderen Zwecken benutzt werden. Unsachgemäße Handhabung und sorglose Pflege sowie zweckentfremdeter Gebrauch können zu vorzeitigem Verschleiß der Instrumente führen. Die Produkte sind bei der Auslieferung nicht sterilisiert.

### **Reinigungsvorbereitung**

Fabrikneue Instrumente müssen vor der ersten Anwendung den gesamten Aufbereitungsprozess durchlaufen. Instrumente unmittelbar nach Anlieferung aus den Folienverpackungen entnehmen und in trockenen Räumen bei gleichbleibender Raumtemperatur luftoffen lagern, um Kondensationsbildung zu vermeiden. Die Instrumente keinen Sonnenlichteinstrahlungen oder Dämpfen durch Chemikalien (Säuren oder scharfe Reinigern) aussetzen. Vor der ersten Sterilisation alle Schutzkappen und Folien vollständig entfernen und anschließend reinigen.

Gebrauchte Instrumente unmittelbar nach Beendigung des Eingriffs von Blut, Gewebe und Arzneimittel reinigen. Instrumente in eine freigegebene Lösung eines kombinierten Reinigungs- und Desinfektionsmittels, das keine proteinfixierende Wirkung besitzt, einlegen. Dosierung des Herstellers beachten. Nicht in NaCl Lösung einlegen, ansonsten Gefahr für Loch- bzw. Spannungsriss-Korrosion

Überfüllung von Instrumentensieben und Wasch-Trays vermeiden.

Gelenkinstrumente vor dem Aufbereiten öffnen. Zerlegbare Instrumente gemäß Bedienungsanleitung (Piktogramm) zur Reinigung zerlegen. Reinigungsgerechtes Zubehör verwenden. Für die manuelle Reinigung nie Metallbürsten oder Metallschwämme verwenden. Spülmaschinen und Ultraschallanlagen nicht überladen. Spül- oder Schallschatten vermeiden. Dosierung, Einwirkzeit und Einwirktemperatur bei der Desinfektion und Reinigung unbedingt einhalten. Nach der Reinigung sorgfältig spülen. Möglichst vollentsalztes (demineralisiertes) Wasser verwenden. Nach dem Spülen ausreichend trocknen. Abgenutzte, korrodierte, deformierte, poröse oder anderweitig beschädigte Instrumente austrieren.

Aus hygienischen Gründen müssen Instrumente, die zur Reparatur eingesandt werden komplett aufbereitet werden. Gelenkinstrumente nach jeder Aufbereitung mit einem Pflegemittel auf Basis von Paraffinöl behandeln (gilt nicht für flexible Endoskope und Zubehör). Funktionsprüfung in zusammengebautem Zustand durchführen. Instrumente mit Rastensperre vor der Sterilisation nur im ersten Zahn schließen.

Als Sterilisationsverfahren empfehlen wir die Dampfsterilisation (üblicherweise mit Sattedampf bei 134° C)

Sterilisation ist kein Ersatz für Sauberkeit!

Die Broschüre "Instrumenten-Aufbereitung richtig gemacht" des Arbeitskreis Instrumenten-Aufbereitung dient als Anhalt.

Reda Instrumente GmbH  
78532 Tuttlingen

## IMPORTANT INFORMATION CONCERNING PREPARING AND STERILIZING SURGICAL INSTRUMENTS

Dear Sirs,  
please read the following instructions very carefully before using the instruments.

### 1. INITIAL USE

All instruments which are being used for the first time must be thoroughly cleaned, rinsed and then sterilized before using.

### 2. TREATING INSTRUMENTS AFTER USAGE

a.) The instruments might be immediately thoroughly cleaned and disinfected. Please follow the manufacturer's instructions when using cleaning agents and disinfectants.

b.) Instruments which may be dismantled must be cleaned and disinfected after being taken apart.

c.) Cleaning may be carried out either manually or with a machine. Care should be taken that only cleaning agents and disinfectants are used, which are changed daily.

d.) Following chemical disinfection and manual cleaning, all instruments must always be thoroughly rinsed under running water.

e.) The temperature of water used in a machine for cleaning should not exceed 45°C.

f.) Whether cleaning is carried out manually or by machine, we especially ask you to ensure that the correct dosage for cleaning solutions or the correct combination of disinfectant and cleaning solution, is employed. Similar importance should be applied to the length of time the agents require to perform properly and to the temperature set.

g.) Hinged instruments should be opened before cleaning.

h.) Please ensure that the perforated instrument trays, when loaded, do not exceed 10 kg in weight.

i.) Please take care that when instruments are being cleaned they are arranged proper in a manne that fluids can circulate freely.

j.) Deposits remaining after the cleaning process must be completely removed in the first rinse which now follows. The optimum temperature for final rinsing has proved to be between 70° and 90° C. Please use only purified water in this final cleaning stage.

k.) The instruments must be carefully dried after cleaning and rinsing is completed.

l.) Moving parts and the cutting edges of shears and scissors must be treated with preservatives which are both suitable and physiologically safe.

### 3. TESTING FOR CORRECT FUNCTIONING

a.) Instruments must be carefully and thoroughly checked before every occasion that they are used.

b.) After each time they are cleaned, the instruments must be macroscopically clean, i.e., visibly free from proteinbased residues and other soiling.

c.) Care should be taken so that cracks, breakages and corrosion are noticed.

d.) Instruments with flecks should be separated and taken out for special treatment.

e.) All moving parts as well as working tips and blades should be checked with special care.

f.) Checking should be carried out according to the extent to which the instruments will be used.

g.) Instruments which are in any way defective or damaged should be immediately sorted out from the others.

### 4. STERILIZATION

a.) All stainless steel surgical instruments supplied by us may be sterilized in an autoclave.

b.) Please follow the manufacturer's operating instructions when using autoclave. All machines used must comply with all current quality and other standards.

c.) Instruments are being sterilized/ autoclaved at a temperature of 134°C.

d.) Sterilization packing material must comply with all current standards.

e.) Instruments with ratchets or self-retaining mechanisms should be sterilized opened or in the first ratchet position.

f.) Please ensure that perforated instrument trays, when loaded do not exceed 10 kg in weight.

### 5. IN GENERAL

a.) All surgical instruments supplied by us have been thoroughly inspected before dispatch and leave our factory in perfect condition. Damage which can arise as a result of transporting, cleaning, preserving, sterilizing or storing, must be prevented.

b.) Please handle surgical instruments always with the utmost care.

c.) Instruments must be stored in a clean and dry place.

d.) If you have any queries or problems please contact us at any time:

We should like to point out that, if the above-mentioned directions are not followed or the instruments supplied by us are not properly used, all guarantee claims become void and any consequences must be borne by yourselves.

## SUGERENCIAS PARA LA LIMPIEZA, ESTERILIZACIÓN Y MANTENIMIENTO DE INSTRUMENTOS QUIRÚRGICOS

### ENJUAGADO

Tras el uso enjuagar enseguida los instrumentos bajo un chorro de agua caliente (no hirviendo). El enjuagado debe servir para quitar los residuos de sangre, mucosas y tejidos.

### LIMPIEZA

Si la limpieza no se efectúa inmediatamente después del enjuagado, los instrumentos tienen que sumergirse en una solución de agua y detergente con PH neutro (7)

Para los instrumentos muy delicados (algunos tipos de porta agujas o tijeras se aconseja una limpieza manual: ver punto "C").

#### a.- Limpieza en la pila de ultrasonido

Los instrumentos tienen que estar en la pila el tiempo necesario recomendado por el fabricante para efectuar el ciclo del lavado, generalmente de 5 a 10 minutos.

Los instrumentos con bisagras o juntas (articulaciones) tienen que sumergirse en la pileta en posición abierta.

Asegurarse de que las hojas afiladas de las tijeras, bisturís para gingivectomía, curetas, etc. no estén en contacto con otros instrumentos.

Todos los instrumentos deben estar completamente sumergidos en la solución de lavado.

No poner instrumentos de diferentes metales (acero inoxidable, instrumentos cromados, latón, etc.) en el mismo ciclo de lavado.

Cambiar a menudo la solución para el lavado, como mínimo todas las veces que lo recomienda el fabricante de la pila de ultrasonidos.

Enjuagar concienzudamente los instrumentos con agua corriente tras lavado con ultrasonidos para quitar los residuos de la solución de lavado.

#### b.- Limpieza con lavadora

Seguir las indicaciones del fabricante. Asegurarse de que los instrumentos hayan sido lubricados tras el último ciclo de lavado y antes del ciclo de esterilización.

#### c.- Limpieza manual

La mayor parte de los fabricantes de instrumentos indican el lavado con los ultrasonidos como el modo mejor y más eficaz para limpiar los instrumentos quirúrgicos, especialmente los que tienen bisagras, cierres y en general articulaciones. Si la limpieza con los ultrasonidos no es posible, se aconseja usar el método siguiente:

- Usar cepillos rígidos de plástico, nylon, etc.
- Cepillar concienzudamente los instrumentos más delicados y, si es posible, enjuagar, limpiar y esterilizar estos instrumentos separadamente.
- Verificar que toda la superficie de estos instrumentos esté limpia.
- Tras haber cepillado los instrumentos, enjuagarlos bajo el chorro de agua corriente.
- Durante el enjuagado abrir y cerrar las tijeras, las pinzas hemostáticas, los porta agujas y los demás instrumentos con bisagras o juntas y asegurarse de que las partes internas de las bisagras estén perfectamente enjuagadas como la superficie externa del instrumento.

### SECADO, LUBRIFICACIÓN E INSPECCIÓN

Tras las operaciones de limpieza y de enjuagado, los instrumentos quirúrgicos tienen que ser secados perfectamente.

Todos los instrumentos con juntas o bisagras (acción "metal contra metal") como tijeras, pinzas hemostáticas, porta agujas, fórceps de extracción, etc., tienen que ser lubricados. Se aconsejan lubricantes específicos para el instrumental quirúrgico. No usar aceites o lubricantes industriales.

A este punto es buena norma inspeccionar el estado de cada instrumento y verificar el funcionamiento según el uso específico. Controlar y asegurarse de que:

- Las hojas de las tijeras estén lisas de arriba abajo y de que, una vez cerradas, no hagan juego. Probar las tijeras cortando gasa muy fina. Tres cuartas parte de la hoja tienen que cortar la gasa sin retenerla.

- Las puntas de las pinzas estén al mismo nivel.
- Las pinzas hemostáticas y los porta agujas no dejen pasar la luz entre las puntas cuando estén cerradas, se abran y cierren fácilmente y que las bisagras no estén demasiado flojas.
- Controlar el desgaste de la porta agujas sobre la superficie interna de las puntas.
- Las cánulas metálicas de aspiración estén bien limpias en su interior.
- Los instrumentos cortantes y los bisturís tengan las hojas bien afiladas y no estropeadas.

### ESTERILIZACIÓN EN AUTOCLAVE

Tras haber enjuagado, limpiado, secado, lubricado e inspeccionado los instrumentos, éstos pueden ser preparados para la esterilización separadamente o en serie.

Instrumentos individuales:

Las bolsas especiales monouso son el ideal para contener los instrumentos. Asegurarse de que las bolsas que contendrán los instrumentos con cierres y articulaciones (pinzas hemostáticas, porta agujas, etc.) sean lo bastante grandes como para contener los citados instrumentos en posición abierta.

Instrumentos en serie:

Poner los instrumentos en los especiales cestos o bandejas de acero inoxidable. Poner los instrumentos más pesados en la parte inferior cuando sean necesarias varias bandejas.

No cerrar nunca los instrumentos durante el ciclo en autoclave. Un instrumento cerrado no estará nunca bien esterilizado, ya que el vapor no puede penetrar en la parte de cierre a contacto "metal contra metal". En el instrumento podría además romperse en la parte de la bisagra a causa de la expansión del metal debida al calor durante el ciclo del autoclave.

No cargar demasiado la cámara del autoclave ya que algunos instrumentos podrían formar "zonas de sombra" sobre otros en los que el vapor no penetraría.

### ATENCIÓN

Al final del ciclo de esterilización - antes del ciclo de secado- abrir ligeramente la portezuela del autoclave y proceder con el ciclo desecado según las instrucciones del fabricante. Si la portezuela del autoclave se abriese completamente antes del ciclo de secado, el aire frío de la habitación entraría en la cámara del autoclave causando la formación de condensación sobre los instrumentos y de consecuencia aparecerían las manchas de agua que vemos a menudo en los mismos.

### ESTERILIZACIÓN EN FRÍO:

La mayor parte de las soluciones para la esterilización en frío esterilizan los instrumentos completamente tras 10 horas de inmersión. Esta acción química prolongada puede ser más perjudicial para los instrumentos que el ciclo normal de 20 minutos en autoclave.

Si los instrumentos tienen necesidad de ser simplemente "desinfectados", el proceso en frío es adecuado, ya que la desinfección tiene lugar en 10 minutos solamente.

Recuerde bien la diferencia entre:

**ESTÉRIL** - término absoluto (ningún organismo logra sobrevivir) y

**DESINFECTADO** - perfectamente limpio.

Usen siempre la técnica más adecuada de esterilización/limpieza de los instrumentos según el uso que se haga posteriormente de ellos.

Recuerden que la esterilización de los instrumentos no sustituye la limpieza de los mismos.

Recomendamos no volver a usar ni esterilizar los artículos de un solo uso.

Si se tratan en el modo correcto los instrumentos contruidos con las modernas aleaciones inoxidables pueden durar muchos años.



## INDICAZIONI PER LA CURA, PULITURA E LA STERILIZZAZIONE DELLO STRUMENTARIO CHIRURGICO RISTERILIZZABILE

### Misure preventive anticorrosione

- 1) Raggruppare accuratamente gli strumenti correttamente confezionati e sterilizzati prima dell'operazione; selezionarli secondo l'intervento. Verificare sempre che la confezione esterna sia integra e che lo strumento stesso non sia danneggiato.
- 2) Assicurarli tramite l'indicatore di sterilizzazione collocato all'interno del vaglio che il contenuto sia stato sterilizzato.
- 3) Disporre gli strumenti seguendo l'ordine di utilizzo durante l'operazione; lasciare gli strumenti non necessari nel vaglio; predisporre gli strumenti solo immediatamente prima dell'operazione.
- 4) Nel corso dell'operazione rimuovere dagli strumenti sangue ed altri materiali biologici; dopo l'uso, riporre gli strumenti nel corretto alloggiamento.
- 5) Risciacquare opportunamente gli strumenti cavi, al fine di evitare l'adesione di sangue e polvere d'osso.
- 6) Per la pulitura degli strumenti utilizzare una soluzione lattata o una soluzione salina, ma non immergerli nelle suddette soluzioni.
- 7) Iniziare l'operazione di pulitura subito dopo l'intervento. Strumenti utilizzati su pazienti con possibili infezioni: smaltire in modo analogo, eliminando sangue, polvere d'osso parti di tessuto in eccesso.
- 8) Pulire gli strumenti in un luogo previsto nell'ambito della sala operatoria.

Nel caso in cui gli strumenti vadano collocati direttamente nella centrale di sterilizzazione, è necessario dapprima coprirli, per evitare il rischio di contaminazione ai danni del personale o dell'ambiente circostante.

### Disinfezione

Durante l'uso di disinfettanti chimici è necessario osservare scrupolosamente le indicazioni del produttore; utilizzare le soluzioni sempre previa diluizione. Nella fase termica di disinfezione con acqua bollente assicurarsi che l'acqua sia priva di corpi estranei.

### Pulitura

Indipendentemente dal metodo utilizzato per la pulitura (meccanico o manuale) si raccomanda di verificare attentamente quale detergente vada utilizzato con ciascun metodo. Valori pH consigliati: tra 7,0 e 8,5.

#### 1) Pulitura meccanica

Osservare scrupolosamente le istruzioni d'uso fornite dal produttore della macchina pulitrice. Predisporre gli

strumenti per la pulitura meccanica. Tutti gli strumenti appuntiti e delicati dovrebbero essere puliti manualmente.

Non sovraccaricare i vagli, mettere gli strumenti pesanti sul fondo del vaglio. Se necessario, immergere e risciacquare gli strumenti molto sporchi (strumenti cavi), prima di collocarli nella lavatrice.

#### 2) Pulitura ad ultrasuoni

##### (fa parte dei metodi di pulitura meccanica)

Prima di inserire uno strumento nel bagno ad ultrasuoni, rimuovere i materiali organici in eccesso. I bagni ad ultrasuoni sono consigliati per le filettatrici o gli strumenti con solchi profondi. L'ultrasuono deve essere seguito da un programma di risciacquo normale.

#### 3) Pulitura manuale

Richiede diverse spazzole in nylon, una canna da soffio ed un ugello da soffio/ un dispositivo ad aria compressa pulito, detergenti e solventi come per la pulitura meccanica.

Per gli additivi di pulitura osservare le indicazioni fornite dal produttore.

Per la pulitura degli strumenti dotati di cannula, passare più volte lo spazzolino di nylon attraverso la cannula eseguendo movimenti rotatori (non utilizzare spazzole in lana d'acciaio/metallo) fino alla completa rimozione dei residui eliminabili con questo metodo.

Soffiare poi con aria compressa nella cannula.

#### 4) Asciugatura

Ogni strumento deve essere asciugato completamente sia internamente che esternamente per evitare la formazione di ruggine o malfunzionamenti.

#### Indicazioni per la sterilizzazione della strumentazione

Pulire immediatamente ed asciugare bene gli strumenti usati, non utilizzare detergenti e disinfettanti con additivi fortemente acidi o alcalini (ad es. soda, soda caustica o acidi)!

#### Sterilizzare la strumentazione solo a vapore A 134°!

Prima della sterilizzazione, assicurarsi che gli strumenti siano perfettamente funzionanti ed integri. La sterilizzazione non sostituisce la pulitura.

Markierungs- und Messinstrumente  
Marking and Measuring Instruments  
Instrumentos para marcar y medir  
Strumenti per marcare e misurare



Winkelmesser  
Goniometer  
Goniómetro  
Goniometro

MOELTGEN  
03312-01  
24 cm, 9<sup>1</sup>/<sub>2</sub>"

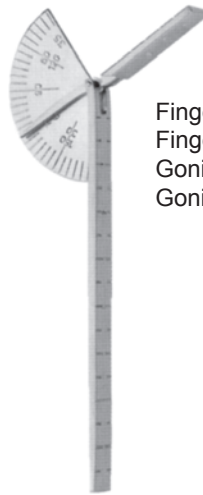

Finger-Goniometer  
Finger goniometer  
Goniómetro para dedos  
Goniometro per le dita

03314-01  
13 cm, 5<sup>1</sup>/<sub>8</sub>"



|          |       |                                  |
|----------|-------|----------------------------------|
| 03340-10 | 10 cm | 4"                               |
| 03340-15 | 15 cm | 6"                               |
| 03340-20 | 20 cm | 8"                               |
| 03340-30 | 30 cm | 11 <sup>3</sup> / <sub>4</sub> " |
| 03340-50 | 50 cm | 19 <sup>3</sup> / <sub>4</sub> " |

Markierungsinstrumente  
 Marking Instruments  
 Instrumentos para marcar  
 Strumenti per marcare

3 x 3



Facelift-Markierer  
 Facelift marker  
 Marcador para facelift  
 Marcatore per facelift

03385-16 16 cm, 6<sup>1</sup>/<sub>4</sub>"  
 03385-26 26 cm, 10"

2 x 2



Facelift-Markierer  
 Facelift marker  
 Marcador para facelift  
 Marcatore per facelift



PITANGUY  
 03370-16  
 16 cm, 6<sup>1</sup>/<sub>4</sub>"

D'ASSUMPCAO  
 03380-30  
 30 cm, 12"

2 x 2



LOCKWOOD  
 03390-30  
 32,5 cm, 12<sup>3</sup>/<sub>4</sub>"

Markierungs- und Messinstrumente  
 Marking and Measuring Instruments  
 Instrumentos para marcar y medir  
 Strumenti per marcare e misurare



FREEMAN

- 03500-34 Ø 34 mm, 1<sup>3</sup>/<sub>8</sub>"
- 03500-36 Ø 36 mm, 1<sup>5</sup>/<sub>8</sub>"
- 03500-38 Ø 38 mm, 1<sup>1</sup>/<sub>2</sub>"
- 03500-42 Ø 42 mm, 1<sup>2</sup>/<sub>3</sub>"
- 03500-45 Ø 45 mm, 1<sup>3</sup>/<sub>4</sub>"
- 03500-50 Ø 50 mm, 2"



FREEMAN

- 03520-34 Ø 34 / 36 mm
- 03520-38 Ø 38 / 42 mm
- 03520-45 Ø 45 / 50 mm



GROSSMAN

- 03505-00
- Ø 40, 44, 48, 52

ALUMINIUM



FREEMAN

- 03501-34 Ø 34 / 36 mm
- 03501-38 Ø 38 / 42 mm
- 03501-45 Ø 45 / 50 mm



FREEMAN

- 03530-34 Ø 34 mm, 1<sup>3</sup>/<sub>8</sub>"
- 03530-36 Ø 36 mm, 1<sup>5</sup>/<sub>8</sub>"
- 03530-38 Ø 38 mm, 1<sup>1</sup>/<sub>2</sub>"
- 03530-42 Ø 42 mm, 1<sup>2</sup>/<sub>3</sub>"
- 03530-45 Ø 45 mm, 1<sup>3</sup>/<sub>4</sub>"
- 03530-50 Ø 50 mm, 2"



- 03540-32 Ø 32 mm, 1<sup>1</sup>/<sub>4</sub>"
- 03540-37 Ø 37 mm, 1<sup>1</sup>/<sub>2</sub>"
- 03540-43 Ø 43 mm, 1<sup>3</sup>/<sub>4</sub>"

Markierungs- und Messinstrumente  
Marking and Measuring Instruments  
Instrumentos para marcar y medir  
Strumenti per marcare e misurare



McKISSOCK  
14 cm, 5 1/2"

- 03400-38 38 mm, 1 1/2"
- 03400-42 42 mm, 1 2/3"
- 03400-45 45 mm, 1 3/4"

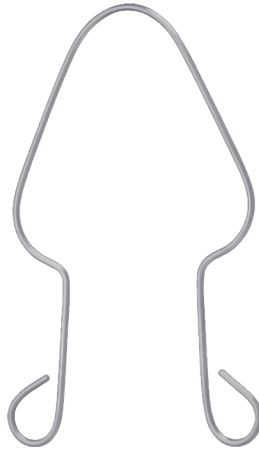

ACKERMANN  
10 cm, 4"

- 03550-14 140 mm, 5 1/2"
- 03550-16 160 mm, 6 1/4"



HALPREN

- 03560-34 34 mm, 1 1/2"
- 03560-38 38 mm, 1 2/3"
- 03560-42 42 mm, 1 3/4"



CASTROVIEJO

- 43583-07 9 cm, 3 1/2"
- 43583-18 18 cm, 7"

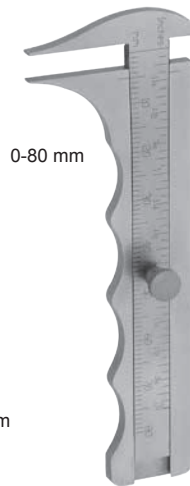

0-80 mm

JAMESON

- 43585-00  
9,5 cm, 3 3/4"



COLLIER

- 73193-30  
30 cm, 11 3/4"

Dermatome  
Dermatome  
Dermàtomo  
Dermatomo



SCHINK  
07490-00  
30 cm, 11<sup>3</sup>/<sub>4</sub>"

compl.  
mit/with/con  
07490-01 (1) Stk./pcs  
07490-02 (2) Stk./pcs



07490-01

Ersatzklinge  
Spare blade  
Hoja de repuesto  
Lama di ricambio per dermatomo

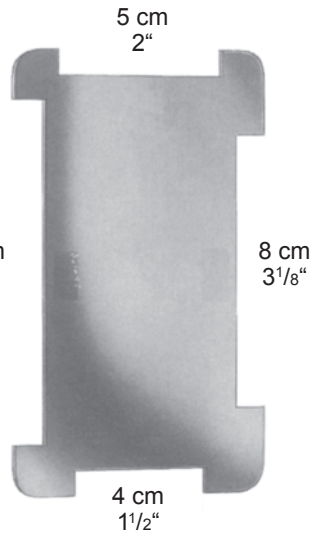

07490-02

Spannplatte  
Skin straightening plate  
Placa para extender la piel  
Placca per stendipelle

Dermatome  
Dermatome  
Dermátomo  
Dermatomo



HUMBY  
07495-31  
31 cm, 12<sup>1</sup>/<sub>4</sub>"



SILVER  
07498-00  
19 cm, 7<sup>1</sup>/<sub>2</sub>"



WATSON  
07499-00  
30 cm, 11<sup>3</sup>/<sub>4</sub>"

---

Ersatzklingen, unsteril / Spare blade, non sterile  
Hoja de repuesto, no esteril / Lama di ricambio, non sterile

07496-31

07296-00

07499-01

Skalpelligriffe  
Scalpel Handles  
Mangos de bisturios  
Manici per lama bisturi

passend zu den Klängen  
for blades  
para las hojas  
per lama bisturi

(A) No. 10, 11, 12, 13, 14, 15, 16, 17, 18, 19



07103-00  
Fig. 3

(A)



07103-01  
Fig. 3 grad

(A)



07103-02  
Fig. 3 L

(A)



07109-03  
Fig. 3 L

(A)



Skalpellgriffe  
 Scalpel Handles  
 Mangos de bisturíes  
 Manici per lama bisturi

passend zu den Klängen  
 for blades  
 para las hojas  
 per lama bisturi

(A) No. 10, 11, 12, 13, 14, 15, 16, 17, 18, 19

(B) No. 20, 21, 22, 23, 24, 25



07104-00  
 Fig. 4

(B)



07104-02  
 Fig. 4 L

(B)



07105-02  
 Fig. 4 L

(B)



07106-01  
 Fig. 3

(A)

Skalpellgriffe  
Scalpel Handles  
Mangos de bisturios  
Manici per lama bisturi

passend zu den Klängen  
for blades  
para las hojas  
per lama bisturi

- (A) No. 10, 11, 12, 13, 14, 15, 16, 17, 18, 19
- (B) No. 20, 21, 22, 23, 24, 25



07107-00  
Fig. 7

(A)



07107-01  
Fig. 7K

(A)



07108-00  
Fig. 8

(B)

Mini-Skalpellgriffe/Skalpellklingen  
Scalpel Handles  
Mangos de bisturías  
Manici per lama bisturi/lame per bisturi



07161-00 07162-00 07165-00 07167-00

Packung mit 10 Stück  
box of 10  
en cajas de 10 unidades  
confezione di 10 pezzi

07109-10 10,0 cm, 4"  
07109-13 13,0 cm, 5<sup>1</sup>/<sub>8</sub>"  
07109-15 15,5 cm, 6"

Skalpelli  
Scalpel Handles  
Mangos de bisturios  
Manici per lama bisturi

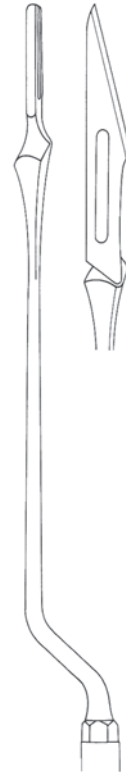

LANDOLT  
93385-21 21 cm, 8<sup>1</sup>/<sub>4</sub>"  
93385-25 25 cm, 10"

93390-21 21 cm, 8<sup>1</sup>/<sub>4</sub>"

Präparierscheren  
Dissecting Scissors  
Tijeras de disección  
Forbici per dissezione



MAYO



|                    |   |                    |
|--------------------|---|--------------------|
| 09160-14           | 14 cm, 5 <sup>1</sup> / <sub>2</sub> "    | 09161-14           |
| <b>09164-14 TC</b> | <b>14 cm, 5<sup>1</sup>/<sub>2</sub>"</b> | <b>09165-14 TC</b> |
| <b>09962-14 SC</b> | <b>14 cm, 5<sup>1</sup>/<sub>2</sub>"</b> | <b>09963-14 SC</b> |
| 09160-17           | 17 cm, 6 <sup>3</sup> / <sub>4</sub> "    | 09161-17           |
| <b>09164-17 TC</b> | <b>17 cm, 6<sup>3</sup>/<sub>4</sub>"</b> | <b>09165-17 TC</b> |
| <b>09962-17 SC</b> | <b>17 cm, 6<sup>3</sup>/<sub>4</sub>"</b> | <b>09963-17 SC</b> |

Präparierscheren  
 Dissecting Scissors  
 Tijeras de disección  
 Forbici per dissezione



MAYO-STILLE



09170-15

15 cm, 6"

**09174-15 TC**

15 cm, 6"

**09964-15 SC**

15 cm, 6"



09171-15

**09175-15 TC**

**09965-15 SC**



09170-17

17 cm, 6<sup>3</sup>/<sub>4</sub>"

**09174-17 TC**

17 cm, 6<sup>3</sup>/<sub>4</sub>"

**09964-17 SC**

17 cm, 6<sup>3</sup>/<sub>4</sub>"

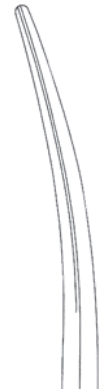

09171-17

**09175-17 TC**

**09965-17 SC**

Präparierscheren  
Dissecting Scissors  
Tijeras de disección  
Forbici per dissezione



LEXER

|             |  |             |
|-------------|--|-------------|
|             |  |             |
| 09190-16    | 16 cm, 6 <sup>1</sup> / <sub>4</sub> " | 09191-16    |
| 09194-16 TC | 16 cm, 6 <sup>1</sup> / <sub>4</sub> " | 09195-16 TC |



LEXER-BABY

|             |           |             |
|-------------|-----------|-------------|
|             |           |             |
| 09202-10    | 10 cm, 4" | 09203-10    |
| 09206-10 TC | 10 cm, 4" | 09207-10 TC |

Präparierscheren  
Dissecting Scissors  
Tijeras de disección  
Forbici per dissezione



METZENBAUM



|                    |   |                    |
|--------------------|---|--------------------|
| 09280-12           | 12 cm, 4 <sup>3</sup> / <sub>4</sub> "    | 09281-12           |
| <b>09284-12 TC</b> | <b>12 cm, 4<sup>3</sup>/<sub>4</sub>"</b> | <b>09285-12 TC</b> |
| <b>09966-11 SC</b> | <b>12 cm, 4<sup>3</sup>/<sub>4</sub>"</b> | <b>09967-11 SC</b> |
| 09280-15           | 15 cm, 6"                                 | 09281-15           |
| <b>09284-15 TC</b> | <b>15 cm, 6"</b>                          | <b>09285-15 TC</b> |
| <b>09970-14 SC</b> | <b>15 cm, 6"</b>                          | <b>09971-14 SC</b> |
| 09280-18           | 18 cm, 7"                                 | 09281-18           |
| <b>09284-18 TC</b> | <b>18 cm, 7"</b>                          | <b>09285-18 TC</b> |
| <b>09970-18 SC</b> | <b>18 cm, 7"</b>                          | <b>09971-18 SC</b> |
| 09280-20           | 20 cm, 8"                                 | 09281-20           |
| <b>09284-20 TC</b> | <b>20 cm, 8"</b>                          | <b>09285-20 TC</b> |
| <b>09970-20 SC</b> | <b>20 cm, 8"</b>                          | <b>09971-20 SC</b> |
| 09280-23           | 23 cm, 9"                                 | 09281-23           |
| <b>09284-23 TC</b> | <b>23 cm, 9"</b>                          | <b>09285-23 TC</b> |
| <b>09970-23 SC</b> | <b>23 cm, 9"</b>                          | <b>09971-23 SC</b> |



Präparierscheren  
Dissecting Scissors  
Tijeras de disección  
Forbici per dissezione



METZENBAUM



09270-15  
09270-18

15 cm, 6"  
18 cm, 7"

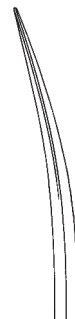

09271-15  
09271-18

|             |           |             |
|-------------|-----------|-------------|
| 09274-15 TC | 15 cm, 6" | 09275-15 TC |
| 09274-18 TC | 18 cm, 7" | 09275-18 TC |



METZENBAUM-FINO



09282-15  
09286-15 TC

15 cm, 6"  
15 cm, 6"



09283-15  
09287-15 TC

|             |           |             |
|-------------|-----------|-------------|
| 09282-18    | 18 cm, 7" | 09283-18    |
| 09286-18 TC | 18 cm, 7" | 09287-18 TC |

|             |           |             |
|-------------|-----------|-------------|
| 09282-20    | 20 cm, 8" | 09283-20    |
| 09286-20 TC | 20 cm, 8" | 09287-20 TC |

|             |           |             |
|-------------|-----------|-------------|
| 09282-23    | 23 cm, 9" | 09283-23    |
| 09286-23 TC | 23 cm, 9" | 09287-23 TC |

Präparierscheren  
Dissecting Scissors  
Tijeras de disección  
Forbici per dissezione



SANVENERO



09302-14

14 cm, 5 1/2"



09303-14



JOSEPH



09304-14

14 cm, 5 1/2"



09305-14

Präparierscheren  
Dissecting Scissors  
Tijeras de disección  
Forbici per dissezione



- |                    |   |
|--------------------|---|
| 09310-12           | 12 cm, 4 <sup>3</sup> / <sub>4</sub> "    |
| <b>09314-12 TC</b> | <b>12 cm, 4<sup>3</sup>/<sub>4</sub>"</b> |
| <b>09995-12 SC</b> | <b>12 cm, 4<sup>3</sup>/<sub>4</sub>"</b> |
| 09310-15           | 15 cm, 6"                                 |

KILNER (RAGNELL)



- REYNOLDS (JAMESON)
- |                    |                  |
|--------------------|------------------|
| 09321-15           | 15 cm, 6"        |
| <b>09993-15 SC</b> | <b>15 cm, 6"</b> |
| 09321-18           | 18 cm, 7"        |

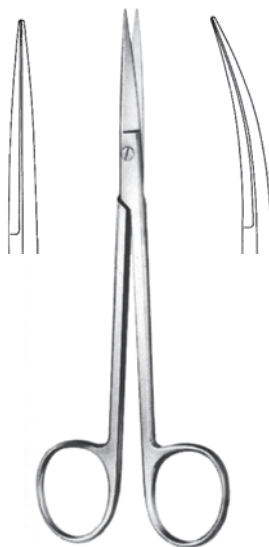

- KELLY
- |                    |   |                    |
|--------------------|---|--------------------|
| 09540-16           | 16 cm, 6 <sup>1</sup> / <sub>4</sub> "    | 09541-16           |
| <b>09542-16 TC</b> | <b>16 cm, 6<sup>1</sup>/<sub>4</sub>"</b> | <b>09543-16 TC</b> |
| <b>09544-16 SC</b> | <b>16 cm, 6<sup>1</sup>/<sub>4</sub>"</b> | <b>09545-16 SC</b> |

Feine Scheren  
 Delicate Scissors  
 Tijeras finas  
 Forbici delicate



IRIS

|                    |                      |                    |
|--------------------|----------------------|--------------------|
| 09340-09           | 9 cm, 3 1/2"         | 09341-09           |
| 09340-10           | 10 cm, 4"            | 09341-10           |
| 09340-11           | 11 cm, 4 3/8"        | 09341-11           |
| <b>09344-11 TC</b> | <b>11 cm, 4 3/8"</b> | <b>09345-11 TC</b> |
| <b>09980-11 SC</b> | <b>11 cm, 4 3/8"</b> | <b>09981-11 SC</b> |



BONN

09342-08 8 cm, 3 1/8" 09343-08

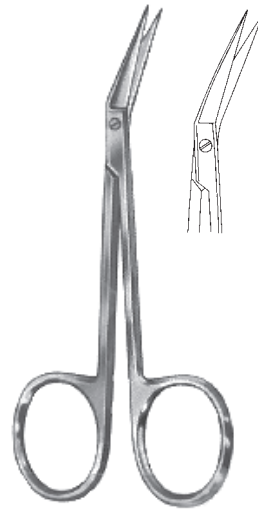

IRIS

09346-11  
 11 cm, 4 3/8"

Feine Scheren  
Delicate Scissors  
Tijeras finas  
Forbici delicate



KNAPP  
10 cm, 4"



09348-01



09348-02



09348-03



09348-04



09348-05



09348-06

Feine Scheren  
Delicate Scissors  
Tijeras finas  
Forbici delicate



LITTLER  
09349-12  
12 cm, 4<sup>3</sup>/<sub>4</sub>"



GRAEFE  
09350-10  
10 cm, 4"

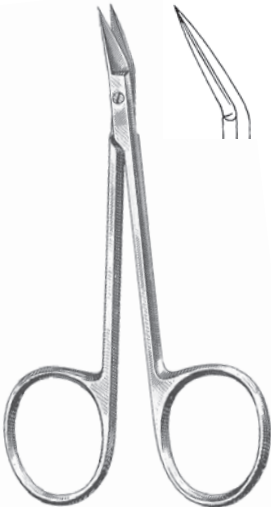

CONVERSE/WILMER/WALTER  
09352-10  
10 cm, 4"



COTTLE  
09358-11  
11 cm, 4<sup>3</sup>/<sub>8</sub>"

Feine Scheren  
Delicate Scissors  
Tijeras finas  
Forbici delicate



GRADLE  
09350-09 9,5 cm, 3<sup>3</sup>/<sub>4</sub>" 09351-09



09352-09 9,5 cm, 3<sup>3</sup>/<sub>4</sub>" 09353-09



09354-10 10 cm, 4" 09355-10



09356-10 10 cm, 4" 09357-10

Feine Scheren  
 Delicate Scissors  
 Tijeras finas  
 Forbici delicate



STEVENS  
 11 cm, 4<sup>3</sup>/<sub>8</sub>"

spitz  
 sharp  
 agudo  
 acuti



09360-11  
**09984-11SC**



09361-11  
**09985-11 SC**

stumpf  
 blunt  
 romo  
 smussi



09362-11



09363-11

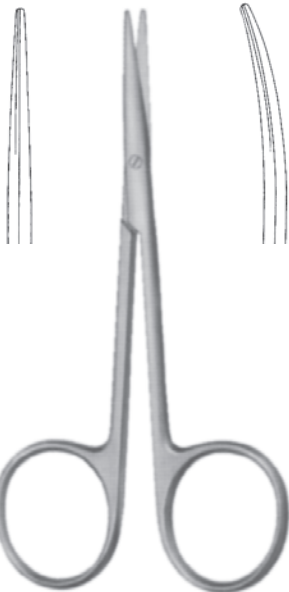

STRABISMUS

09370-11 11 cm, 4<sup>3</sup>/<sub>8</sub>" 09371-11

09374-11TC 11 cm, 4<sup>3</sup>/<sub>8</sub>" 09375-11TC



Feine Scheren  
Delicate Scissors  
Tijeras finas  
Forbici delicate



WAGNER  
12 cm, 4<sup>3</sup>/<sub>4</sub>"



09828-12



09826-12



09824-12  
**09982-12SC**



WAGNER  
12 cm, 4<sup>3</sup>/<sub>4</sub>"



09823-12



09829-12



09825-12  
**09983-12 SC**

Zahnfleischscheren  
Gum Scissors  
Tijeras para encias  
Forbici gengivali

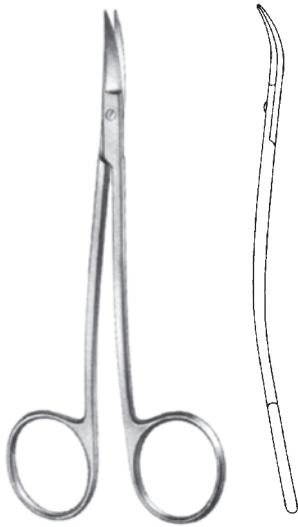

LA GRANGE  
09854-11  
11,5 cm, 4 1/2"



CHADWICK  
09855-11  
11,5 cm, 4 1/2"

Nasenscheren  
Nasal Scissors  
Tijeras nasales  
Forbici nasali



HEYMAN  
09401-18 18 cm, 7"



FOMON  
09403-15 15 cm, 6"



COTTLE  
09405-16 16 cm, 6<sup>1</sup>/<sub>4</sub>"  
09405-16TC 16 cm, 6<sup>1</sup>/<sub>4</sub>"

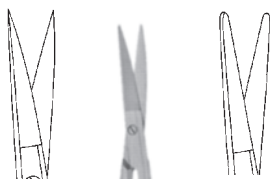

COTTLE-MASING  
09406-10 10 cm, 4" 09407-10



FOMON  
09617-13 13 cm, 5<sup>1</sup>/<sub>8</sub>"

Fadenscheren  
Stitch Scissors  
Tijeras para hilos  
Forbici taglia fili



SPENCER  
09802-09 9 cm, 3<sup>1</sup>/<sub>2</sub>"  
09802-11 11 cm, 4<sup>3</sup>/<sub>8</sub>"



LITTAUER  
09804-14  
14 cm, 5<sup>1</sup>/<sub>2</sub>"



O'BRIEN  
09805-09  
9 cm, 3<sup>1</sup>/<sub>2</sub>"

Knorpelscheren/Zahnfleischscheren  
Cartilage Scissors/Gum Scissors  
Tijeras para cartilago/Tijeras para encías  
Forbici per cartilagine/Forbici gengivali



MC INDOE  
09614-19  
19 cm, 7<sup>1</sup>/<sub>2</sub>"

1 Schneide gezahnt  
1 blade toothed  
1 hoja dentada  
1 taglio dentellato



09820-13

GOLDMAN-FOX  
13 cm, 5<sup>1</sup>/<sub>8</sub>"

09821-13  
**09821-13SC**

Face-Lift Scheren  
 Face-Lift Scissors  
 Face Lift tijeras  
 Face Lift forbici

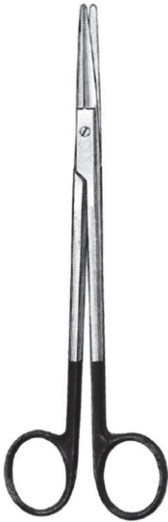

GORNEY



10010-19

19 cm, 7 $\frac{1}{2}$ "



10011-19

10012-19 TC

19 cm, 7 $\frac{1}{2}$ "

10013-19 TC

10014-19 SC

19 cm, 7 $\frac{1}{2}$ "

10015-19 SC



GORNEY-FREEMAN

10061-19

19 cm, 7 $\frac{1}{2}$ "

10061-19 TC

19 cm, 7 $\frac{1}{2}$ "

10061-19 SC

19 cm, 7 $\frac{1}{2}$ "

10061-23

23 cm, 9"

10061-23 TC

23 cm, 9"

10061-23 SC

23 cm, 9"

Face-Lift Scheren  
 Face-Lift Scissors  
 Face-Lift tijeras  
 Face Lift forbici



KAYE

|             |               |             |
|-------------|---------------|-------------|
| 10028-14 TC | 14 cm, 5 1/2" | 10029-14 TC |
| 10034-14 SC | 14 cm, 5 1/2" | 10035-14 SC |
| 10030-18 TC | 18 cm, 7"     | 10031-18 TC |
| 10036-18 SC | 18 cm, 7"     | 10037-18 SC |
| 10032-23 TC | 23 cm, 9"     | 10033-23 TC |
| 10038-23 SC | 23 cm, 9"     | 10039-23 SC |



PECK-JOSEPH

|             |                 |             |
|-------------|-----------------|-------------|
| 10044-14    | 14,5 cm, 5 3/4" | 10045-14    |
| 10048-14 SC | 14,5 cm, 5 3/4" | 10049-14 SC |



BEUSE

|          |               |          |
|----------|---------------|----------|
| 10050-14 | 14 cm, 5 1/2" | 10051-14 |
| 10050-18 | 18 cm, 7"     | 10051-18 |

Blepharoplastik Scheren  
Blepharoplasty Scissors  
Tijeras para blefaroplastia  
Forbici per blefaroplastica



GREENBERG-PAR  
10201-11 11,5 cm 4<sup>1</sup>/<sub>2</sub>"  
**10201-11SC** 11,5 cm 4<sup>1</sup>/<sub>2</sub>"



KAYE  
10206-11 11,5 cm, 4<sup>1</sup>/<sub>2</sub>"  
**10206-11SC** 11,5 cm, 4<sup>1</sup>/<sub>2</sub>"  
10207-11  
**10207-11SC**



Mikro Scheren  
 Micro Scissors  
 Micro tijeras  
 Micro Forbice



10 mm

11 cm  
 4<sup>3</sup>/<sub>8</sub>"

10202-11

10203-11

14,5 cm  
 5<sup>3</sup>/<sub>4</sub>"

10202-14  
**10202-14T**

10203-14  
**10203-14T**

18 cm  
 7"

10202-18  
**10202-18T**

10203-18  
**10203-18T**

21 cm  
 8<sup>1</sup>/<sub>4</sub>"

10202-21  
**10202-21T**

10203-21  
**10203-21T**

23 cm  
 9"

10202-23

10203-23

T= Titan, titanium, titanio, titanio

Mikro Scheren  
Micro Scissors  
Micro tijeras  
Micro Forbice

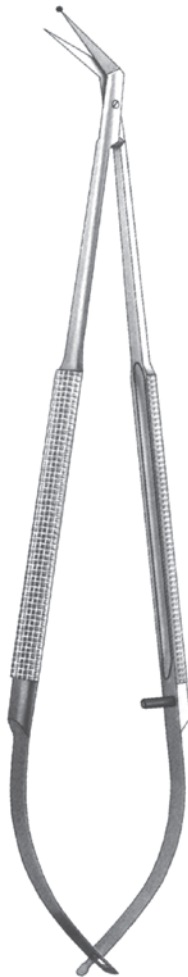

18 cm 7"



25°

10220-25

10220-25T



45°

10220-45

10220-45T

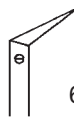

60°

10220-60

10220-60T

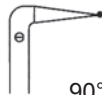

90°

10220-90

10220-90T



125°

10220-00



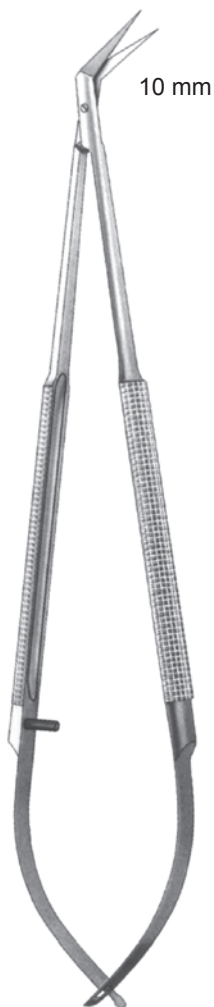

10220-00T

T= Titan, titanium, titanio, titanio

Mikro Scheren  
Micro Scissors  
Micro tijeras  
Micro Forbice









10 mm









|  | 11 cm<br>4 <sup>3</sup> / <sub>8</sub> " | 14,5 cm<br>5 <sup>3</sup> / <sub>4</sub> " | 18 cm<br>7"                  | 21 cm<br>8 <sup>1</sup> / <sub>4</sub> " | 23 cm<br>9" |
|--|--|--|------------------------------|--|-------------|
|  25°    | 10226-11                                 | 10226-14                                   | 10226-18<br><b>10226-18T</b> | 10226-21                                 | 10226-23    |
|  45°    | 10227-11                                 | 10227-14                                   | 10227-18<br><b>10227-18T</b> | 10227-21                                 | 10227-23    |
|  60°   | 10228-11                                 | 10228-14                                   | 10228-18<br><b>10228-18T</b> | 10228-21                                 | 10228-23    |
|  90°  | 10229-11                                 | 10229-14                                   | 10229-18<br><b>10229-18T</b> | 10229-21                                 | 10229-23    |
|  125° | 10230-11                                 | 10230-14                                   | 10230-18<br><b>10230-18T</b> | 10230-21                                 | 10230-23    |

T= Titan, titanium, titanio, titanio

Anatomische und chirurgische Pinzetten  
 Dressing and Tissue Forceps  
 Pinzas de disección sin/con dientes  
 Pinze per dissezione, chirurgiche/anatomiche

|      |   |  |   |   |
|------|--|---|--|--|
|      | STANDARD   |   | USA  | STILLE   |
| cm   |  |   |  |  |
| 10,5 | 4 1/4"   | 11102-10  |  |  |
| 11,5 | 4 1/2"   | 11102-11  |  |  |
| 12,0 | 4 3/4"   |   | 11104-12   |  |
| 13,0 | 5 1/8"   | 11102-13  | 11104-13   | 11106-13   |
| 14,5 | 5 3/4"   | 11102-14  | 11104-14   |  |
| 15,0 | 6"   |   |  | 11106-15   |
| 15,5 | 6"   |   | 11104-15   |  |
| 16,0 | 6 1/4"   | 11102-16  |  |  |
| 18,0 | 7"   | 11102-18  | 11104-18   |  |
| 20,0 | 8"   | 11102-20  |  |  |
| 21,0 | 8 1/4"   |   | 11104-21   |  |
|      |  |   |  |  |
|      | schmal<br>narrow<br>estrecha<br>stretta  |   | POTTS-SMITH  | POTTS-SMITH<br>1x2   |
| cm   |  |   |  |  |
| 11,5 | 4 1/2"   | 11110-11  |  |  |
| 13,0 | 5 1/8"   | 11110-13  |  |  |
| 14,5 | 5 3/4"   | 11110-14  | 11114-14 TC  |  |
| 16,0 | 6 1/4"   | 11110-16  | 11114-16 TC  |  |
| 18,0 | 7"   | 11110-18  | 11112-18   | 11116-18 TC  |
| 20,0 | 8"   | 11110-20  | 11114-20 TC  | 11126-18   |
| 21,0 | 8 1/4"   |   | 11112-21   | 11116-21 TC  |
| 25,0 | 10"  | 11110-25  | 11112-25   | 11116-25 TC  |
|      |  |   |  | 11126-21   |
|      |  |   |  | 11126-25   |

Chirurgische Pinzetten  
Tissue Forceps  
Pinzas de disección con dientes  
Pinze per dissezione, chirurgiche

| STANDARD    |  1x2 |  1x2  |  1x2  |  1x2   |
|-------------|---|--|--|---|
| cm          |   | USA  | STILLE   | schmal<br>narrow<br>estrecha<br>stretta   |
| 10,5 4 1/4" | 11120-10  |  |  |   |
| 11,5 4 1/2" | 11120-11  |  |  | 11130-11  |
| 12,0 4 3/4" |   | 11122-12   |  |   |
| 13,0 5 1/8" | 11120-13  | 11122-13   |  | 11130-13  |
| 14,5 5 3/4" | 11120-14  | 11122-14   |  | 11130-14  |
| 15,0 6"     |   |  | 11124-15   |   |
| 15,5 6"     |   | 11122-15   |  |   |
| 16,0 6 1/4" | 11120-16  |  |  | 11130-16  |
| 18,0 7"     | 11120-18  | 11122-18   |  | 11130-18  |
| 20,0 8"     | 11120-20  |  |  | 11130-20  |
| 21,0 8 1/4" |   | 11122-21   |  |   |
|             |    |  2x3 |  3x4 |  4x5 |
| cm          | OEHLER  |  |  |   |
| 11,5 4 1/2" |   | 11140-11   |  |   |
| 13,0 5 1/8" |   | 11140-13   | 11150-13   | 11160-13  |
| 14,5 5 3/4" |   | 11140-14   | 11150-14   | 11160-14  |
| 16,0 6 1/4" | 11132-16 TC   | 11140-16   | 11150-16   | 11160-16  |
| 18,0 7"     | 11132-18 TC   | 11140-18   |  |   |
| 20,0 8"     | 11132-20 TC   | 11140-20   |  |   |

Anatomische und chirurgische Pinzetten  
 Dressing and Tissue Forceps  
 Pinzas de disección sin/con dientes  
 Pinze per dissezione, chirurgiche/anatomiche



ADSON

11170-12 12,0 cm, 4<sup>3</sup>/<sub>4</sub>"  
 11170-15 15,0 cm, 6"



ADSON

11170-12F 12 cm, 4<sup>3</sup>/<sub>4</sub>"



ADSON

11174-12 TC 12,0 cm, 4<sup>3</sup>/<sub>4</sub>"  
 11174-15 TC 15,0 cm, 6"



ADSON micro

11176-12 12,0 cm, 4<sup>3</sup>/<sub>4</sub>"  
 11176-15 15,0 cm, 6"



ADSON-DeBAKEY atraumatic

11177-12  
 12,0 cm, 4<sup>3</sup>/<sub>4</sub>"



1x2

ADSON  
 11178-12  
 12,0 cm, 4<sup>3</sup>/<sub>4</sub>"



2x3

ADSON  
 11179-12  
 12 cm, 4<sup>3</sup>/<sub>4</sub>"

Chirurgische Pinzetten  
Tissue Forceps  
Pinzas de disección con dientes  
Pinze per dissezione, chirurgiche



1x2

ADSON

11180-12 12,0 cm, 4<sup>3</sup>/<sub>4</sub>"  
11180-15 15,0 cm, 6"



1x2

ADSON

11180-12F 12 cm, 4<sup>3</sup>/<sub>4</sub>"



1x2

ADSON

11181-12 TC 12,0 cm, 4<sup>3</sup>/<sub>4</sub>"  
11181-15 TC 15,0 cm, 6"



BEASELEY BABCOCK  
11182-12 12 cm, 4<sup>3</sup>/<sub>4</sub>"



1x2

ADSON micro  
11186-12 12,0 cm, 4<sup>3</sup>/<sub>4</sub>"  
11186-15 15,0 cm, 6"



1x2

ADSON  
11187-12 12 cm, 4<sup>3</sup>/<sub>4</sub>"

Chirurgische Pinzetten  
Tissue Forceps  
Pinzas de disección con dientes  
Pinze per dissezione, chirurgiche



7x7

ADSON-BROWN

11188-12 12,0 cm, 4<sup>3</sup>/<sub>4</sub>"

11188-15 15,0 cm, 6"

11189-12 TC 12,0 cm, 4<sup>3</sup>/<sub>4</sub>"



7x7

ADSON-BROWN

11188-12F 12 cm, 4<sup>3</sup>/<sub>4</sub>"

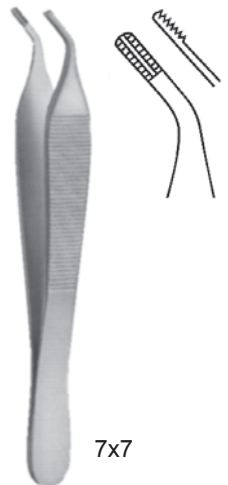

7x7

ADSON-BROWN

11191-12 12 cm, 4<sup>3</sup>/<sub>4</sub>"



Anatomische und chirurgische Pinzetten  
 Dressing and Tissue Forceps  
 Pinzas de disección sin/con dientes  
 Pinze per dissezione, chirurgiche/anatomiche



1x2

WAUGH

- 11187-18 18 cm, 7"
- 11187-20 20 cm, 8"
- 11187-25 25 cm, 10"
- 11187-30 30 cm, 11<sup>3</sup>/<sub>4</sub>"



9x9

BROWN

- 11189-15 15,0 cm, 6"
- 11189-20 20,0 cm, 8"
- 11189-25 25,0 cm, 10"



GRAEFE

- 11190-10 10,5 cm, 4.1"



11221-17

CUSHING  
 11220-17

- 11224-17 TC**  
 17,0 cm, 6<sup>3</sup>/<sub>4</sub>"



11223-17

CUSHING  
 11222-17

- 11225-17 TC**  
 17,0 cm, 6<sup>3</sup>/<sub>4</sub>"

1x2



5x6

LERCHE  
 11232-15  
 15,0 cm, 6"

Anatomische und chirurgische Pinzetten  
 Dressing and Tissue Forceps  
 Pinzas de disección sin/con dientes  
 Pinze per dissezione, chirurgiche/anatomiche



1x2

FERRIS-SMITH  
 11246-18  
 18,0 cm, 7"



2x3

FERRIS-SMITH  
 11248-18  
 18,0 cm, 7"



DUVAL  
 11250-14  
 14,5 cm, 5 3/4"



COLLIN-DUVAL  
 11252-20  
 20,0 cm, 8"



Russ. Mod.  
 11256-15 15,0 cm, 6"  
 11256-20 20,0 cm, 8"  
 11256-25 25,0 cm, 10"



1x2

McINDOE  
 11257-15  
 15,0 cm, 6"



McINDOE  
 11258-15 15,0 cm, 6"  
 11259-15 TC 15,0 cm, 6"

Anatomische und chirurgische Pinzetten  
 Dressing and Tissue Forceps  
 Pinzas de disección sin/con dientes  
 Pinze per dissezione, chirurgiche/anatomiche



SEMKEN

- 11260-12 12,5 cm, 5"
- 11260-15 15,5 cm, 6"
- 11261-15 TC 15,5 cm, 6"



1x2

SEMKEN

- 11270-12 12,5 cm, 5"
- 11270-15 15,5 cm, 6"
- 11271-15 TC 15,5 cm, 6"
- 11271-18 TC 18 cm, 7"



1x2

GILLIES

- 11272-15 15,5 cm, 6"
- 11273-15 TC 15,5 cm, 6"



15,5 cm, 6"



11274-06  
0,6 mm



11274-08  
0,8 mm



11274-10  
1,0 mm



GERALD

- 11302-17 17,5 cm, 6.9"
- 11302-23 23,0 cm, 9"
- 11304-17 TC 17,0 cm, 6<sup>3</sup>/<sub>4</sub>"



GERALD

- 11303-17  
17,5 cm, 6.9"

Anatomische und chirurgische Pinzetten  
 Dressing and Tissue Forceps  
 Pinzas de disección sin/con dientes  
 Pinze per dissezione, chirurgiche/anatomiche



GERALD  
 11305-17  
 17,5 cm, 6.9"



GERALD  
 11310-17 17,5 cm, 6.9"  
 11312-17 TC 17,5 cm, 6.9"



GERALD  
 11311-17  
 17,5 cm, 6.9"



CUSHING-TAYLOR  
 11312-18 TC  
 18,5 cm, 7 1/4"



GERALD  
 11313-17  
 17,5 cm, 6.9"



11314-01



TAYLOR  
 17 cm, 6 3/4"



11314-02



11315-01



TAYLOR  
 17 cm, 6 3/4"



11315-02

Anatomische und chirurgische Pinzetten  
 Dressing and Tissue Forceps  
 Pinzas de disección sin/con dientes  
 Pinze per dissezione, chirurgiche/anatomiche

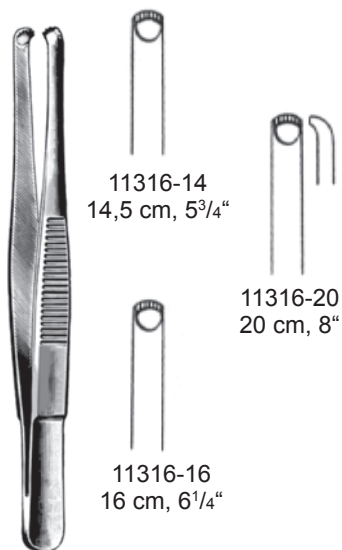

11316-14  
14,5 cm, 5<sup>3</sup>/<sub>4</sub>"

11316-16  
16 cm, 6<sup>1</sup>/<sub>4</sub>"

11316-20  
20 cm, 8"

DURANTE

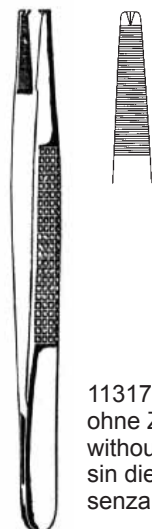

11317-00  
ohne Zähne  
without teeth  
sin dientes  
senza denti

11317-12 1x2  
11317-23 2x3  
11319-12 TC 1x2

BONNEY  
18 cm, 7"

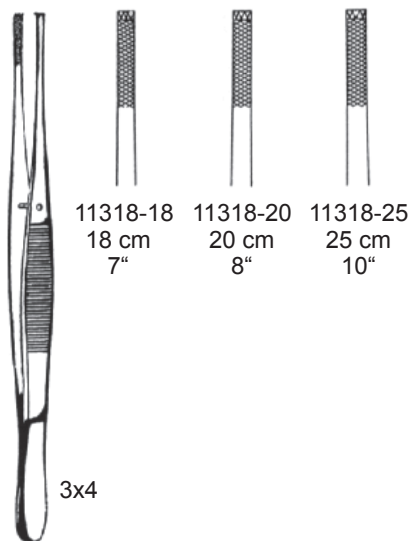

11318-18  
18 cm  
7"

11318-20  
20 cm  
8"

11318-25  
25 cm  
10"

3x4

STILLE-BARRAYA



OCHSNER  
11319-14  
14,5 cm, 5<sup>3</sup>/<sub>4</sub>"



SINGLEY  
11320-18 18 cm, 7"  
11320-23 23 cm, 9"

Splitterpinzetten  
Splinter Forceps  
Pinzas para espinas  
Pinze per schegge

Fig.: 1



11401-01  
12 cm, 4<sup>3</sup>/<sub>4</sub>"

3



11403-03  
12 cm, 4<sup>3</sup>/<sub>4</sub>"

3c



11403-04  
11 cm, 4<sup>3</sup>/<sub>8</sub>"

Fig.: 4



11404-04  
11 cm, 4<sup>3</sup>/<sub>8</sub>"

5



11405-05  
11 cm, 4<sup>3</sup>/<sub>8</sub>"

7



11407-07  
12 cm, 4<sup>3</sup>/<sub>4</sub>"

mit Führungsstift  
with guide pin

Mikro- Knüpppinzetten  
Micro Suture Tying Forceps  
Micro pinzas para ligaduras  
Micro pinze per legature

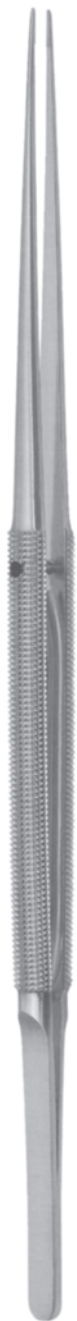

1x2



1x2

|  | 0,3 mm                | 0,7 mm                |
|--|-----------------------|-----------------------|
| 12 cm, 4 <sup>3</sup> / <sub>4</sub> " | 12102-12<br>12102-12D |                       |
|  | 12102-12T             | 12108-12T             |
| 15 cm, 6"                              | 12104-15<br>12104-15D |                       |
|  | 12104-15T             | 12108-15T             |
| 18 cm, 7"                              |                       | 12108-18<br>12108-18D |
|  | 12104-18T             | 12108-18T             |
| 21 cm, 8 <sup>1</sup> / <sub>4</sub> " |                       | 12102-21<br>12102-21D |
|  | 12104-21T             | 12108-21T             |
| 23 cm, 9"                              |                       | 12102-23<br>12102-23D |
|  | 12104-23T             | 12108-23T             |

|  | 0,3 mm                | 0,7 mm                |
|--|-----------------------|-----------------------|
| 12 cm, 4 <sup>3</sup> / <sub>4</sub> " | 12103-12<br>12103-12D |                       |
| 15 cm, 6"                              | 12103-15<br>12103-15D |                       |
| 18 cm, 7"                              |                       | 12109-18<br>12109-18D |
| 21 cm, 8 <sup>1</sup> / <sub>4</sub> " |                       | 12109-21<br>12109-21D |
| 23 cm, 9"                              |                       | 12109-23<br>12109-23D |

|  | 0,3 mm    | 0,3 mm    |
|--|-----------|-----------|
| 15 cm, 6"                              | 12090-15D | 12091-15D |
| 18 cm, 7"                              | 12090-18D | 12091-18D |
|  | 0,8 mm    | 0,8 mm    |
| 21 cm, 8 <sup>1</sup> / <sub>4</sub> " | 12090-21D | 12091-21D |
| 23 cm, 9"                              | 12090-23D | 12091-23D |

D = mit diamantiertem Maul  
with diamond jaw  
con boca de diamante  
con morso diamantato  
T = Titan, titanium, titanio, titanio

Mikro- Ring-Pinzette mit diamantiertem Maul + TITAN  
 Micro Ring Forceps with Diamond Jaw + Titanium  
 Micro Pinzas con anillo con boca de diamante + Titanio  
 Micro Pinza ad anello con morso diamantato +Titanio



|  | Ø<br>1 mm x 0,5 mm     | Ø<br>2 mm x 1 mm       |
|--|------------------------|------------------------|
| 15 cm, 6"                              | 12112-15D<br>12112-15T | 12114-15D<br>12114-15T |
| 18 cm, 7"                              | 12112-18D<br>12112-18T | 12114-18D<br>12114-18T |
| 21 cm, 8 <sup>1</sup> / <sub>4</sub> " | 12112-21D<br>12112-21T | 12114-21D<br>12114-21T |
| 23 cm, 9"                              | 12112-23D<br>12112-23T | 12114-23D<br>12114-23T |

D = mit diamantiertem Maul  
 with diamond jaw  
 con boca de diamante  
 con morso diamantato  
 T = Titan, titanium, titanio, titanio



Atrauma- Mikro- Pinzette  
 Atrauma Micro Forceps  
 Micro pinza atraumaticas  
 Micro Pinza Atraumatica

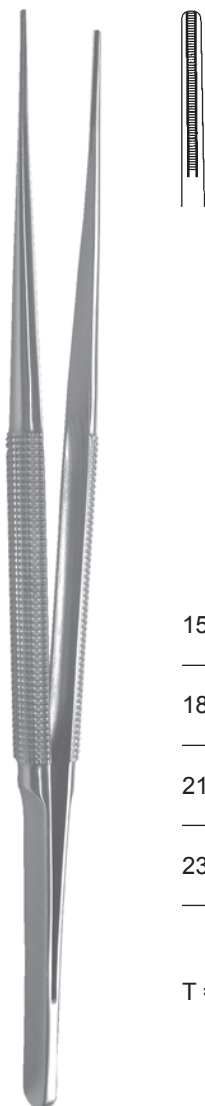

|  | 1,2 mm                | 2,0 mm   |
|--|-----------------------|----------|
| 15 cm, 6"                              | 12115-15<br>12115-15T | 12116-15 |
| 18 cm, 7"                              | 12115-18<br>12115-18T | 12116-18 |
| 21 cm, 8 <sup>1</sup> / <sub>4</sub> " | 12115-21<br>12115-21T | 12116-21 |
| 23 cm, 9"                              | 12115-23<br>12115-23T | 12116-23 |

T = Titan, titanium, titanio, titanio

De BAKEY

TC Atrauma Pinzette  
TC Atrauma Forceps  
Pinza atraumaticas con TC  
Pinza Atraumatica TC



|               | 1,2 mm      | 2,0 mm      |
|---------------|-------------|-------------|
| 18 cm, 7"     | 12117-18 TC | 12118-18 TC |
| 21 cm, 8 1/4" | 12117-21 TC | 12118-21 TC |
| 23 cm, 9"     | 12117-23 TC | 12118-23 TC |

De BAKEY TC

Atraumatische Pinzetten  
 Atraumatic Tissue Forceps  
 Pinzas atraumaticas  
 Pinze Atraumatiche



DE BAKEY  
 12302-16 16 cm, 6 1/4"  
 12302-20 20 cm, 8"  
 12302-24 24 cm, 9 1/2"



DE BAKEY  
 12306-16 16 cm, 6 1/4"  
 12306-20 20 cm, 8"  
 12306-24 24 cm, 9 1/2"  
 12306-30 30 cm, 11 3/4"



DE BAKEY  
 12308-16 16 cm, 6 1/4"  
 12308-20 20 cm, 8"  
 12308-24 24 cm, 9 1/2"  
 12308-30 30 cm, 11 3/4"



DE BAKEY  
 12309-16 16 cm, 6 1/4"  
 12309-20 20 cm, 8"  
 12309-24 24 cm, 9 1/2"  
 12309-30 30 cm, 11 3/4"



DE BAKEY  
 12304-16 16 cm, 6 1/4"  
 12304-20 20 cm, 8"  
 12304-24 24 cm, 9 1/2"  
 12304-30 30 cm, 11 3/4"

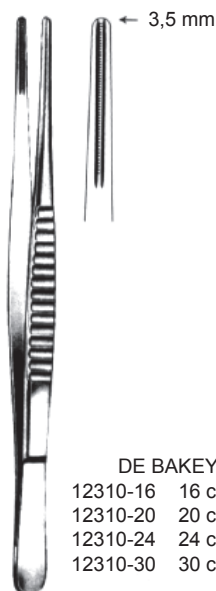

DE BAKEY  
 12310-16 16 cm, 6 1/4"  
 12310-20 20 cm, 8"  
 12310-24 24 cm, 9 1/2"  
 12310-30 30 cm, 11 3/4"

Iris Pinzetten  
Iris Forceps  
Pinzas para iris  
Pinze per iride



GRAEFE  
43810-10  
10 cm, 4"



GRAEFE  
43811-10  
10 cm, 4"



GRAEFE  
43813-10  
10 cm, 4"



GRAEFE  
43820-10  
10 cm, 4"



GRAEFE  
43821-10  
10 cm, 4"



GRAEFE  
43823-10  
10 cm, 4"

Iris Pinzetten  
Iris Forceps  
Pinzas para iris  
Pinze per iride



BISHOP-HARMAN  
43940-05 8,5 cm, 3.4"  
0,5 mm



BISHOP-HARMAN  
43940-08 8,5 cm, 3.4"  
0,8 mm



BISHOP-HARMAN  
43942-05 8,5 cm, 3.4"  
0,5 mm



BISHOP-HARMAN  
43942-08 8,5 cm, 3.4"  
0,8 mm

Nahtpinzetten  
Suture forceps  
Pinzas para sutura  
Pinza per sutura



MOD. TUEBINGEN  
43950-10  
10 cm, 4"



MOD. BONN  
43952-10  
10 cm, 4" / 0,12 mm



MOD. TUEBINGEN  
43953-10  
10 cm, 4"

Muskelpinzetten, Nahtpinzetten, Chalazionspinzetten, Cilienpinzetten  
 Muscle Forceps, Suture forceps, Forceps for Chalazion, Cilia Forceps  
 Pinzas musculares, Pinza para sutura, Pinzas de chalazión, Pinza depilatoria  
 Pinza muscolare, Pinza per sutura, Pinze per calazio, Pinza depilatoria



**BERKE**  
 10 cm, 4"

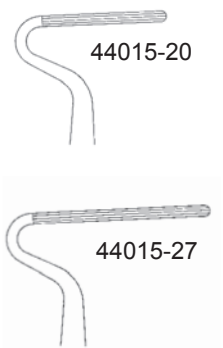

**CASTROVIEJO**  
 10 cm, 4"

auch mit breitem Griff verfügbar  
 also available with broad handle  
 también disponible con apoyo ancho  
 disponibile con impugnatura larga

- 44150-01 0,12 mm
- 44150-03 0,30 mm
- 44150-05 0,50 mm
- 44150-10 1,00 mm
- 44150-15 1,50 mm



**DESMARRES**  
 9 cm, 3 1/2"

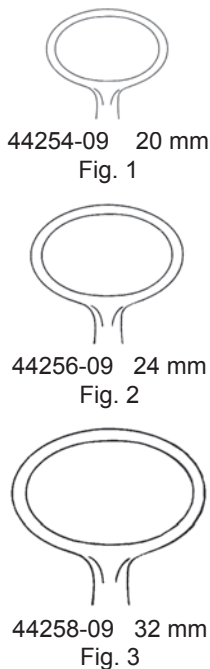

**BARRAQUER**  
 44425-10 10,5 cm, 4.1"

Fixierpinzetten  
Fixation forceps  
Pinzas para fijación  
Pinze fissatrici



GREEN  
10 cm, 4"

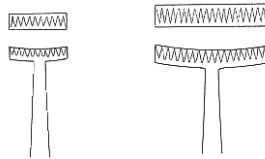

44076-05  
5 mm

44076-10  
10 mm

ohne Sperre  
without catch  
sin cierre  
senza cremagliera

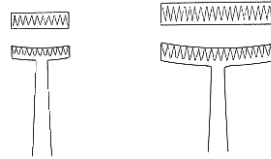

44078-05  
5 mm

44078-10  
10 mm

mit Sperre  
with catch  
con cierre  
con cremagliera



Ohrpinzetten, Columellapinzette  
 Ear Forceps, Columella Forceps  
 Pinzas auriculares, Pinza para columela  
 Pinze auricolari, Pinza per columella



WILDE (TROELTSCH)  
 45201-11 11 cm, 4<sup>3</sup>/<sub>8</sub>"



LUCAE  
 45206-14 14 cm, 5<sup>1</sup>/<sub>2</sub>"  
 45206-16 16 cm, 6<sup>1</sup>/<sub>4</sub>"



COTTLE  
 45208-14 14 cm, 5<sup>1</sup>/<sub>2</sub>"



TROELTSCH  
 47151-15 15 cm, 6"  
 47151-18 18 cm, 7"



JANSEN-GRUENWALD  
 47154-20 20 cm, 8"



COTTLE  
 47565-10 10 cm, 4"

Lidplatte  
Lid Plate  
Placa para párado  
Placca per palpebre



JAEGER  
43150-11 11 cm, 4<sup>3</sup>/<sub>8</sub>"

Arterienklemmen  
Artery Forceps  
Pinzas hemostáticas  
Pinze emostatiche



HARTMANN  
13210-10 10 cm, 4"

Micro - HARTMANN  
13214-10 10 cm, 4"



HARTMANN  
13211-10 10 cm, 4"

Micro - HARTMANN  
13215-10 10 cm, 4"

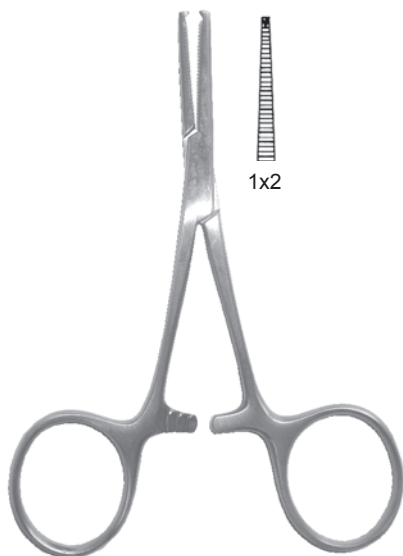

HARTMANN  
13212-10 10 cm, 4"

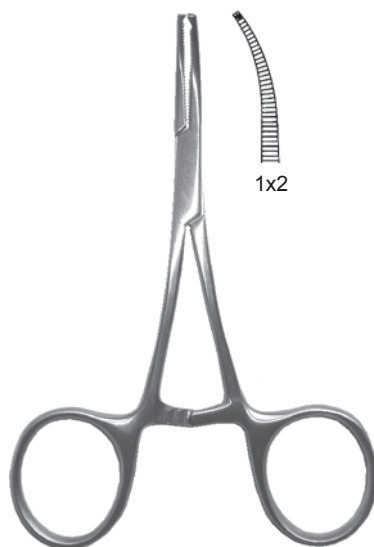

HARTMANN  
13213-10 10 cm, 4"

Arterienklemmen  
 Artery Forceps  
 Pinzas hemostáticas  
 Pinze emostatiche



HALSTED-MOSQUITO

- |                  |          |                 |          |                  |
|------------------|----------|-----------------|----------|------------------|
| <b>13224-12T</b> | 13220-12 | 12,5 cm, 5"     | 13221-12 | <b>13225-12T</b> |
|                  | 13220-14 | 14,0 cm, 5 1/2" | 13221-14 |                  |
|                  | 13220-18 | 18,0 cm, 7"     | 13221-18 |                  |
|                  | 13220-21 | 21,0 cm, 8 1/4" | 13221-21 |                  |

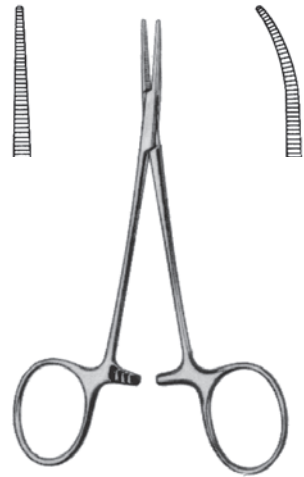

HALSTED-MOSQUITO micro

- |                |             |          |
|----------------|-------------|----------|
| 13222-12       | 12,5 cm, 5" | 13223-12 |
| JACOBSEN micro |             |          |
| 13226-12       | 12,5 cm, 5" | 13227-12 |

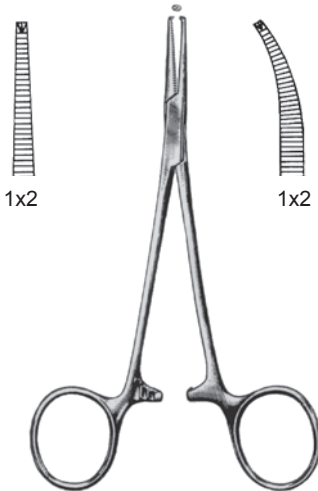

HALSTED-MOSQUITO

- |          |                 |          |
|----------|-----------------|----------|
| 13230-12 | 12,5 cm, 5"     | 13231-12 |
| 13230-14 | 14,0 cm, 5 1/2" | 13231-14 |
| 13230-18 | 18,0 cm, 7"     | 13231-18 |
| 13230-21 | 21,0 cm, 8 1/4" | 13231-21 |

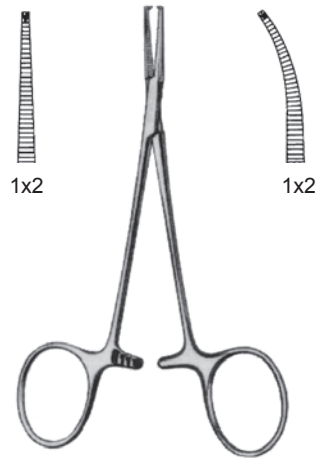

HALSTED-MOSQUITO micro

- |          |             |          |
|----------|-------------|----------|
| 13232-12 | 12,5 cm, 5" | 13233-12 |
|----------|-------------|----------|

Arterienklemmen  
 Artery Forceps  
 Pinzas hemostáticas  
 Pinze emostatiche

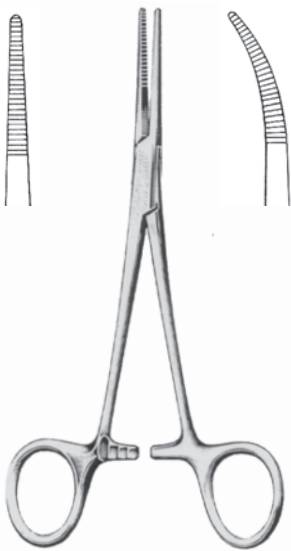

KELLY

- |          |               |          |
|----------|---------------|----------|
| 13240-14 | 14 cm, 5 1/2" | 13241-14 |
| 13240-18 | 18 cm, 7"     | 13241-18 |
| 13244-14 | 14 cm, 5 1/2" | 13245-14 |

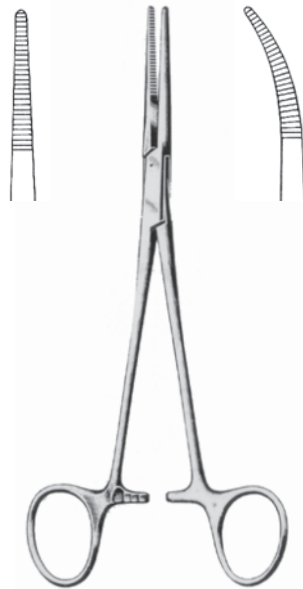

KELLY-RANKIN

- |          |               |          |
|----------|---------------|----------|
| 13242-16 | 16 cm, 6 1/4" | 13243-16 |
|----------|---------------|----------|

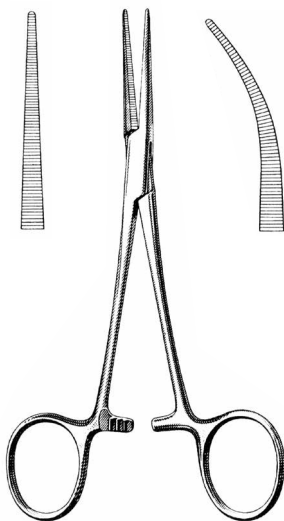

COLLER-CRILE

- |          |               |          |
|----------|---------------|----------|
| 13256-14 | 14 cm, 5 1/2" | 13257-14 |
| 13258-16 | 16 cm, 6 1/4" | 13259-16 |

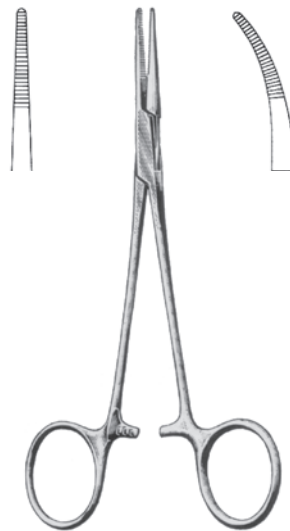

PROVIDENCE-HOSPITAL

- |          |               |          |
|----------|---------------|----------|
| 13270-14 | 14 cm, 5 1/2" | 13271-14 |
|----------|---------------|----------|

Arterienklemmen  
 Artery Forceps  
 Pinzas hemostáticas  
 Pinze emostatiche

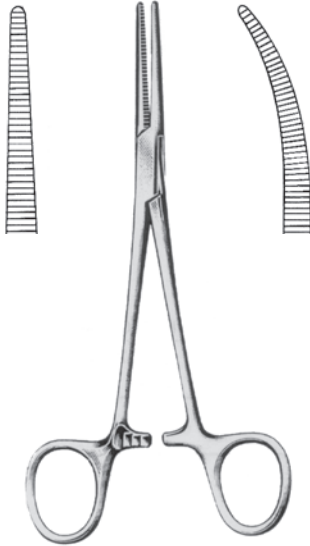

CRILE  
 13250-14 14 cm, 5 1/2" 13251-14  
 13250-18 18 cm, 7" 13251-18  
 13254-14 14 cm, 5 1/2" 13255-14

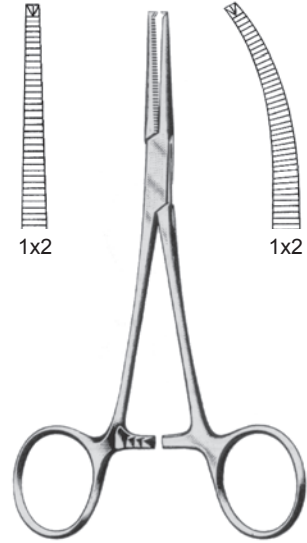

CRILE  
 13260-14 14 cm, 5 1/2" 13261-14

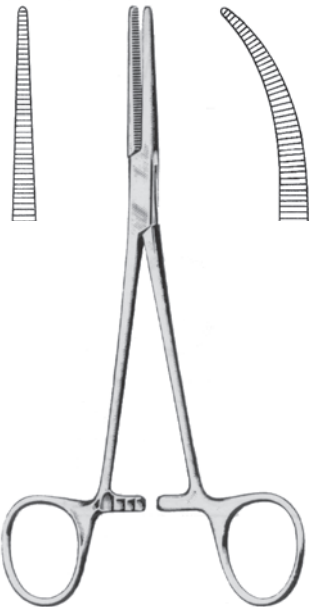

CRILE-RANKIN  
 13262-16 16 cm, 6 1/4" 13263-16

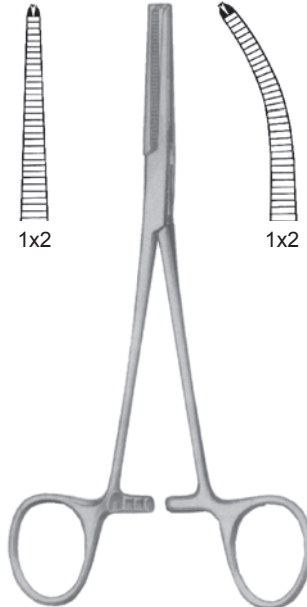

CRILE-RANKIN  
 13264-16 16 cm, 6 1/4" 13265-16

Arterienklemmen  
 Artery Forceps  
 Pinzas hemostáticas  
 Pinze emostatiche

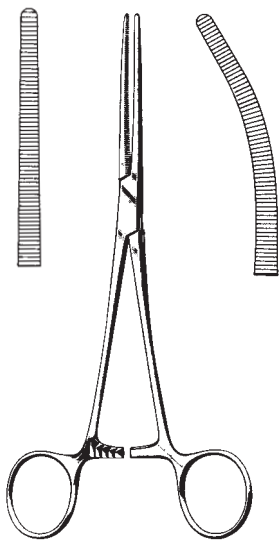

ROCHESTER-PEAN

- 13310-13 13,0 cm, 5<sup>1</sup>/<sub>8</sub>" 13311-13  
 13310-14 14,0 cm, 5<sup>1</sup>/<sub>2</sub>" 13311-14  
 13310-16 16,0 cm, 6<sup>1</sup>/<sub>4</sub>" 13311-16

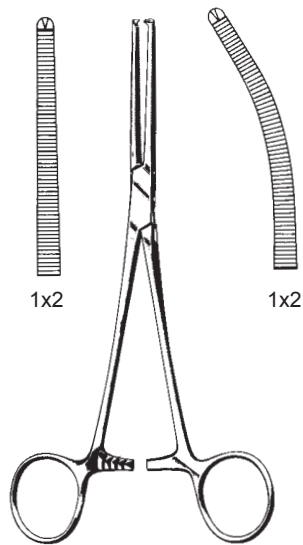

ROCHESTER-OGHSNER

- 13320-13 13,0 cm, 5<sup>1</sup>/<sub>8</sub>" 13321-13  
 13320-14 14,0 cm, 5<sup>1</sup>/<sub>2</sub>" 13321-14  
 13320-16 16,0 cm, 6<sup>1</sup>/<sub>4</sub>" 13321-16

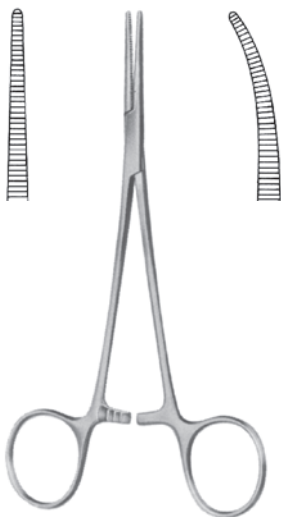

LERICHE

- 13380-15 15 cm, 6" 13381-15

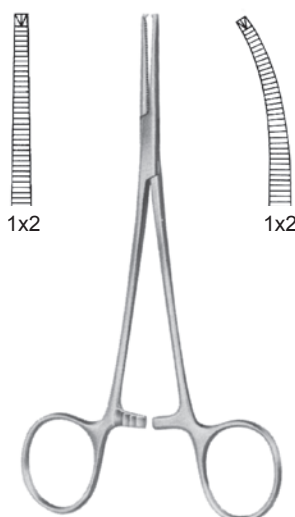

LERICHE

- 13382-15 15 cm, 6" 13383-15

Arterienklemmen  
Artery Forceps  
Pinzas hemostáticas  
Pinze emostatiche

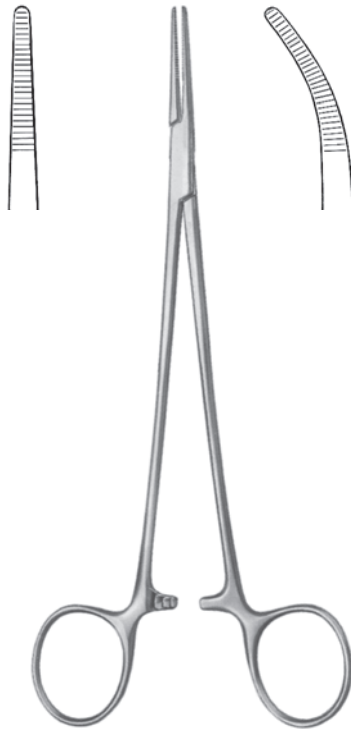

ADSON  
13410-18    18,5 cm, 7<sup>1</sup>/<sub>4</sub>"    13411-18



Wundhaken  
Retractors  
Separadores  
Divaricatori

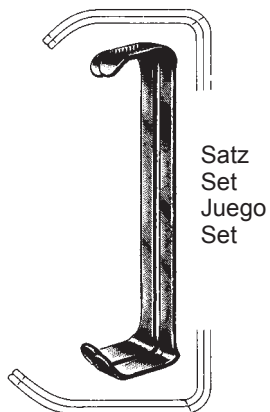

Satz  
Set  
Juego  
Set

FARABEUF  
19102-12  
12 cm, 4<sup>3</sup>/<sub>4</sub>"

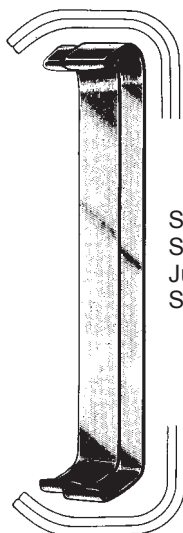

Satz  
Set  
Juego  
Set

FARABEUF  
19102-15  
15 cm, 6"



ROUX mini  
19124-15  
14 cm, 5<sup>1</sup>/<sub>2</sub>"



RAGNELL  
19125-14  
14 cm, 5<sup>1</sup>/<sub>2</sub>"

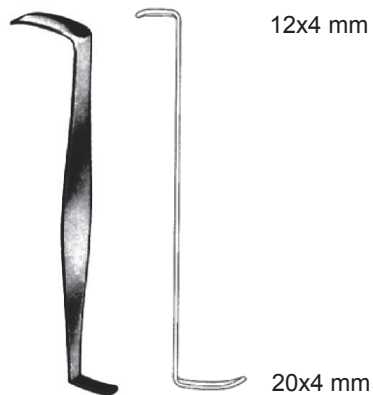

CRILE  
19127-11  
11 cm, 4<sup>1</sup>/<sub>2</sub>"

Bauch- und Darmspatel  
Abdominal and Intestinal Spatulas  
Espátulas abdominales e intestinales  
Spatole addominali e intestinali

biegsam  
malleable  
maleables  
malleabili



RIBBON

|          |           |
|----------|-----------|
| 19168-06 | 6x200 mm  |
| 19168-08 | 8x200 mm  |
| 19168-10 | 10x200 mm |
| 19168-12 | 12x200 mm |
| 19168-17 | 17x200 mm |
| 19168-20 | 20x200 mm |
| 19168-25 | 25x200 mm |
| 19169-25 | 25x250 mm |



RIBBON

|          |           |
|----------|-----------|
| 19170-20 | 20x330 mm |
| 19170-25 | 25x330 mm |
| 19170-32 | 32x330 mm |
| 19170-40 | 40x330 mm |
| 19170-45 | 45x330 mm |
| 19170-50 | 50x330 mm |
| 19170-65 | 65x330 mm |
| 19170-76 | 76x330 mm |

Wundhaken  
Retractors  
Separadores  
Divaricatori



19 mm

DEAVER  
19180-19  
19 cm, 7 $\frac{1}{2}$ "



22 mm

DEAVER  
19181-22  
21,5 cm, 8 $\frac{1}{2}$ "

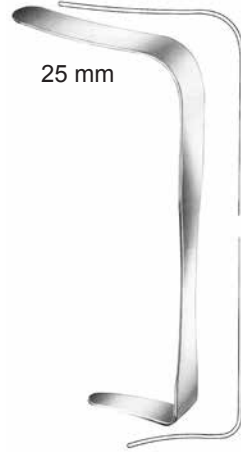

25 mm

DEAVER  
19181-25  
23 cm, 9"



25 mm

DEAVER  
19183-25  
30 cm, 11 $\frac{3}{4}$ "



25 mm

DEAVER  
19185-25  
33 cm, 13"



25 mm

DEAVER  
19187-25  
36 cm, 14"

Wundhaken  
Retractors  
Separadores  
Divaricatori

25 mm

CL = mit Kaltlicht  
with cold light  
con luz fria  
con luce fredda



FREEMAN  
20 cm/8"

12 mm 19188-12 19188-12CL  
25 mm 19188-25 19188-25CL



CL = mit Kaltlicht  
with cold light  
con luz fria  
con luce fredda

DEAVER  
19183-25CL  
30 cm/12"

Feine Wundhaken  
Retractors  
Separadores  
Divaricatori



GRAEFE  
19210-12

scharf  
sharp  
agudo  
acuto



GRAEFE  
19211-12

stumpf  
blunt  
romo  
smusso



12 cm, 4<sup>3</sup>/<sub>4</sub>"



GUTHRIE  
19212-01

scharf  
sharp  
agudo  
acuto



GUTHRIE  
19212-02



scharf  
sharp  
agudo  
acuto

TYRELL  
19213-12  
12 cm, 4<sup>3</sup>/<sub>4</sub>"

Feine Wundhaken  
 Retractors  
 Separadores  
 Divaricatori



FRAZIER

|   |        |   |        |
|---|--------|---|--------|
| A | scharf | B | stumpf |
| A | sharp  | B | blunt  |
| A | agudo  | B | romo   |
| A | acuto  | B | smusso |

|   |          |  |
|---|----------|--|
| A | 19214-13 | 13 cm, 5 <sup>1</sup> / <sub>8</sub> " |
| A | 19214-18 | 18 cm, 7"                              |
| B | 19215-13 | 13 cm, 5 <sup>1</sup> / <sub>8</sub> " |
| B | 19215-18 | 18 cm, 7"                              |



LAHEY  
 12 cm, 4<sup>3</sup>/<sub>4</sub>"

19215-01



19215-02



19215-03



JOSEPH  
 16 cm, 6<sup>1</sup>/<sub>4</sub>"



19216-01  
 1 mm



19216-02  
 2 mm



19216-05  
 5 mm



19216-07  
 7 mm



19216-10  
 10 mm



KLEINERT-KUTZ  
 13 cm, 5<sup>1</sup>/<sub>8</sub>"



19217-03



19217-05



19217-07

Feine Wundhaken  
Retractors  
Separadores  
Divaricatori



BARSKY  
19218-01  
15 cm, 6"



BARSKY  
19218-02  
15 cm, 6"



HUMBY  
19218-11  
11,5 cm, 4<sup>1</sup>/<sub>2</sub>"

Wundhaken  
Retractors  
Separadores  
Divaricatori

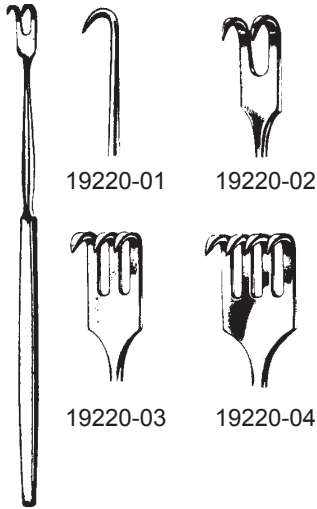

19220-01

19220-02

19220-03

19220-04

REDA  
16 cm, 6 1/4"

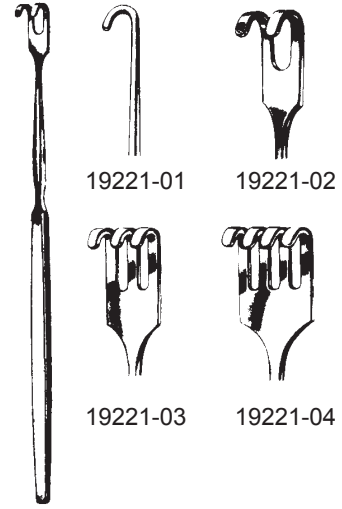

19221-01

19221-02

19221-03

19221-04

REDA  
16 cm, 6 1/4"

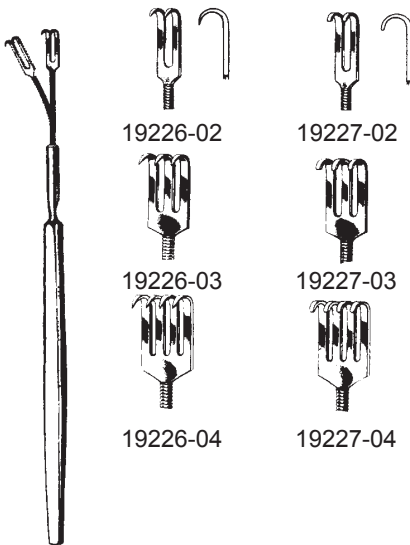

19226-02

19227-02

19226-03

19227-03

19226-04

19227-04

REDA, flexibel  
16 cm, 6 1/4"



19229-02

19229-03

KLAPP  
17,5 cm, 6.9"



Wundhaken  
Retractors  
Separadores  
Divaricatori



DESMARRES  
19230-00 16 cm, 6 1/4"



19230-10 10 mm

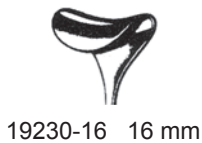

19230-16 16 mm



19230-12 12 mm



19230-18 18 mm



19230-14 14 mm



DESMARRES  
19234-00 14 cm, 5 1/2"



KASDAN  
19237-16 16 cm, 6 1/4"



VOLKMANN  
11,5 cm, 4 1/2"



19270-02



19271-02



19270-03



19271-03



19270-04



19271-04



19270-06



19271-06

Wundhaken  
Retractors  
Separadores  
Divaricatori



MEYERDING  
18 cm, 7"



19302-01 18x7 mm



19302-04 7x4 mm



19302-02 16x5 mm



19302-05 10x3 mm



19302-03 7x4 mm



19302-06 10x4 mm



STRANDELL-STILLE  
17 cm, 6<sup>3</sup>/<sub>4</sub>"



19307-01



19307-02

Wundsperrer  
Retractors  
Separadores  
Divaricatori

3x4



spitz  
sharp  
agudo  
acuto

stumpf  
blunt  
romo  
smusso

FINSEN

19610-07

7 cm, 2<sup>3</sup>/<sub>4</sub>"

19611-07

4x4



spitz  
sharp  
agudo  
acuto

stumpf  
blunt  
romo  
smusso

ALM

19620-07

7 cm, 2<sup>3</sup>/<sub>4</sub>"

19621-07

19620-10

10 cm, 4"

19621-10

3x3



spitz  
sharp  
agudo  
acuto

stumpf  
blunt  
romo  
smusso

JANSEN

19630-10

10 cm, 4"

19631-10

4x4



spitz  
sharp  
agudo  
acuto

stumpf  
blunt  
romo  
smusso

HOLZHEIMER

19634-10

10 cm, 4"

19635-10

Wundsperrer  
Retractors  
Separadores  
Divaricatori

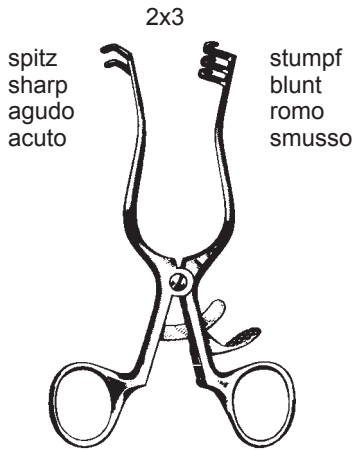

WEITLANER  
19650-10 11,5 cm, 4 1/2" 19651-10

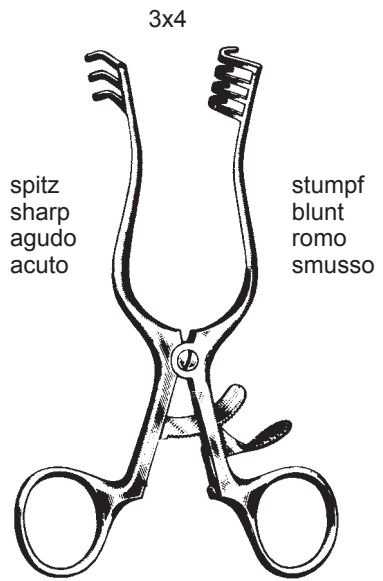

WEITLANER  
19670-14 14 cm, 5 1/2" 19671-14

Endo Dissektoren  
Endo dissectors  
Disectores  
Dissettori



24 cm, 9 1/2"



19741-01 LANGENBECK, 5,0 mm  
19741-02 LANGENBECK, 7,0 mm  
19741-03 LANGENBECK, 10,0 mm



19741-04 LANGENBECK, 5,0 mm  
19741-05 LANGENBECK, 7,0 mm  
19741-06 LANGENBECK, 10,0 mm



19741-07 LANGENBECK, 12,5 mm



19741-08 LANGENBECK-COTTLE 7,0 mm



19741-09 LANGENBECK-COTTLE, 7,0 mm



19741-10 LANGENBECK  
konkav, concave, concavo, concavo



19741-11 Mini-LANGENBECK



Nervenhaken / nerve hook  
gancho para nervios / uncino p. nervi

19741-12 links / left / izquierda / sinistra  
19741-13 rechts / right / derecha / destra

Wundhaken für plastische Chirurgie  
Retractors for plastic surgery  
Separadores para cirugía plástica  
Divaricatore per chirurgia plastica



mit Kaltlicht + Absaugung  
with cold light + aspiration  
con luz fría + aspiracion  
con luce fredda + aspirazione

FERRIERA

- 19960-01 80 mm x 16 mm
- 19960-02 100 mm x 25 mm
- 19960-03 120 mm x 25 mm
- 19960-04 120 mm x 30 mm
- 19960-05 150 mm x 25 mm
- 19960-06 150 mm x 30 mm
- 19960-07 150 mm x 36 mm

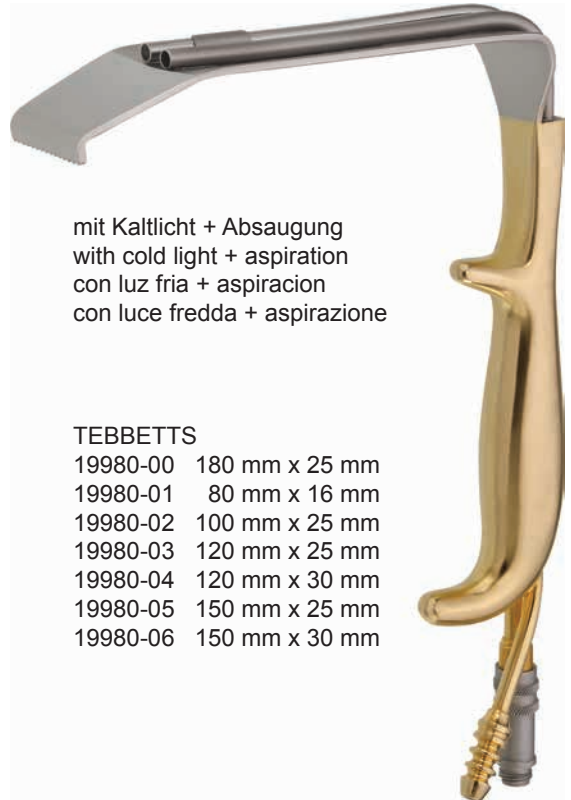

mit Kaltlicht + Absaugung  
with cold light + aspiration  
con luz fría + aspiracion  
con luce fredda + aspirazione

TEBBETTS

- 19980-00 180 mm x 25 mm
- 19980-01 80 mm x 16 mm
- 19980-02 100 mm x 25 mm
- 19980-03 120 mm x 25 mm
- 19980-04 120 mm x 30 mm
- 19980-05 150 mm x 25 mm
- 19980-06 150 mm x 30 mm

Wundhaken für plastische Chirurgie  
 Retractors for plastic surgery  
 Separadores para cirugía plástica  
 Divaricatore per chirurgia plastica



180 x 25 mm

passend für 10 mm Optik  
 for 10 mm scope  
 para óptica de 10 mm  
 per ottica 10 mm

Ø 10 mm

19999-10

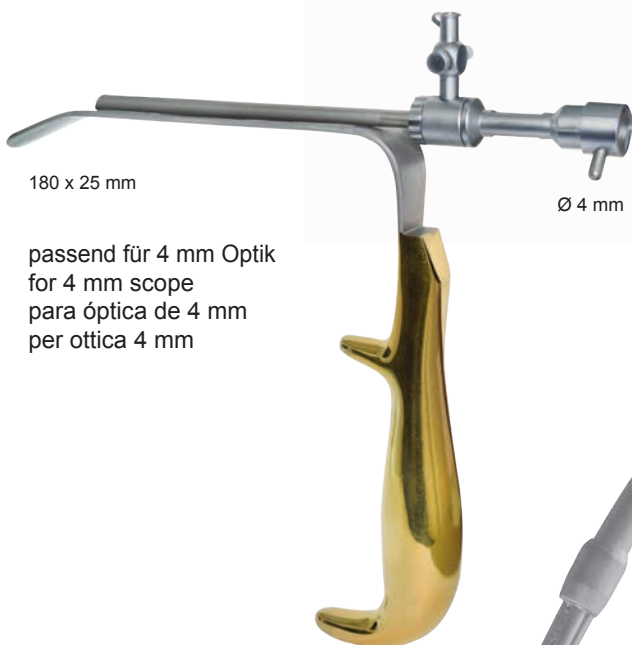

180 x 25 mm

passend für 4 mm Optik  
 for 4 mm scope  
 para óptica de 4 mm  
 per ottica 4 mm

Ø 4 mm

19999-40



CL = mit Kaltlicht + Absaugung  
 with cold light + aspiration  
 con luz fria + aspiracion  
 con luce fredda + aspirazione

BIGGS

|             |       |
|-------------|-------|
| 19999-30    | 30 mm |
| 19999-50    | 50 mm |
| 19999-30 CL | 30 mm |
| 19999-50 CL | 50 mm |

Spatel  
Spatula  
Espatula  
Spatola

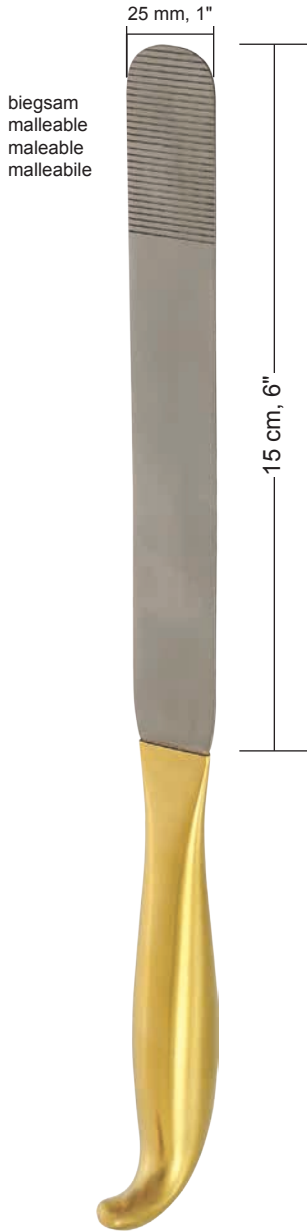

19992-31  
31,5 cm, 12 1/2"



BREAST  
19970-23 23,0 cm, 9" 34 x 100 cm, 20 x 60 cm  
19970-24 24,0 cm, 9 1/2" 38 x 70 cm, 22 x 55 cm  
19970-01 31,5 cm, 12 1/2" 38 x 70 cm, 20 x 55 cm



Brustdissektoren  
Breast Dissectors  
Separadores mamarios  
Separatori mammari

Satz  
Set  
Juego  
Set

graduiert  
graduated  
graduado  
graduato



AGRIS-DINGMAN  
19999-00  
36 cm, 14"

MacCOLLUM-DINGMAN  
19999-01 41 cm, 16"  
19999-31 31,5 cm, 12 1/2"

TEBBETTS  
19999-02  
33 cm, 13"

TEBBETTS  
19999-03  
33 cm, 13"

REYNOLDS  
(Transauxillary)  
19999-05  
40 cm, 16"

Brustdissektoren  
 Breast Dissectors  
 Separadores mamarios  
 Separatori mammari



SILVERSTEIN  
 19999-04  
 35,5 cm, 14"

LOCKWOOD  
 19999-06  
 38 cm, 15"

19989-22 22,0 cm, 8<sup>3</sup>/<sub>4</sub>"  
 19989-29 29,5 cm, 9<sup>1</sup>/<sub>2</sub>"

19999-22 22,0 cm, 8<sup>3</sup>/<sub>4</sub>"  
 19999-29 29,5 cm, 9<sup>1</sup>/<sub>2</sub>"

Wundhaken für plastische Chirurgie  
Retractors for plastic surgery  
Separadores para cirugía plástica  
Divaricatore per chirurgia plastica



YANCOSKIE  
19990-18  
18 cm, 7"



YANCOSKIE  
19991-18  
18 cm, 7"

Wundhaken für plastische Chirurgie  
 Retractors for plastic surgery  
 Separadores para cirugía plástica  
 Divaricatore per chirurgia plastica



**CORONAL**  
 19980-18  
 18 cm, 7"



**FREEMAN**  
 18 cm, 7"



19995-22  
 22 mm

19995-38  
 38 mm



**FREEMAN**  
 19996-18  
 18 cm, 7"

3 Finger  
 3 prongs  
 3 dientes  
 3 rebbi



5 Finger  
 5 prongs  
 5 dientes  
 5 rebbi

**ANDERSON**  
 19998-03 11 cm, 4 1/2" 19998-05



**GORNEY**  
 19996-04  
 7,5 cm, 3"



**FREEMAN**  
 19997-09  
 10 cm, 4"

rechts  
 right  
 derecho  
 destro

19998-01

rechts  
 right  
 derecho  
 destro

19998-11

18 mm



**MILLARD**

18 mm



**MILLARD**

links  
 left  
 izquierda  
 sinistra

19998-02

links  
 left  
 izquierda  
 sinistra

19998-12

Nervenhaken, Durahaken  
Nerve Hooks, Dura Hooks  
Ganchos para nervios y para duramadre  
Unicini per nervi e per dura-madre



CRILE  
41054-20  
20 cm, 8"



CUSHING  
41056-18  
18 cm, 7"



CUSHING  
41058-18  
18 cm, 7"



scharf  
sharp  
agudo  
acuto

ADSON  
41068-20  
20 cm, 8"



stumpf  
blunt  
romo  
smusso

ADSON  
41069-20  
20 cm, 8"

Feine Wundhaken  
Retractors  
Separadores  
Divaricatori



spitz  
sharp  
agudo  
acuti

O'CONNOR  
43370-12  
12 cm, 4<sup>3</sup>/<sub>4</sub>"



spitz  
sharp  
agudo  
acuti

WIENER  
43372-13  
13 cm, 5<sup>1</sup>/<sub>8</sub>"



stumpf  
blunt  
romo  
smussi

WIENER  
43373-13  
13 cm, 5<sup>1</sup>/<sub>8</sub>"



spitz  
sharp  
agudo  
acuti

ROLLET  
43376-13  
13,5 cm, 5<sup>1</sup>/<sub>4</sub>"

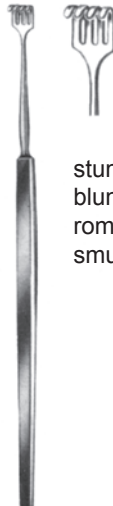

stumpf  
blunt  
romo  
smussi

KNAPP  
43377-13  
13 cm, 5<sup>1</sup>/<sub>8</sub>"

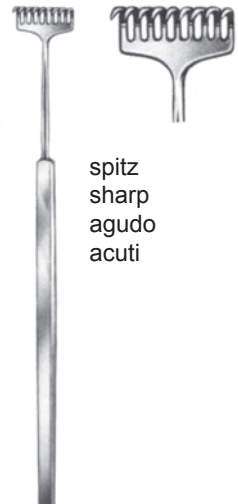

spitz  
sharp  
agudo  
acuti

MILLER  
43378-13  
13 cm, 5<sup>1</sup>/<sub>8</sub>"

Nasenhaken  
Nasal retractors  
Separadores nasales  
Retrattori nasali



CONVERSE

47538-01 9 cm, 3 1/2" 18 x 9,5 mm  
47538-02 9 cm, 3 1/2" 28 x 12,5 mm  
47538-03 9 cm, 3 1/2" 41 x 13,5 mm  
47538-04 9 cm, 3 1/2" 53 x 13,5 mm



COTTLE

47540-16  
16 cm, 6 1/4"



9 x 45 mm

MALINIAC

47550-11CL  
10 cm, 4"



9 x 45 mm

MALINIAC

47550-11  
10 cm, 4"

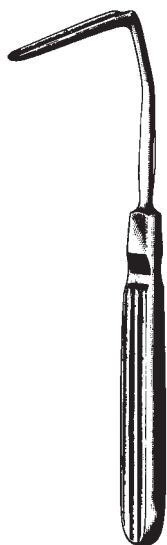

AUFRICHT

47551-16  
16 cm, 6 1/4"



AUFRICHT

47551-16CL  
16 cm, 6 1/4"



MASING-NEIVERT

47552-16  
16 cm, 6 1/4"

10 x 12 mm



COTTLE

47553-15  
15 cm, 6"

Hauthäkchen, Nasenhaken  
 Skin hook, Nasal retractors  
 Gancho para piel, Separadores nasales  
 Uncino per pelle, Retrattori nasali

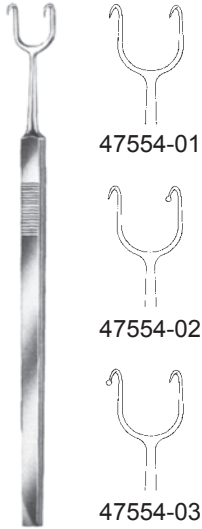

COTTLE  
 14,5 cm, 5<sup>3</sup>/<sub>4</sub>"

3 x 11 mm



KILNER  
 47555-08 8 cm, 3<sup>1</sup>/<sub>8</sub>"



FOMON  
 47556-16 16 cm, 6<sup>1</sup>/<sub>4</sub>"



FOMON  
 47557-17 17 cm, 6<sup>3</sup>/<sub>4</sub>"



FREER  
 47558-15 15 cm, 6"



COTTLE-NEIVERT  
 47559-20 20 cm, 8"



Feine Wundhaken  
 Retractors  
 Separadores  
 Divaricatori



Fig. 1  
 47560-18

Fig. 2  
 47562-18

GILLIES  
 18 cm, 7"



LANGE  
 47563-22 23 cm, 9"



COTTLE  
 47564-16 16 cm, 6 1/4"



CONVERSE  
 47566-12 12 cm, 4 3/4"

7,5 mm



MARTINEZ-KILNER  
 47567-11 11,5 cm, 4 1/2"

8 mm



COTTLE  
 47568-08

Trachealhaken  
Trachea Hooks  
Ganchos para traqueotomía  
Ganci per tracheotomia

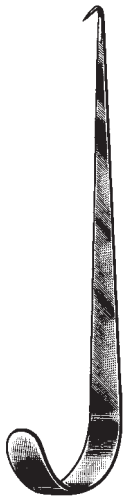

JACKSON  
55116-15  
15 cm, 6"



JACKSON  
55117-17  
17 cm, 6<sup>3</sup>/<sub>4</sub>"



NEWS  
55120-15  
15 cm, 6"

Nadelhalter  
Needle Holders  
Porta-agujas  
Portaghi



DERF  
25110-12 12 cm, 4<sup>3</sup>/<sub>4</sub>" 25114-12 TC



WEBSTER  
25128-13 13 cm, 5<sup>1</sup>/<sub>8</sub>"  
25129-13 TC 13 cm, 5<sup>1</sup>/<sub>8</sub>"



HALSEY  
25130-13 13 cm, 5<sup>1</sup>/<sub>8</sub>" 25140-13  
25134-13 TC 13 cm, 5<sup>1</sup>/<sub>8</sub>" 25144-13 TC

Nadelhalter  
 Needle Holders  
 Porta-agujas  
 Portaghi



**BAUMGARTNER**

- |          |                 |             |
|----------|-----------------|-------------|
| 25150-12 | 12,5 cm, 5"     | 25154-12 TC |
| 25150-14 | 14,0 cm, 5 1/2" | 25154-14 TC |



**CRILE-WOOD**

- |          |           |             |
|----------|-----------|-------------|
| 25160-15 | 15 cm, 6" | 25164-15 TC |
| 25160-18 | 18 cm, 7" | 25164-18 TC |
|          | 20 cm, 8" | 25164-20 TC |
|          | 23 cm, 9" | 25164-23 TC |



**MAYO-HEGAR**

- |          |               |             |
|----------|---------------|-------------|
| 25180-12 | 12 cm, 4 3/4" | 25184-12 TC |
| 25180-14 | 14 cm, 5 1/2" | 25184-14 TC |
| 25180-16 | 16 cm, 6 1/4" | 25184-16 TC |
| 25180-18 | 18 cm, 7"     | 25184-18 TC |
| 25180-20 | 20 cm, 8"     | 25184-20 TC |



**DeBAKEY**

- |             |               |
|-------------|---------------|
| 25214-16 TC | 16 cm, 6 1/4" |
| 25214-18 TC | 18 cm, 7"     |
| 25214-20 TC | 20 cm, 8"     |
| 25214-23 TC | 23 cm, 9"     |

Nadelhalter  
Needle Holder  
Porta-agujas  
Portaghi

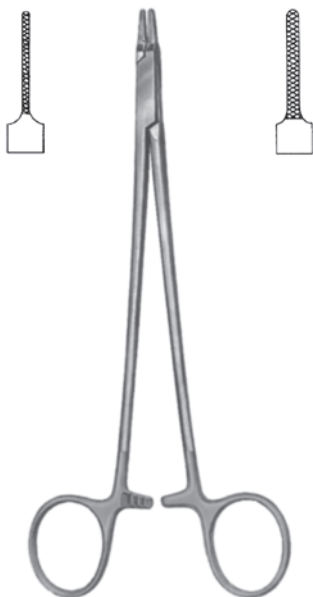

1 mm RYDER 2 mm

|            |  |             |
|------------|--|-------------|
| 25224-13TC | 13 cm, 5 <sup>1</sup> / <sub>8</sub> " | 25225-13 TC |
| 25224-15TC | 15 cm, 6"                              | 25225-15 TC |
| 25224-16TC | 16 cm, 6 <sup>1</sup> / <sub>4</sub> " | 25225-16 TC |
| 25224-18TC | 18 cm, 7"                              | 25225-18 TC |
| 25224-20TC | 20 cm, 8"                              | 25225-20 TC |



MICROVASCULAR

|            |           |
|------------|-----------|
| 25230-18TC | 18 cm, 7" |
| 25230-20TC | 20 cm, 8" |



BABY OLSEN-HEGAR

|            |  |            |
|------------|--|------------|
| 25405-12   | 12 cm, 4 <sup>3</sup> / <sub>4</sub> " | 25406-12   |
| 25408-12TC | 12 cm, 4 <sup>3</sup> / <sub>4</sub> " | 25407-12TC |

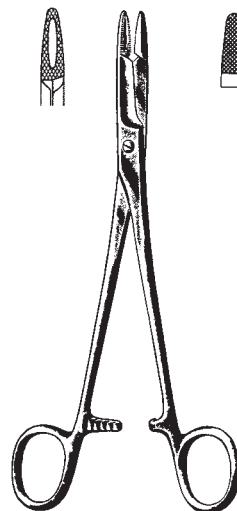

OLSEN-HEGAR

|          |  |            |
|----------|--|------------|
| 25410-14 | 14 cm, 5 <sup>1</sup> / <sub>2</sub> " | 25414-14TC |
| 25410-17 | 17 cm, 6 <sup>3</sup> / <sub>4</sub> " | 25414-17TC |
|          | 18 cm, 7"                              | 25414-18TC |

Nadelhalter  
Needle Holders  
Porta-agujas  
Portaghi



GILLIES

|            |  |
|------------|--|
| 25434-11TC | 11 cm, 4 <sup>3</sup> / <sub>8</sub> " |
| 25434-13TC | 13 cm, 5 <sup>1</sup> / <sub>8</sub> " |
| 25434-16TC | 16 cm, 6 <sup>1</sup> / <sub>4</sub> " |

Mikro-Nadelhalter  
 Micro Needle Holders  
 Micro-porta-agujas  
 Micro portaghi

ohne Sperre  
 without lock  
 sin cremallera  
 senza cremagliera

mit Sperre  
 with lock  
 con cremallera  
 con cremagliera



11,5 cm, 4 1/2"  
 13,0 cm, 5 1/8"  
 14,0 cm, 5 1/2"  
 18,0 cm, 7"  
 21,0 cm, 8 1/4"  
 23,0 cm, 9"

25660-12  
 25660-13  
 25660-14  
 25700-18

25661-12  
 25661-13  
 25661-14  
 25701-18

25720-12  
 25720-13  
 25720-14  
 25730-18  
 25730-21  
 25730-23

25731-12  
 25731-13  
 25731-14  
 25731-18  
 25731-21  
 25731-23

mit diamantiertem Maul  
 with diamond jaw  
 con boca de diamante  
 con morso diamantato

11,5 cm, 4 1/2"  
 13,0 cm, 5 1/8"  
 14,0 cm, 5 1/2"  
 18,0 cm, 7"  
 21,0 cm, 8 1/4"  
 23,0 cm, 9"

25720-12D  
 25720-13D  
 25720-14D  
 25730-18D  
 25730-21D  
 25730-23D

25671-12D  
 25671-13D  
 25671-14D  
 25731-18D  
 25731-21D  
 25731-23D

T= Titan, titanium, titanio, titanio



15,0 cm, 6"  
 18,0 cm, 7"  
 21,0 cm, 8 1/4"

|           |           |           |           |
|-----------|-----------|-----------|-----------|
| 93250-15T | 93251-15T | 93260-15T | 93261-15T |
| 93250-18T | 93251-18T | 93260-18T | 93261-18T |
| 93250-21T | 93251-21T | 93260-21T | 93261-21T |



BARRAQUER

Mikro-Nadelhalter mit Sperre  
 Micro Needle Holders, with lock  
 Micro-porta-agujas con cremallera  
 Micro portaghi, con cremagliera



14,0 cm, 5 1/2"  
 18,0 cm, 7"  
 21,5 cm, 8 1/2"  
 23,0 cm, 9"



25670-14  
 25670-18  
 25670-21



25671-14  
 25671-18



25672-14  
 25672-18  
 25672-21  
 25672-23



25673-14  
 25673-18

mit TC 1,4 mm  
 with TC jaw 1,4 mm  
 con TC 1,4 mm  
 con morso in TC 1,4 mm

14,0 cm, 5 1/2"  
 18,0 cm, 7"  
 21,5 cm, 8 1/2"  
 23,0 cm, 9"

|          |          |          |          |
|----------|----------|----------|----------|
| 25674-14 | 25675-14 | 25676-14 | 25677-14 |
| 25674-18 | 25675-18 | 25668-18 | 25691-18 |
| 25674-21 |          | 25668-21 |          |
|          |          | 25668-23 |          |

mit diamantiertem Maul 0,8 mm  
 with diamond jaw 0,8 mm  
 con boca de diamante 0,8 mm  
 con morso diamantato 0,8 mm

14,0 cm, 5 1/2"  
 18,0 cm, 7"  
 21,5 cm, 8 1/2"  
 23,0 cm, 9"

|           |           |
|-----------|-----------|
| 25672-14D | 25673-14D |
| 25672-18D | 25673-18D |
| 25672-21D |           |
| 25672-23D |           |

T= Titan, titanium, titanio, titanio  
 Maul/jaw/boca/morso 0,4mm

14,0 cm, 5 1/2"  
 18,0 cm, 7"  
 21,5 cm, 8 1/2"

|           |           |
|-----------|-----------|
| 25672-14T | 25673-14T |
| 25672-18T | 25673-18T |
| 25672-21T | 25673-21T |

CASTROVIEJO



Drahtzangen  
Wire Twisting Forceps  
Pinza para torcer hilos  
Pinza torcifili



MAYO-HABERISSER



34554-15 TC 15 cm, 6" 34555-15 TC



34554-18 TC 18 cm, 7" 34555-18 TC



34554-20 TC 20 cm, 8" 34555-20 TC



BERRY

34556-18TC 18 cm, 7"

Hohlmeißelzange  
 Bone Rongeurs  
 Pinzas-gubias  
 Pinze sgorbie

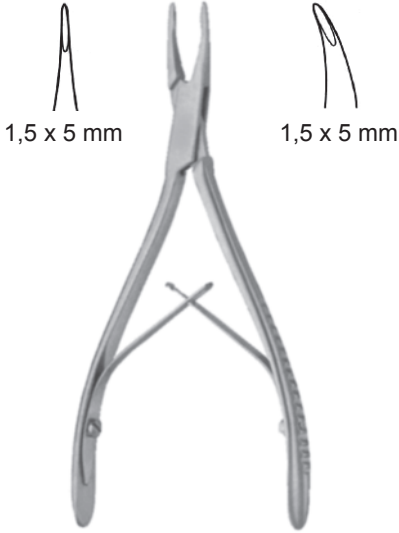

**MICRO FRIEDMANN**  
 33100-01 14,5 cm, 5<sup>3</sup>/<sub>4</sub>" 33100-02



**FRIEDMANN MINI**  
 33101-12 12 cm, 4<sup>3</sup>/<sub>4</sub>"



**FRIEDMANN**  
 33101-14 14 cm, 5<sup>1</sup>/<sub>2</sub>"



**BEYER**  
 33201-18 18 cm, 7"

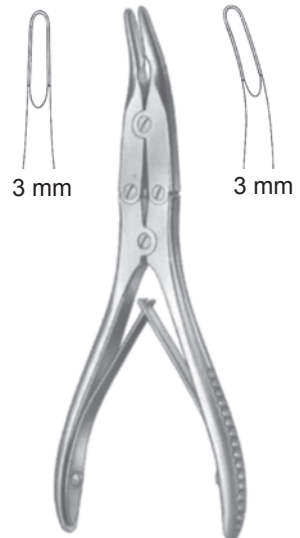

**BÖHLER**  
 33211-15 15 cm, 6" 33213-15

Knochensplitterzangen  
Bone Cutting Forceps  
Pinzas cortantes para huesos  
Cesoie per ossa



BÖHLER  
33280-15 15 cm, 6"



BÖHLER  
33281-15 15 cm, 6"



COTTLE-KAZANJIAN  
33282-19 19 cm, 7 1/2"



MC INDOE  
33283-17 17 cm, 6 3/4"

Hämmer  
Bone Mallets  
Martillos  
Martelli

Ø 25 mm



GERZOG  
33686-25  
18 cm, 7" 250g

Ø 25 mm



33694-01 18,5 cm, 7<sup>1</sup>/<sub>4</sub>", 135 g  
33694-03 Ersatzbacken  
Nylon Caps  
Tapas de repuesto  
Placche di ricambio

Ø 25 mm



33694-02 18,5 cm, 7<sup>1</sup>/<sub>4</sub>"  
mit Nylonbacke  
with nylon tap  
con tapa de nylon  
con placca di nylon

Ø 20 mm



MEAD  
33693-32  
17 cm, 6<sup>3</sup>/<sub>4</sub>" 320 g

Ø 22 mm



PARTSCH  
33698-98  
18 cm, 7" 199 g



QUISLING  
33696-75  
17 cm, 6<sup>3</sup>/<sub>4</sub>"

Ø 30 mm



COTTLE  
33700-05  
18 cm, 7" 240 g

Elevatoren, Raspatoren  
Elevators, Raspatories  
Elevadores, Legras  
Elevatori, Periostotomi



LANGENBECK  
20 cm, 8"  
33711-20 8 mm  
33711-21 10 mm



4 mm

WILLIGER  
16 cm, 6 1/4"  
33711-16



6,5 mm

WILLIGER  
16 cm, 6 1/4"  
33712-16



5,5 mm

WILLIGER  
33713-17  
16 cm, 6 1/4"



4 mm

JOSEPH  
33718-16  
16 cm, 6 1/4"



4 mm

FOMON  
33719-17  
16 cm, 6 1/4"

Elevatoren, Raspatoren  
Elevators, Raspatories  
Elevadores, Legras  
Elevatori, Periostotomi

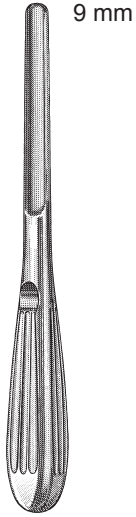

**BOIES**  
33720-19  
19 cm, 7 1/2"



**GORNEY**  
33720-21  
21 cm, 8 1/4"

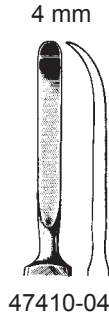

47410-04

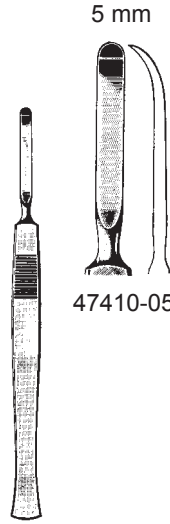

47410-05

**McKENY**  
15 cm, 6"



**JOSEPH**  
47411-16  
16 cm, 6 1/4"



**MASIG**  
47414-21  
22 cm, 8 3/4"

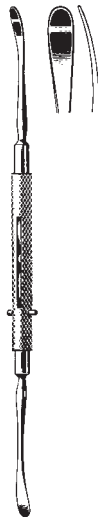

**FREER**  
47415-18  
18 cm, 7"

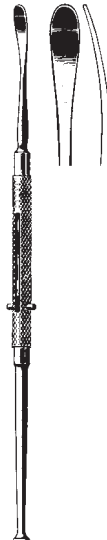

**FREER**  
47417-19  
19 cm, 7 1/2"

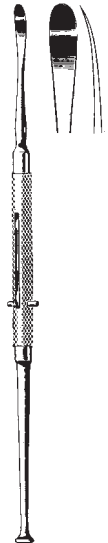

**FREER**  
47419-19  
19 cm, 7 1/2"

Elevatoren, Raspatoren  
Elevators, Raspatories  
Elevadores, Legras  
Elevatori, Periostotomi



KILLIAN  
47420-01  
18,5 cm, 7<sup>1</sup>/<sub>4</sub>"



PIERCE  
47420-02  
21 cm, 8<sup>1</sup>/<sub>4</sub>"



SINUS  
47420-03  
18 cm, 7"



PENNINGTON  
47420-04  
21 cm, 8<sup>1</sup>/<sub>4</sub>"



McKENTY  
47420-20  
22 cm, 8<sup>3</sup>/<sub>4</sub>"

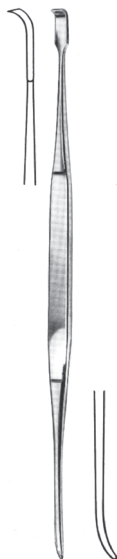

HOWARTH  
47421-21  
21,5 cm, 8<sup>1</sup>/<sub>2</sub>"



COTTLE  
47421-23  
23 cm, 9"



COTTLE JOSEPH  
47422-22  
22 cm, 8<sup>3</sup>/<sub>4</sub>"

Elevatoren, Raspatoren  
 Elevators, Raspatories  
 Elevadores, Legras  
 Elevatori, Periostotomi



COTTLE  
 47423-22 22 cm, 8<sup>3</sup>/<sub>4</sub>"

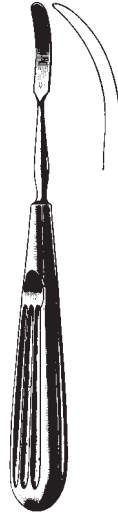

COTTLE  
 47424-16 16 cm, 6<sup>1</sup>/<sub>4</sub>"



COTTLE  
 47425-19 19 cm, 7<sup>1</sup>/<sub>2</sub>"



KILLIAN  
 47426-22 22 cm, 8<sup>3</sup>/<sub>4</sub>"



HAJEK-BALLENGER  
 47428-21 22 cm, 8<sup>3</sup>/<sub>4</sub>"



BALLENGER  
 47430-22 22 cm, 8<sup>3</sup>/<sub>4</sub>"



Lippen- und Gaumenspaltinstrumente  
Lip and Cleft Palate Instruments  
Instrumentos para labios y fisura palatina  
Strumenti per labbra e fessure del palato



49278-01 14 cm, 5 1/2" 49278-02



graduirt  
graduated  
graduado  
graduato

CRONIN  
49280-18 18 cm, 7"

Lippen- und Gaumenspaltinstrumente  
Lip and Cleft Palate Instruments  
Instrumentos para labios y fisura palatina  
Strumenti per labbra e fessure del palato



BLAIR  
49281-01  
23 cm , 9"



BLAIR  
49281-02  
20 cm, 8"

Saugkanülen  
Suction Tubes  
Tubos de aspiracion  
Cannula aspirante



ADSON  
41290-21  
20 cm, 8<sup>1</sup>/<sub>4</sub>"  
Ø 4 mm



Arbeitslänge  
working length  
largo útil  
lunghezza utile  
75 mm

BARON  
41299-03 3FR Ø 1,0 mm  
41299-05 5FR Ø 1,6 mm  
41299-07 7FR Ø 2,3 mm

Saugkanülen  
Suction Tubes  
Tubos de aspiracion  
Cannula aspirante



FRAZIER/FERGUSON  
19 cm, 7 1/2"

Charr.

| F.G. | Ø      | 30°      | 75°      |
|------|--------|----------|----------|
| 6    | 2,0 mm | 41295-06 | 41297-06 |
| 7    | 2,3 mm | 41295-07 | 41297-07 |
| 8    | 2,7 mm | 41295-08 | 41297-08 |
| 9    | 3,0 mm | 41295-09 | 41297-09 |
| 10   | 3,3 mm | 41295-10 | 41297-10 |
| 11   | 3,6 mm | 41295-11 | 41297-11 |
| 12   | 4,0 mm | 41295-12 | 41297-12 |

Saugkanülen  
Suction Tubes  
Tubos de aspiracion  
Cannula aspirante

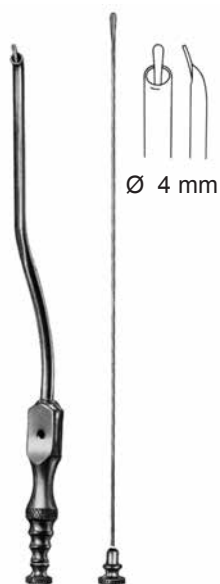

GULEN  
47347-20  
19 cm, 7 1/2"  
Ø 4 mm

Nasenspekula  
Nasal Speculum  
Espéculos nasales  
Specoli nasali



HARTMANN-HALLE  
15 cm, 6"

28 mm



47102-01  
Fig. 1

30 mm

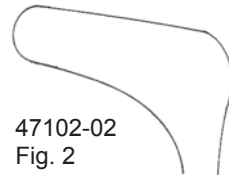

47102-02  
Fig. 2

32 mm

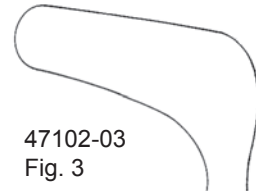

47102-03  
Fig. 3

Nasenspekula  
Nasal Speculum  
Espéculos nasales  
Specoli nasali



HARTMANN  
16 cm, 6 1/4"

30 mm

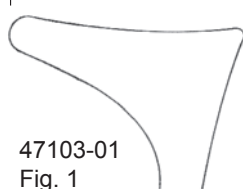

47103-01  
Fig. 1

33 mm

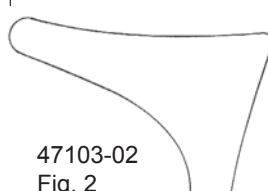

47103-02  
Fig. 2

35 mm



47103-03  
Fig. 3

Nasenspekula  
 Nasal Speculum  
 Espéculos nasales  
 Specoli nasali



Mod. WIEN  
 14 cm, 5 1/2"

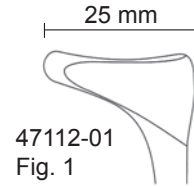

Baby, bebé, neonato

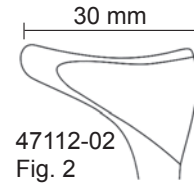

Kind, child, niño, bambino

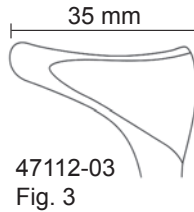

Erwachsene, Adult, adulto



TIECK-HALLE  
 47116-13  
 13,5 cm, 5 1/4"



REDA  
 47118-13  
 12,5 cm, 5"



Nasenspekula  
Nasal Specula  
Espéculos nasales  
Specoli nasali

35 mm

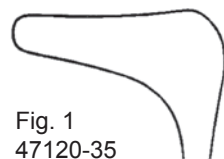

Fig. 1  
47120-35  
47120-35CL

50 mm



Fig. 2  
47120-50  
47120-50CL

75 mm

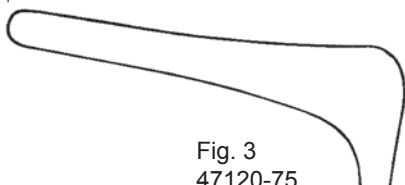

Fig. 3  
47120-75  
47120-75CL

90 mm

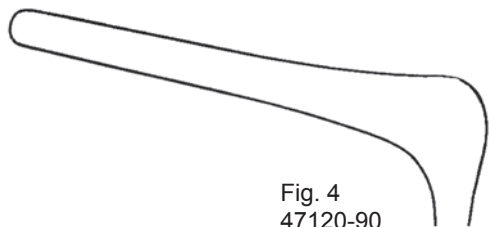

Fig. 4  
47120-90  
47120-90CL

CL = mit Kaltlicht  
with cold light  
con luz fria  
con luce fredda



KILLIAN  
13 cm, 5 1/8"

Nasenspekula  
Nasal Specula  
Espéculos nasales  
Specoli nasali



KILLIAN  
13 cm, 5<sup>1</sup>/<sub>8</sub>"

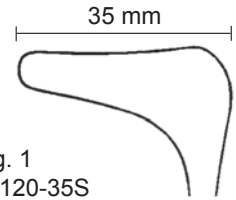

Fig. 1  
47120-35S

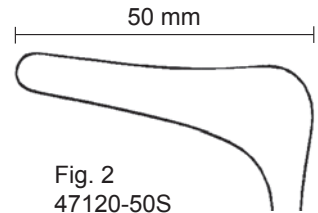

Fig. 2  
47120-50S

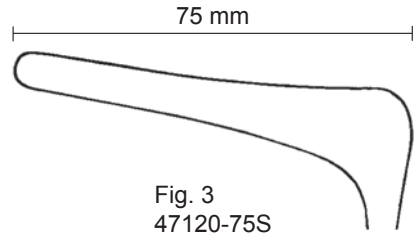

Fig. 3  
47120-75S

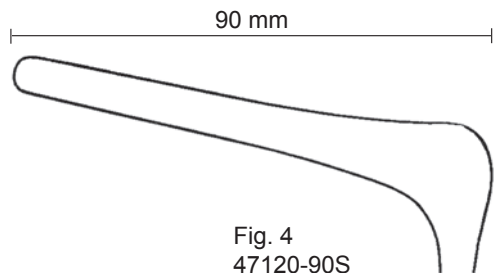

Fig. 4  
47120-90S

Nasenspekula  
Nasal Speculum  
Espéculos nasales  
Specoli nasali

35 mm

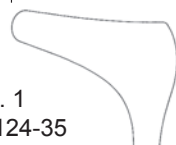

Fig. 1  
47124-35  
47124-35CL

50 mm

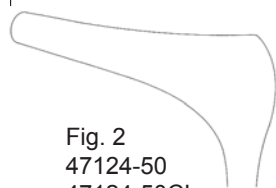

Fig. 2  
47124-50  
47124-50CL

75 mm

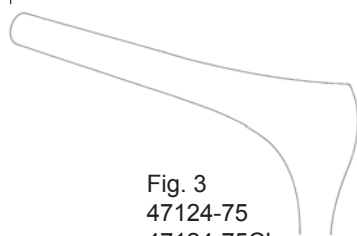

Fig. 3  
47124-75  
47124-75CL

90 mm

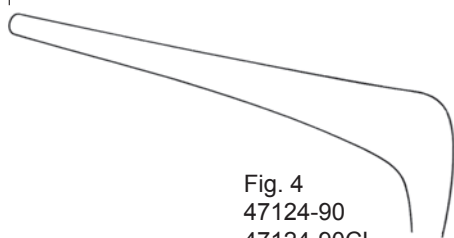

Fig. 4  
47124-90  
47124-90CL

CL = mit Kaltlicht  
with cold light  
con luz fria  
con luce fredda



**COTTLE**  
14 cm, 5 1/2"

Nasenspekula  
Nasal Speculum  
Espéculos nasales  
Specoli nasali



**COTTLE**  
14 cm, 5 1/2"

35 mm

Fig. 1  
47124-35S

50 mm

Fig. 2  
47124-50S

75 mm

Fig. 3  
47124-75S

90 mm

Fig. 4  
47124-90S

Nasentamponzange, Polypenzange  
Nasal Tampon Forceps, Ear Polypus Forceps  
Pinza para taponamiento, Pinzas para pólipos  
Pinze per medicature, Pinze per polipi

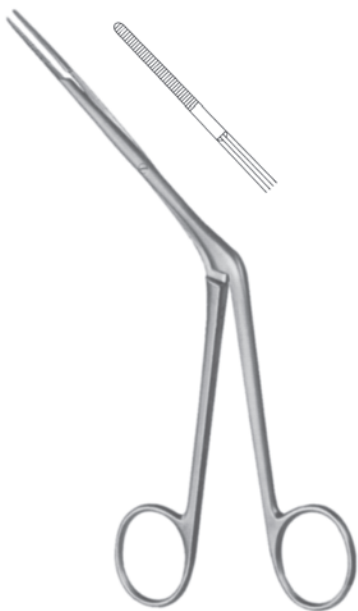

WESTMACOTT  
47158-20 20 cm, 8"



LUBET-BARBON  
47159-20 20 cm, 8"



HARTMANN  
47161-16 16 cm, 6 1/4"



HARTMANN  
47161-20 20 cm, 8"

Polypenzangen, Septumzangen  
Nasal Polypus and Septum Forceps  
Pinzas para pólipos y para el tabique nasal  
Pinze per polipi, Pinze per il setto nasale



HEYMANN-KNIGHT  
47169-18  
18 cm, 7"



KNIGHT  
47185-18  
18 cm, 7"

Septumzangen  
 Septum Forceps  
 Pinzas para el tabique nasal  
 Pinze per il setto nasale

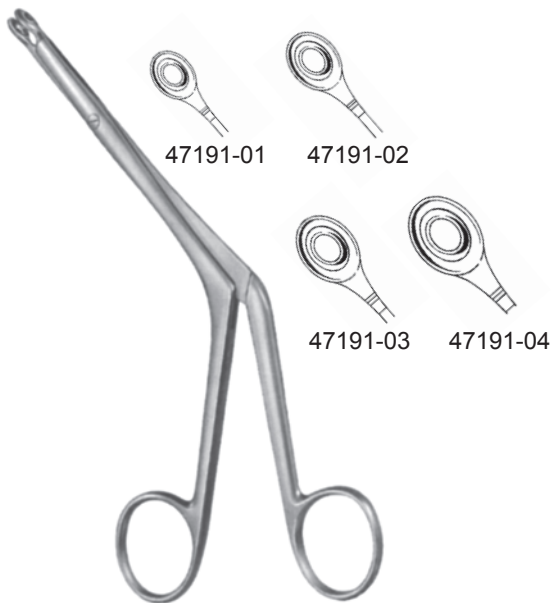

**BRUENINGS**  
 19 cm, 7 1/2"

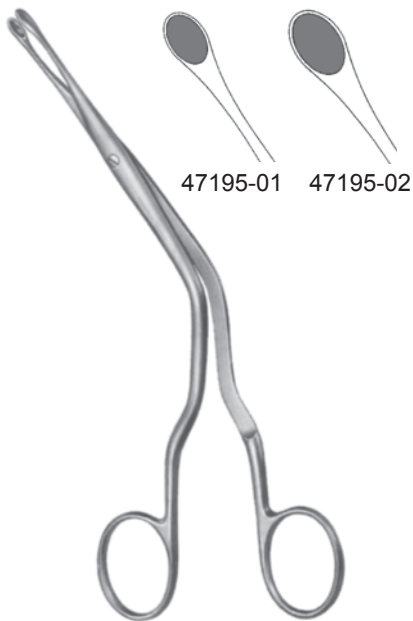

**LUC**  
 19 cm, 7 1/2"





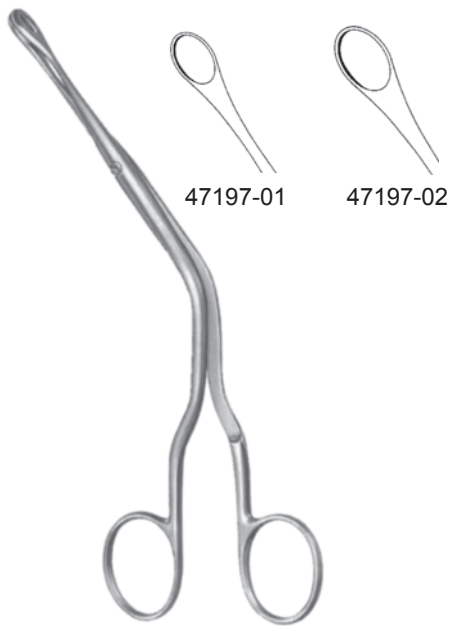



**CRAIG**  
 47192-16 18 cm, 7"

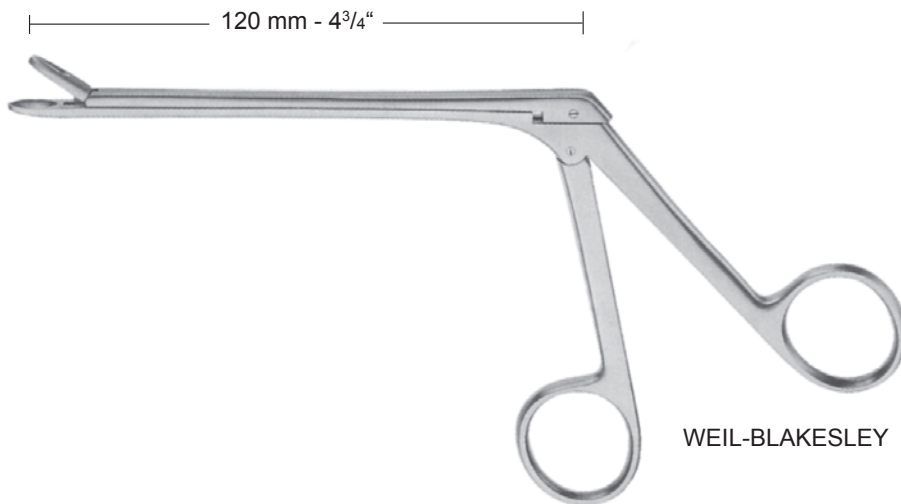

**LUC**  
 19 cm, 7 1/2"

Scharfe Nasenzange  
 Nasal Cutting Forceps  
 Pinzas cortantes nasales  
 Pinze taglianti nasali



|  | Fig.1              | Fig. 2             | Fig.3              | Fig.4  | Fig. 5             |
|--|--------------------|--------------------|--------------------|--|--------------------|
|  | 47223-01<br>3,0 mm | 47223-02<br>3,6 mm | 47223-03<br>4,2 mm | 47223-04<br>4,8 mm   | 47223-05<br>5,8 mm |
|  | 47224-01<br>3,0 mm | 47224-02<br>3,6 mm | 47224-03<br>4,2 mm | 47224-04<br>4,8 mm   | 47224-05<br>5,8 mm |
|  | 47225-01<br>3,0 mm | 47225-02<br>3,6 mm | 47225-03<br>4,2 mm | 47225-04<br>4,8 mm   |                    |
|  | 47226-01<br>2,0 mm | 47226-02<br>2,5 mm | 47226-03<br>3,0 mm | durchschneidend<br>through cutting<br>cortantes<br>taglianti |                    |
|  | 47227-01<br>2,0 mm | 47227-02<br>2,5 mm | 47227-03<br>3,0 mm |  |                    |



Scharfe Nasenzangen  
Nasal Cutting Forceps  
Pinzas cortantes nasales  
Pinze taglianti nasali

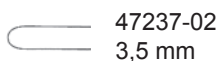
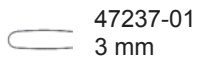

47239-01

47239-02



MYLES



SCHMEDEN



TAKAHASHI



47242-00



47242-01

Septumzange, Nasenscheren  
Septum Forcep, Nasal Cutting Scissors  
Pinza para el tabique nasal, Tijeras nasales  
Pinza per setto nasale, Forbici nasali



RUBIN  
47251-21  
21 cm, 8<sup>1</sup>/<sub>4</sub>"



CAPLAN  
47256-20  
20 cm, 8"



GORNEY  
49257-20 TC  
20 cm, 8"

Septumzangen  
Septum Forceps  
Pinzas para el tabique nasal  
Pinze per il setto nasale



MIDDLETON-JANSEN  
47323-19  
19 cm, 7 $\frac{1}{2}$ "



MIDDLETON-JANSEN  
47325-19  
19 cm, 7 $\frac{1}{2}$ "

Rhinoplastikmesser  
 Rhinoplasty knives  
 Cuchillos nasales  
 bisturi nasale



JOSEPH  
 16 cm, 6<sup>1</sup>/<sub>4</sub>"



47370-16 stumpf, blunt,  
 romo, smussi



47372-16 spitz, pointed,  
 agudo, acuti



FREER  
 47374 - 16  
 16,5 cm, 6<sup>1</sup>/<sub>2</sub>"



JOSEPH  
 47375 - 16  
 16 cm, 6<sup>1</sup>/<sub>4</sub>"

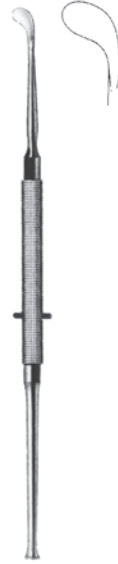

FREER  
 47375 - 19  
 19 cm, 7<sup>1</sup>/<sub>2</sub>"

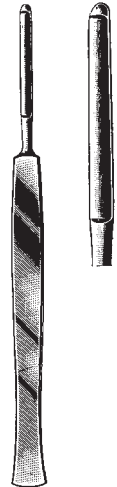

JOSEPH  
 47376 - 16  
 16 cm, 6<sup>1</sup>/<sub>4</sub>"

Rhinoplastikmesser  
 Rhinoplasty knives  
 Cuchillos nasales  
 bisturi nasale

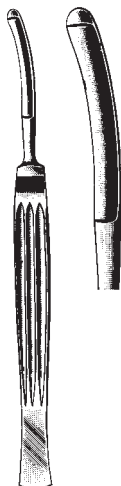

CONVERSE  
 47379 - 16  
 16 cm, 6 1/4"



COTTLE  
 47380-15  
 15 cm, 6"



COTTLE  
 47382-15  
 15 cm, 6"



JOSEPH  
 47384-15  
 15 cm, 6"



JOSEPH  
 47385-15  
 15 cm, 6"



REDA  
 19 cm 7 1/2"



47386-01  
 spitz  
 pointed  
 agudo  
 acuto



47386-02  
 stumpf  
 blunt  
 romo  
 smusso

Schwingmesser  
Septum Swivel Knives  
Cuchillos para el tabique nasal  
Coltelli per setto



**BALLENGER**  
47390-03 - 47392-05  
20 cm, 8"



47390-03  
3 mm



47390-04  
4 mm



47390-05  
5 mm



47392-03  
3 mm



47392-04  
4 mm



47392-05  
5 mm

Osteotome, Septum Meißel  
 Osteotomes, Rhinoplastic Chisels  
 Osteotomo, Cinceles para la plástica nasal  
 Osteotomi, Scalpelli per plastica nasale

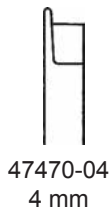

47470-04  
4 mm

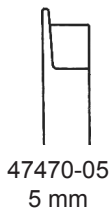

47470-05  
5 mm



47470-06  
6 mm

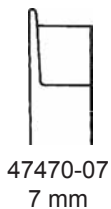

47470-07  
7 mm

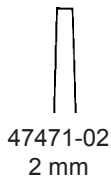

47471-02  
2 mm

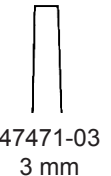

47471-03  
3 mm

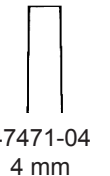

47471-04  
4 mm

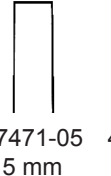

47471-05  
5 mm



47471-06  
6 mm

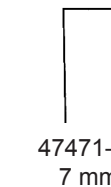

47471-07  
7 mm

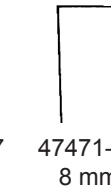

47471-08  
8 mm

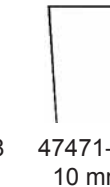

47471-10  
10 mm

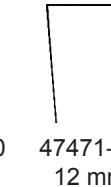

47471-12  
12 mm

FOMON  
47470-04 - 47470-07  
17 cm, 6<sup>3</sup>/<sub>4</sub>"

SHEEHAN  
47471-07 - 47471-12  
16 cm, 6<sup>1</sup>/<sub>4</sub>"

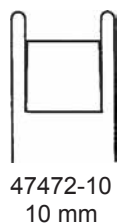

47472-10  
10 mm

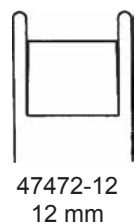

47472-12  
12 mm

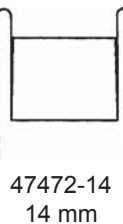

47472-14  
14 mm



47472-16  
16 mm

CINELLI  
47472-10 - 47472-16  
16 cm, 6<sup>1</sup>/<sub>4</sub>"

Septum Meißel  
Rhinoplastic Chisels  
Cinceles para la plástica nasal  
Scalpelli per plastica nasale

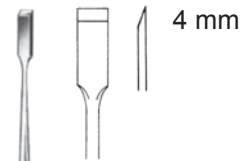

FREER  
47450-04  
15 cm, 6"

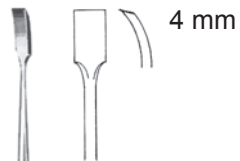

FREER  
47451-04  
15 cm, 6"



Septum Meißel, Osteotome  
 Rhinoplastic Chisels, Osteotomes  
 Cinceles para la plástica nasal, Osteotomos  
 Scalpelli per plastica nasale, Osteotomi



COTTLE  
18 cm, 7"



COTTLE  
47455-06  
18 cm, 7"

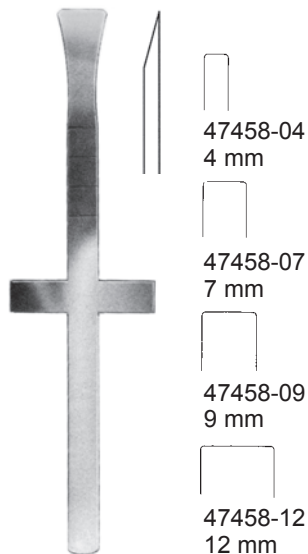

COTTLE  
18 cm, 7"

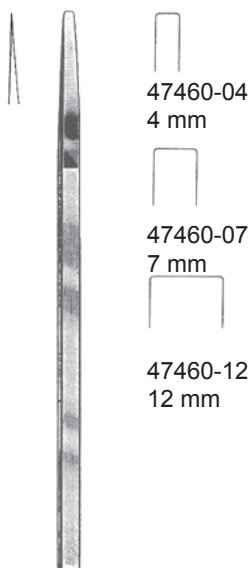

COTTLE  
18 cm, 7"

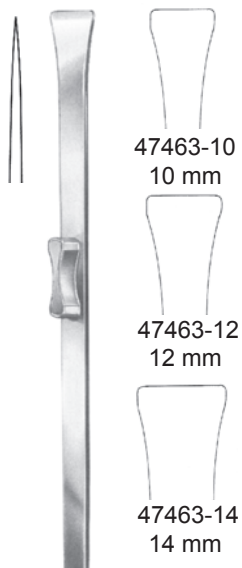

RUBIN  
18,5 cm, 7 1/4"

Osteotome, Septum Meißel  
 Osteotomes, Rhinoplastic Chisels  
 Osteotomo, Cinceles para la plástica nasal  
 Osteotomi, Scalpelli per plastica nasale

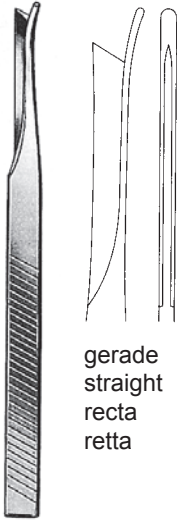

gerade  
 straight  
 recta  
 retta

SILVER  
 47473-01  
 18 cm, 7"

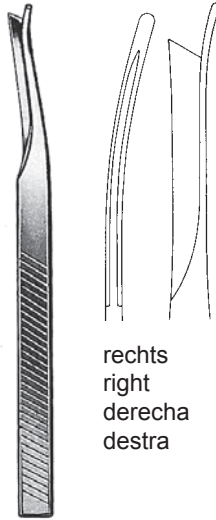

rechts  
 right  
 derecha  
 destra

SILVER  
 47473-02  
 18 cm, 7"

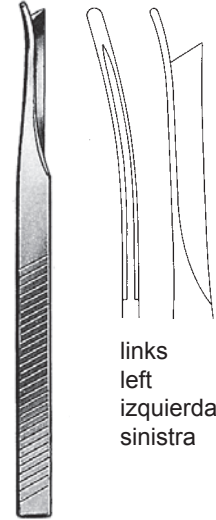

links  
 left  
 izquierda  
 sinistra

SILVER  
 47473-03  
 18 cm, 7"

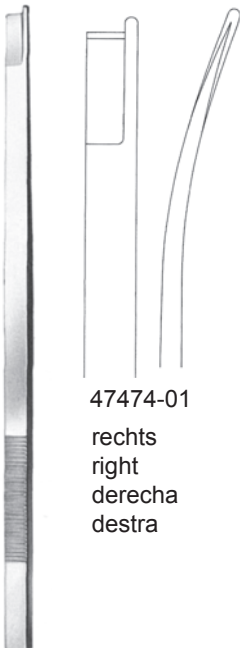

47474-01  
 rechts  
 right  
 derecha  
 destra

NEIVERT-ANDERSON  
 20,5 cm, 8" 7 mm



47474-02  
 links  
 left  
 izquierda  
 sinistra



47474-03  
 gerade  
 straight  
 recta  
 retta



KILLIAN  
 47481-05 16 cm, 6 1/4"

Osteotome  
Osteotomes  
Osteotomo  
Osteotomi

|          |      |
|----------|------|
| 47475-04 | 4 mm |
| 47475-06 | 6 mm |
| 47475-08 | 8 mm |



OBWEGESER  
18,5 cm, 7<sup>1</sup>/<sub>4</sub>"

Septum Meißel, Osteotome, Hohlmeißel  
 Rhinoplastic Chisels, Osteotomes, Gouges  
 Cinceles para la plástica nasal, Osteotomos, Gubias  
 Scalpelli per plastica nasale, Osteotomi, Sgorbie



KILLIAN-CLAUS  
 47482-05  
 17 cm, 6<sup>3</sup>/<sub>4</sub>"



HAJEK  
 47484-04 4 mm  
 47484-06 6 mm  
 47484-08 8 mm  
 16 cm, 6<sup>1</sup>/<sub>4</sub>"



WEST  
 47486-16  
 16 cm, 6<sup>1</sup>/<sub>4</sub>"



WEST  
 47487-16  
 16 cm, 6<sup>1</sup>/<sub>4</sub>"

6 mm



FREER  
 47489-16  
 16 cm, 6<sup>1</sup>/<sub>4</sub>"



2 mm



3 mm



4 mm



5 mm



6 mm



8 mm



10 mm



12 mm



15 mm

12,5 cm, 5"

33654-02

33654-03

33654-04

33654-05

33654-06

33654-08

33654-10

33654-12

33654-15

mm

2

3

4

5

6

8

10

12

15

17 cm, 6<sup>3</sup>/<sub>4</sub>"

33652-02

33652-03

33652-04

33652-05

33652-06

33652-08

33652-10

33652-12

33652-15

MINI-LAMBOTTE

Knorpelquetscher  
Cartilage crusher  
Macha cadera  
Tritacartilagine



COTTLE  
47461-00 7,5 cm, 3"

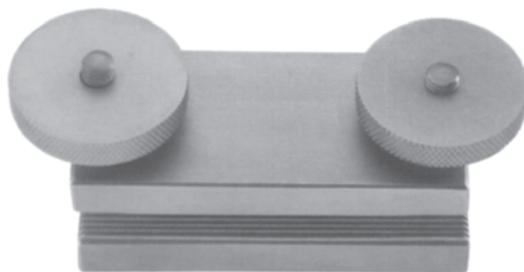

JOST  
47462-00

Nasenraspeln  
 Nasal Rasps  
 Escofinas nasales  
 Raspa nasale



JOSEPH  
 47502-16 16 cm, 6 1/4"



MALTZ  
 47504-18 18 cm, 7"

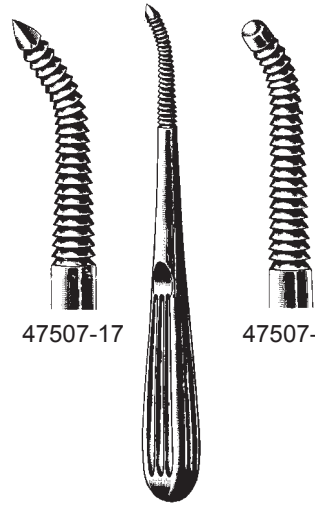

47507-17

47507-18

WIENER  
 18 cm, 7"



diamantiert  
 with diamond coating  
 con boca de diamante  
 diamantata

PEET  
 47523-01 19 cm 7 1/2" 47523-02



GLABELLA  
 47524-01 21 cm, 8 1/4"



47525-20  
 fein, fine, fino, fina  
 20 Zähne  
 20 teeth  
 20 dientes  
 20 denti

47526-20  
 grob, coarse, gruesa, grossa  
 11 Zähne  
 11 teeth  
 11 dientes  
 11 denti

PARKES  
 47525-20 21 cm, 8 1/4"

Nasenraspeln  
 Nasal Rasps  
 Escofinas nasales  
 Raspa nasale

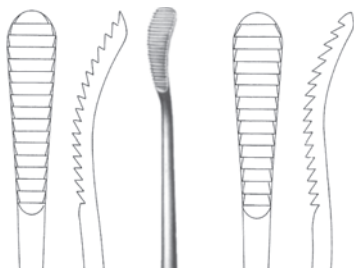

AUFRICHT  
 47511-21 21 cm, 8<sup>1</sup>/<sub>4</sub>" 47513-21



JOSEPH (LEWIS)  
 47514-16 18 cm, 7" 47516-16



MALTZ (COTTLE)  
 47518-21 21 cm, 8<sup>1</sup>/<sub>4</sub>"



47505-18 TC



47506-18 TC

MALTZ  
 17,5 cm, 6.9"

Nasenraspeln  
Nasal Rasps  
Escofinas nasales  
Raspa nasale

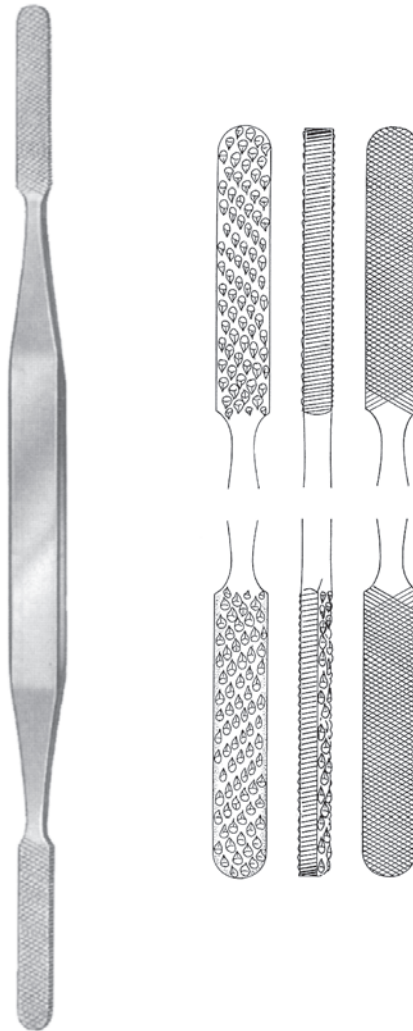

FOMON  
47520-21  
21 cm, 8<sup>1</sup>/<sub>4</sub>"



Nasenraspeln  
 Nasal Rasps  
 Escofinas nasales  
 Raspa nasale

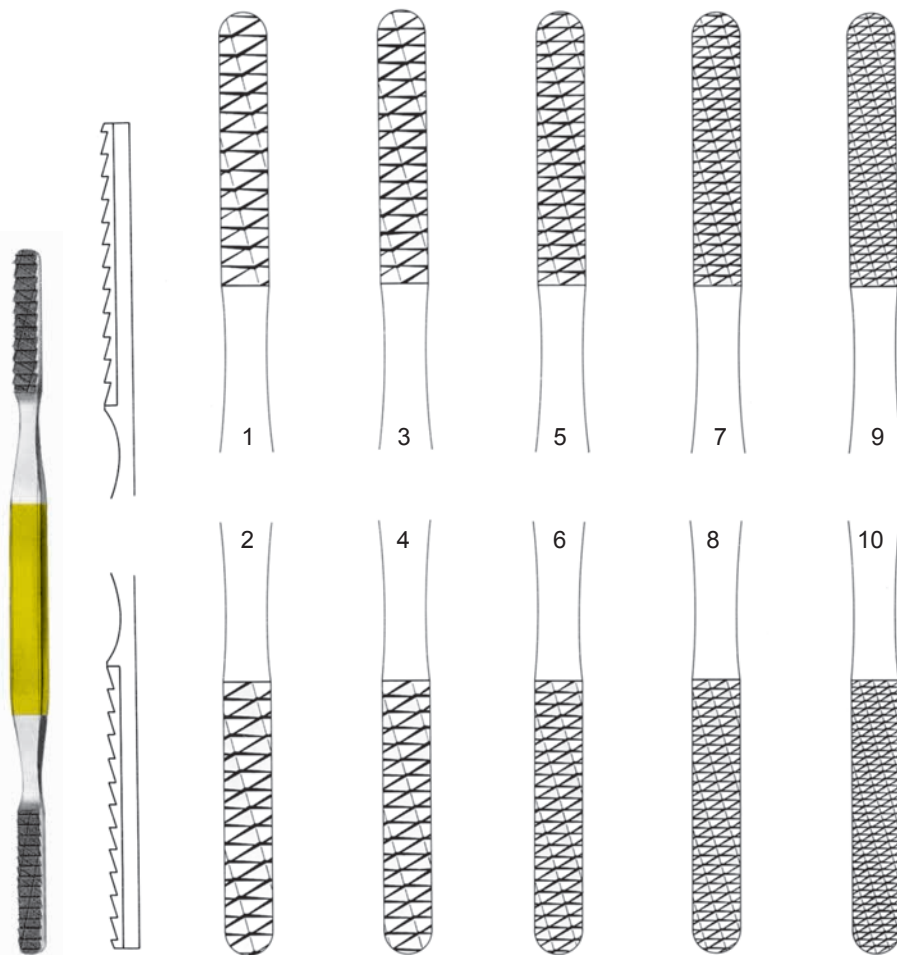

FOMON

47522-01TC - 47522-09 TC

20 cm, 8"

Fig. 1/2

47522-01 TC

Fig. 3/4

47522-04 TC

Fig. 5/6

47522-05 TC

Fig. 7/8

47522-07 TC

Fig. 9/10

47522-09 TC

Nasenraspeln, Nasensägen  
 Nasal Rasps, Nasal Saws  
 Escofinas nasales, Sierras nasales  
 Raspa nasale, Seghe nasale

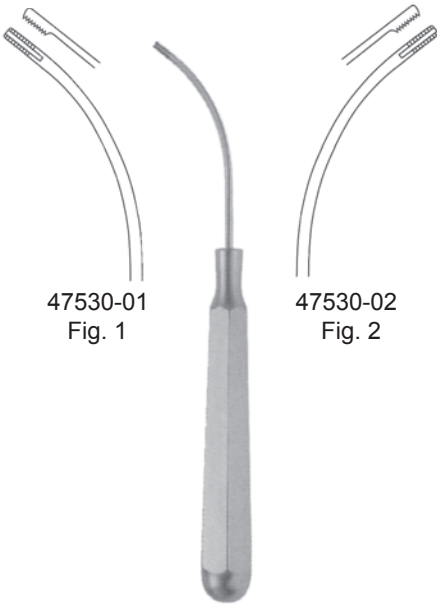

47530-01  
Fig. 1

47530-02  
Fig. 2

DINGMAN Set  
47530-00 15 cm, 6"

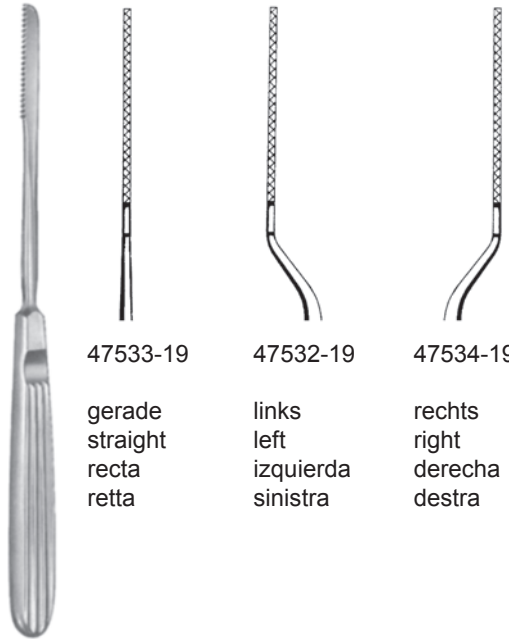

47533-19  
gerade  
straight  
recta  
retta

47532-19  
links  
left  
izquierda  
sinistra

47534-19  
rechts  
right  
derecha  
destra

JOSEPH  
19 cm, 7 1/2"

Nasensägen  
Nasal Saws  
Sierras nasales  
Seghe nasale



JOSEPH  
47535-01 17 cm, 6<sup>3</sup>/<sub>4</sub>" 47535- 02

Septumrichtzangen  
Septum Straightening Forceps  
Pinza para enderezar el tabique nasal  
Pinza per la plastica nasale



ASCH  
47571-23  
23 cm, 9"



WALSHAM  
47572-23  
23 cm, 9"

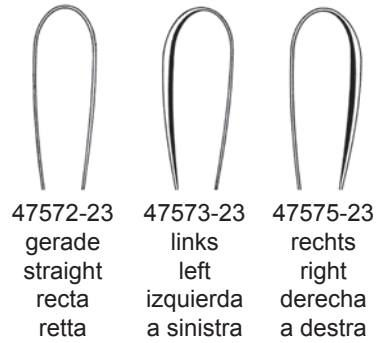

Zungendrucker, Mundsperrer  
 Tongue Depressors, Mouth Gags  
 Boja-lengua, Abre-Bocas  
 Abbassalingua, Apribocca



CL = mit Kaltlicht  
 with cold light  
 con luz fria  
 con luce fredda

WIEDER



49115-01  
 49115-01CL  
 Fig. 1  
 14 cm, 5 1/2"



49115-02  
 49115-02CL  
 Fig. 2  
 15 cm, 6"

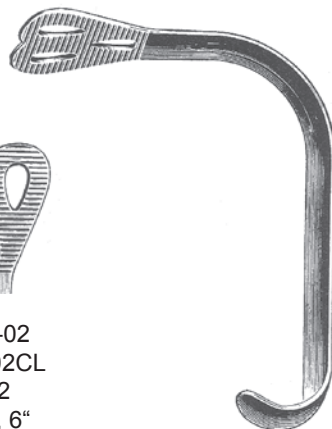

WIEDER



ANDREW  
 49117-11  
 11 cm, 4 3/8"

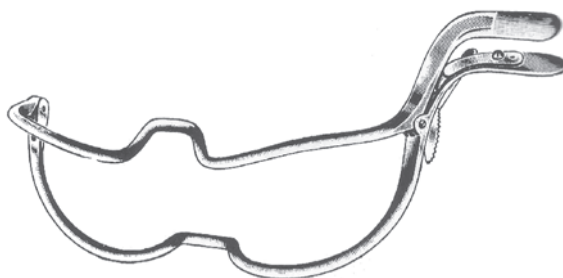

JENNINGS  
 49274-09 9 cm, 3 1/2"  
 49274-11 11 cm, 4 3/8"  
 49274-13 13 cm, 5 1/8"  
 49274-15 15 cm, 6"

Mundsperrer  
 Mouth Gags  
 Abre-Bocas  
 Apribocca

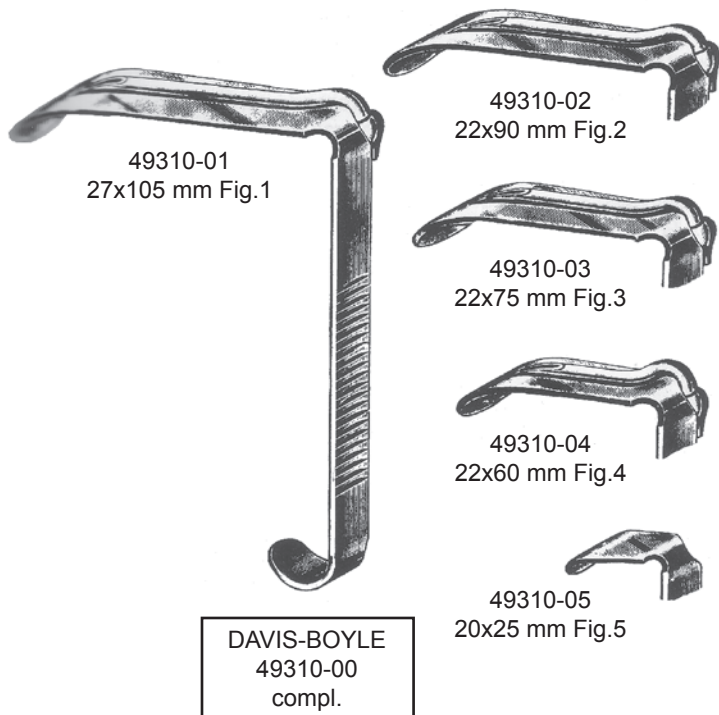

Sperrer allein  
 Gag only  
 Abre-boca suelto  
 Apribocca solo

DAVIS-BOYLE

|  |  |   |
|--|--|---|
|  | für Erwachsene<br>for adults<br>para adultos<br>per adulti | für Kinder<br>for children<br>para niños<br>per bambini |
| links<br>left<br>izquierda<br>sinistra | 49310-10   | 49310-11  |
| rechts<br>right<br>derecha<br>destra   | 49310-12   | 49310-09  |

Mundsperrer  
 Mouth Gags  
 Abre-Bocas  
 Apribocca

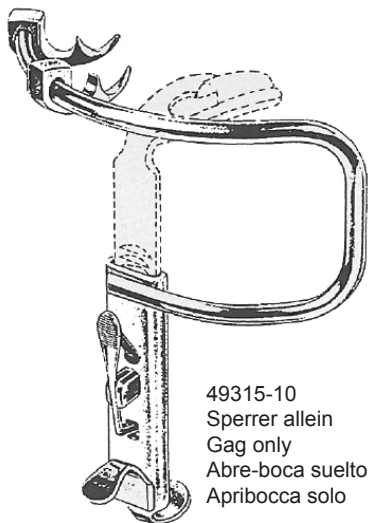

49315-10  
 Sperrer allein  
 Gag only  
 Abre-boca suelto  
 Apribocca solo



37x80 mm  
 49315-01  
 Fig.1



32x75 mm  
 49315-02  
 Fig.2

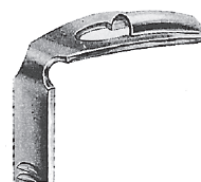

28x65 mm  
 49315-03  
 Fig.3

KILNER-DOUGHTY  
 49315-00  
 compl.

**49317- 00 DINGMANN, komplett**  
 mit 3 auswechselbaren Zungendrucker,  
 2 seitliche Wangenhaken und 2 Zahnhaken

with 3 interchangeable tongue depressors,  
 2 rotating cheek holders,  
 2 movable tooth hooks and thread guide

con 3 baja lenguas intercambiables  
 2 valvas giratorias p. los labios  
 2 ganchos graduables

con 3 depressori intercambiabili,  
 2 valve laterali rotative,  
 2 uncini a denti mobile

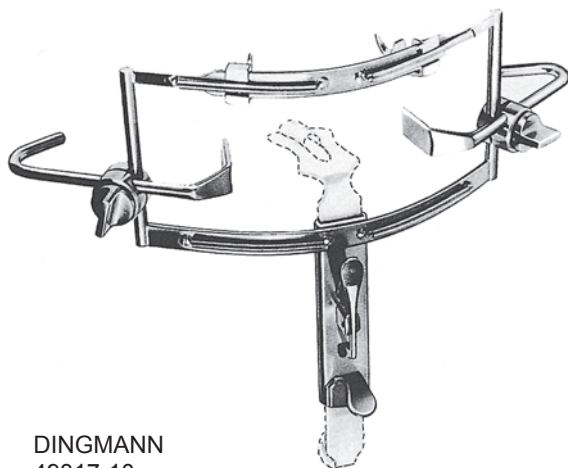

DINGMANN  
 49317-10  
 Sperrer allein, Gag only  
 Abre-boca suelto, Apribocca solo



24x62 mm  
 49317-01  
 Fig. 1

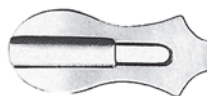

28x65 mm  
 49317-02  
 Fig. 2

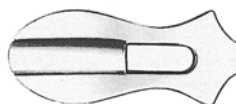

31x75 mm  
 49317-03  
 Fig. 3

Mundsperrer, Zungenspatel  
Mouth Gags, Tongue depressor  
Abre-Bocas, Baja-lengua  
Apribocca, Abbassalingua

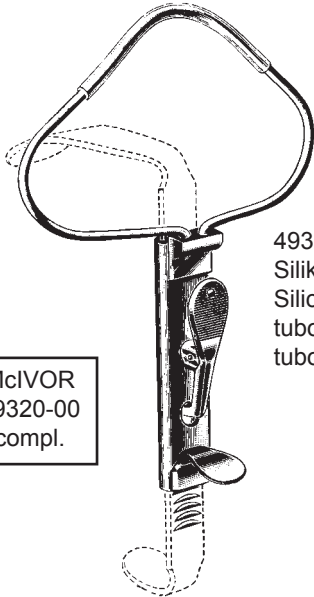

McIVOR  
49320-00  
compl.

49320-10

49320-20  
Silikon-Schlauch  
Silicon Tubing  
tubo de silicona  
tubo in silicone

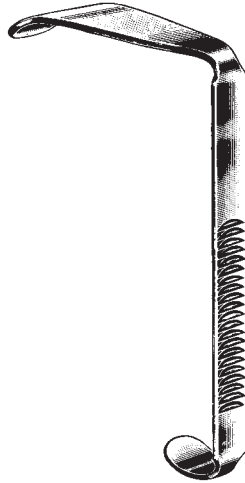

49320-01  
27x95 mm Fig.1

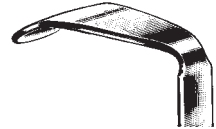

49320-02  
22x85 mm Fig.2

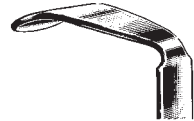

49320-03  
22x75 mm Fig.3



DAVIS-MEYER  
49340-00



Zungenspatel  
Tongue blades  
Baja-lenguas  
Abbassalingua



Wundhaken für Mund-Kiefer-Gesicht  
Retractors, Raspatories for Mouth-, Jaw- and Face Surgery  
Separadores para cirugía de boca -mandíbula- fiscal  
Divaricatori, Periostotomi per bocca, mascella, viso



OBWEGESER  
22 cm, 8<sup>3</sup>/<sub>4</sub>"

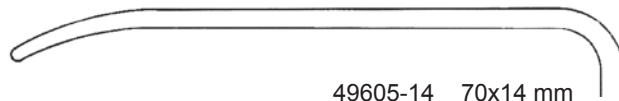
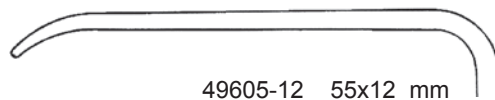
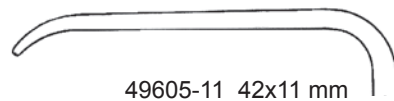
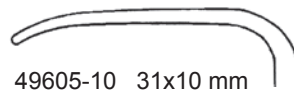
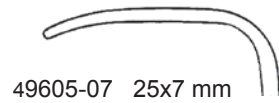

Wundhaken für Mund-Kiefer-Gesicht  
Retractors, Raspatories for Mouth-, Jaw- and Face Surgery  
Separadores para cirugía de boca -mandíbula- fiscal  
Divaricatori, Periostotomi per bocca, mascella, viso



OBWEGESER  
22 cm, 8<sup>3</sup>/<sub>4</sub>"

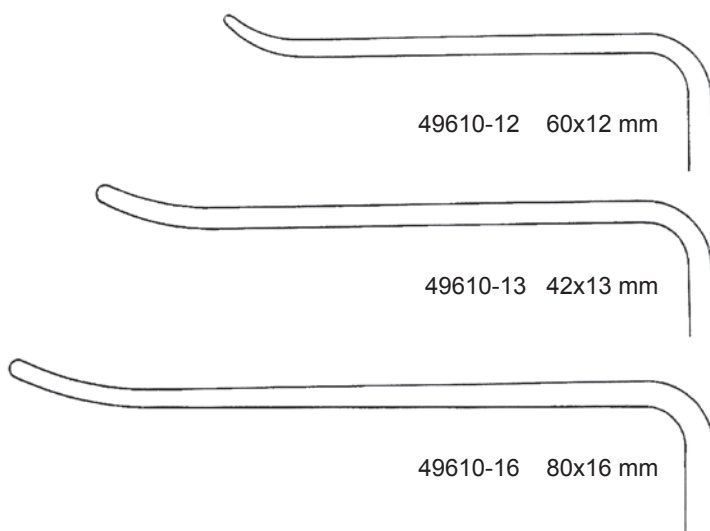

Wundhaken für Mund-Kiefer-Gesicht  
 Retractors, Raspatories for Mouth-, Jaw- and Face Surgery  
 Separadores para cirugía de boca- mandibula- fiscal  
 Divaricatori, per bocca, mascella, viso

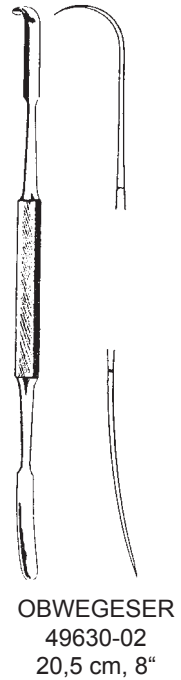
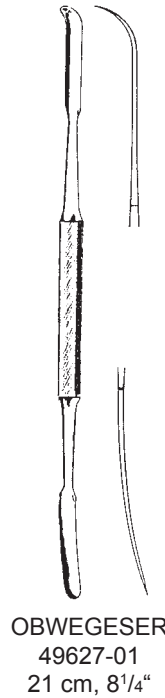
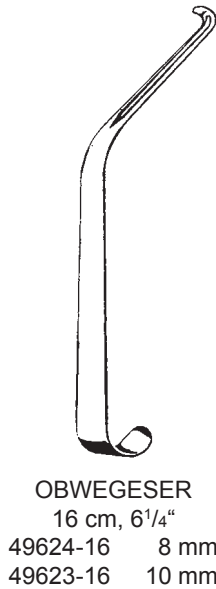
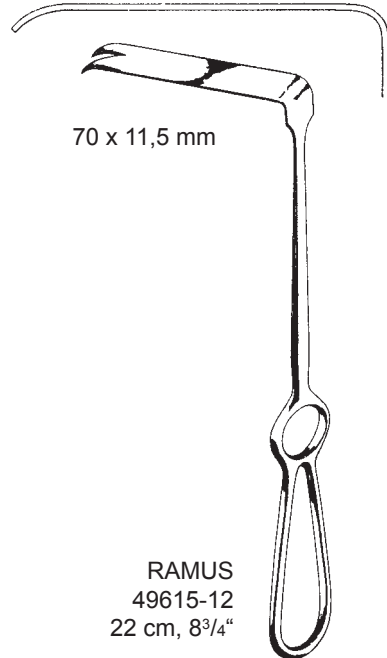
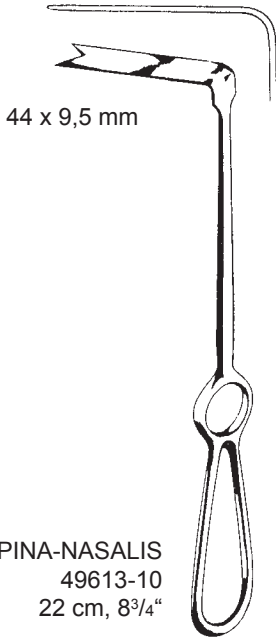

Raspatorien, Elevatoren  
 Periosteal Elevators  
 Legras  
 Periostotomi

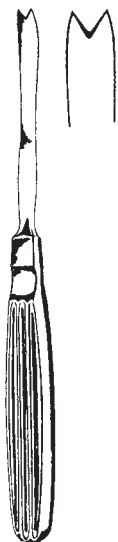

OBWEGESER  
 49635-18 17,5 cm, 7"



OBWEGESER  
 20 cm, 8"

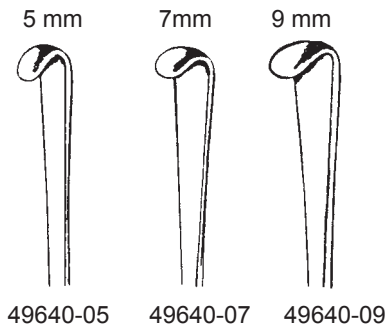

49640-05

49640-07

49640-09



OBWEGESER  
 17,5 cm, 7"

6 mm



49650-06

7 mm



49650-07

9 mm



49650-09

11 mm



49650-11

Raspator, Wundhaken, Elevator  
 Raspatories, Retractor, Elevators  
 Legras, Separadores, Elevadores  
 Periostotomo, Divaricatore, Elevatore

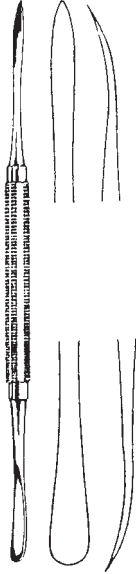

DINGMAN  
 49660-18 18 cm, 7"



19 cm, 7 1/2"

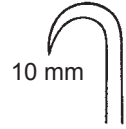

10 mm

49680-10

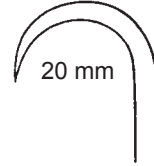

20 mm

49680-20



DINGMAN  
 49685-21 21 cm, 8 1/4"

links left izquierda  
 rechts right derecha

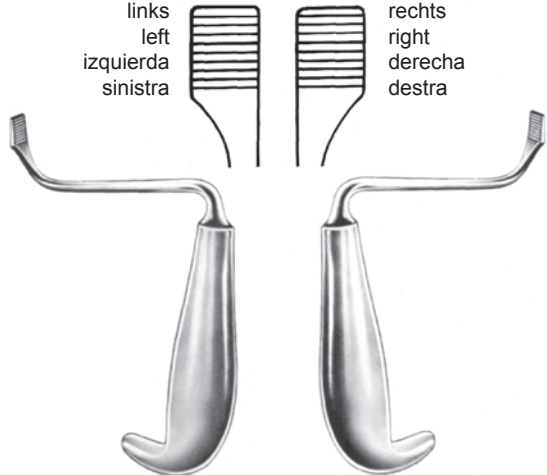

TESSIER  
 49691-15 15 cm, 6"

TESSIER  
 49692-15 15 cm, 6"

Osteotome  
Osteotome  
Osteótomos  
Osteotomi



49666-10 10 mm  
49666-15 15 mm  
49666-20 20 mm

TESSIER  
20,5 cm 8"



49667-10 10 mm  
49667-15 15 mm

TESSIER  
20,5 cm 8"



7 mm

49700-01  
21,5 cm, 8 1/2"



10 mm

49700-02  
21,5 cm, 8 1/2"

Endoskopische Instrumente  
Endoscopic Instruments  
Instrumentos para endoscopia  
Strumenti endoscopici

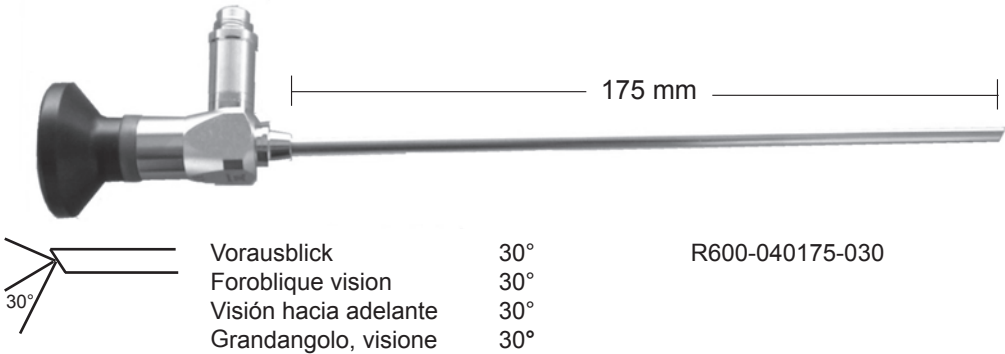

Endoskop für plastische Chirurgie 4 mm Ø, 30° Blickrichtung, 175 mm Nutzlänge, autoklavierbar, integrierte Faser für Ausleuchtung

Endo-Plastic-Scope 4 mm Ø, 30° direction of view, 175 mm working length, autoclavable, integrated fiberoptic bundle for illumination

Optica para endoplastia de 4 mm Ø, vision de 30°, largo útil de 175 mm, autoclavable, con fibra-optica para la iluminación

Optica per endoplastica 4 mm Ø, visione 30°, lunghezza utile 175 mm, autoclavabile con fibre ottiche per illuminazione

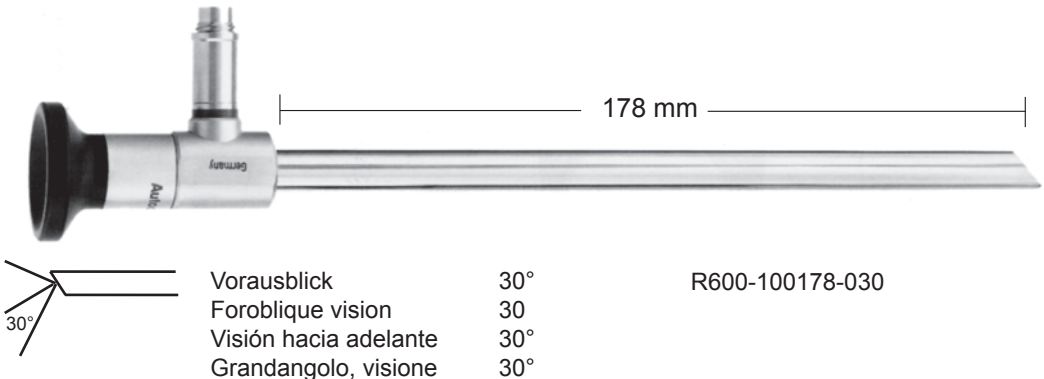

Endo-Plastik-Optik 10 mm Ø, 30° Blickrichtung, 178 mm Nutzlänge, autoklavierbar, integrierte Fiberoptik für Ausleuchtung

Endo-Plastic-Scope 10 mm Ø, 30° direction of view, 178 mm working length, autoclavable, integrated fiberoptic bundle for illumination

Optica para endoplastia de 10 mm Ø, vision de 30°, largo útil de 178 mm, autoclavable, con fibra-optica para la iluminación

Optica per endoplastica 10 mm Ø, visione 30°, lunghezza utile 178 mm, autoclavabile con fibre ottiche per illuminazione





Schaft für Plastische Chirurgie mit 1 Hahn, drehbar, passend für 4 mm Optik mit 175 mm Nutzlänge

Endo-Plastic Sheath with spatula, 1 stopcock rotatable, for 4 mm scope with 175 mm work. length

Camisa para cirugía plástica, una llave giratoria, para óptica de 4 mm, largo útil de 175 mm

Camicia per chirurgia plastica, con spatola, 1 rubinetto rotante, per ottica 4 mm, lunghezza 175 mm

7x17 mm gefenstert / 7x17 mm fenestrated  
7x17 mm fenestrada / 7x17 mm fenestrata

R610-040175-070

11x17 mm gefenstert / 11x17 mm fenestrated  
11x17 mm fenestrada / 11x17 mm fenestrata

R610-040175-110

11x23 mm gefenstert / 11x23 mm fenestrated  
11x23 mm fenestrada / 11x23 mm fenestrata

R610-040175-115

Endoskopische Instrumente  
Endoscopic Instruments  
Instrumentos para endoscopia  
Strumenti endoscopici



R610-040175-001

Schaft für Plastische Chirurgie, schnabelförmig, breit/flach, 1 Hahn, drehbar,  
passend für 4 mm Optik mit 175 mm Nutzlänge

Endo-Plastic Sheath with oblique beak wide/flat, 1 stopcock rotatable,  
suitable f. 4 mm scope with 175 mm working length

Camisa para cirugía plástica en forma de pico, ancho y plano, con una llave giratoria,  
para óptica de 4 mm, largo útil de 175 mm

Camicia per chirurgia plastica, a forma di becco, larga/piatta, 1 rubinetto rotante,  
per ottica 4 mm, lunghezza utile 175 mm

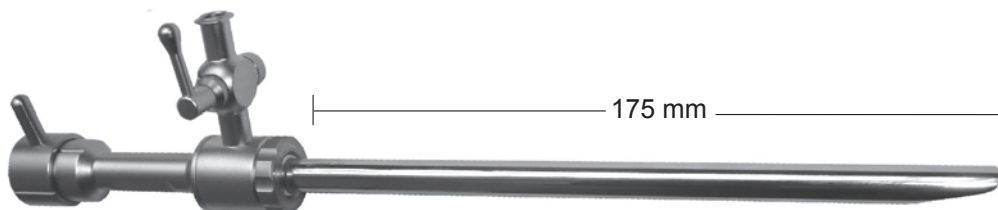

R610-040175-005

Schaft für Plastische Chirurgie, schnabelförmig, 1 Hahn, drehbar, passend für 4 mm Optik mit 175 mm Nutzlänge

Endo-Plastic Sheath with oblique beak, 1 stopcock rotatable, suitable f. 4 mm scope with 175 mm working length

Camisa para cirugía plástica en forma de pico, con una llave giratoria, para óptica de 4 mm, largo útil de 175 mm

Camicia per chirurgia plastica, a forma di becco, 1 rubinetto rotante, per ottica 4 mm, lunghezza utile 175 mm

Endoskopische Instrumente  
Endoscopic Instruments  
Instrumentos para endoscopia  
Strumenti endoscopici

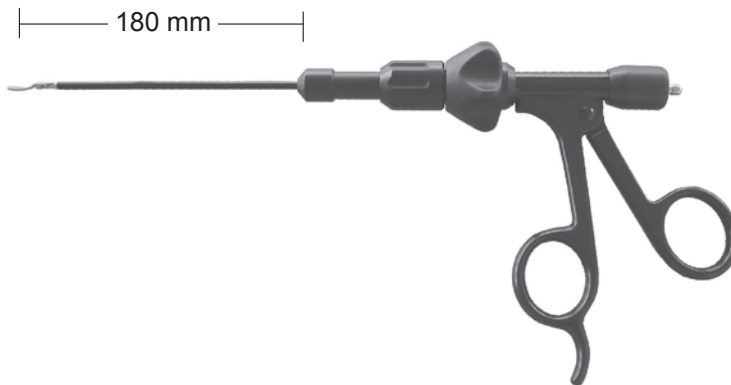

Schere gerade, drehbar für rechte und linke Anwendung, 3 mm Ø,  
Griff mit HF-Anschluß, isoliert

Endoscopic Scissors, straight, insulated shaft, 3 mm Ø,  
handle with HF connector, rotatable

R631-030160-110

Tijera recta, giratoria, para su aplicación hacia la derecha y la izquierda,  
3 mm Ø, mango con contacto de alta frecuencia, aislada  
Forbice, retta, 3 mm Ø, rotante, per uso a destra e a sinistra,  
impugnatura con attacco per alta frequenza



Schere Metzenbaum, gebogen, drehbar für rechte und linke Anwendung,  
3 mm Ø, Griff mit HF-Anschluß, isoliert

Endoscopic Metzenbaum Scissor, curved, insulated shaft, 3 mm Ø,  
handle with HF connector, rotatable

R631-030160-112

Tijera curva, giratoria, para su aplicación hacia la derecha y la izquierda,  
3 mm Ø, mango con contacto de alta frecuencia, aislada  
Forbice Metzenbaum, curva, 3 mm Ø, rotante, per uso a destra e a  
sinistra, impugnatura con attacco per alta frequenza



Hakenschere, drehbar für rechte und linke Anwendung, 3 mm Ø,  
Griff mit HF-Anschluß, isoliert

Endoscopic Micro Hook Scissor, curved shaft for left or right hand,  
3 mm Ø, handle with HF connector, rotatable

R631-030160-116

Tijera de pico, giratoria, para su aplicación hacia la derecha y la izquierda,  
3 mm Ø, mango con contacto de alta frecuencia, aislada  
Forbice ad uncino, curva, 3 mm Ø, rotante, per uso a destra e a sinistra,  
impugnatura con attacco per alta frequenza

Endoskopische Instrumente  
Endoscopic Instruments  
Instrumentos para endoscopia  
Strumenti endoscopici

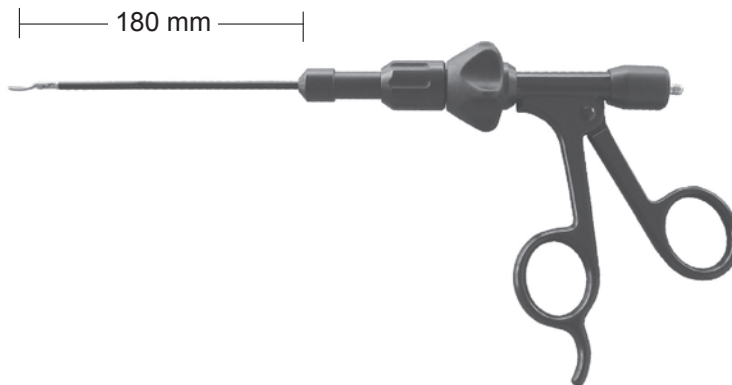

R631-030160-212

Maryland Fasszange gebogen, drehbar, für rechte und linke Anwendung, 3 mm Ø, Griff mit HF-Anschluß, isoliert

Endoscopic Curved Grasper, rotating, insulated shaft for left and right, 3 mm Ø, handle with HF connector

Pinza de agarre raspar tipo Maryland, giratoria, para su aplicación hacia la derecha y la izquierda, 3 mm Ø, mango con contacto de alta frecuencia, aislada  
Pinza da presa Maryland, curva, rotante, per uso a destra e a sinistra, Ø 3 mm, impugnatura con attacco per alta frequenza



R631-030160-224

Delphinzange, drehbar für rechte und linke Anwendung, 3 mm Ø, Griff mit HF-Anschluß, isoliert

Endoscopic Needle Nose Grasper, rotatable for left and right use, 3 mm Ø, handle with HF connector

Pinza de agarre en forma de delfino, giratoria, para su aplicación hacia la derecha y la izquierda, 3 mm Ø, mango con contacto de alta frecuencia, aislada  
Pinza da presa, rotante, per uso a destra e a sinistra, morso a delfino, Ø 3 mm, impugnatura con attacco per alta frequenza



R631-030160-246

Faßzange, retrograd gezahnt, drehbar für rechte und linke Anwendung, 3 mm Ø, Griff mit HF-Anschluß, isoliert

Endoscopic Heavy Grasper, rotatable for left and right, insulated, 3 mm Ø, handle with HF connector

Pinza de agarre, con dentadura en forma retrógrada, giratoria, para la aplicación hacia la derecha y la izquierda, 3 mm Ø, mango con contacto de alta frecuencia, aislada

Pinza da presa, retrograda, rotante, per uso a destra e a sinistra, 3 mm Ø, impugnatura con attacco per alta frequenza

Endoskopische Instrumente  
Endoscopic Instruments  
Instrumentos para endoscopia  
Strumenti endoscopici

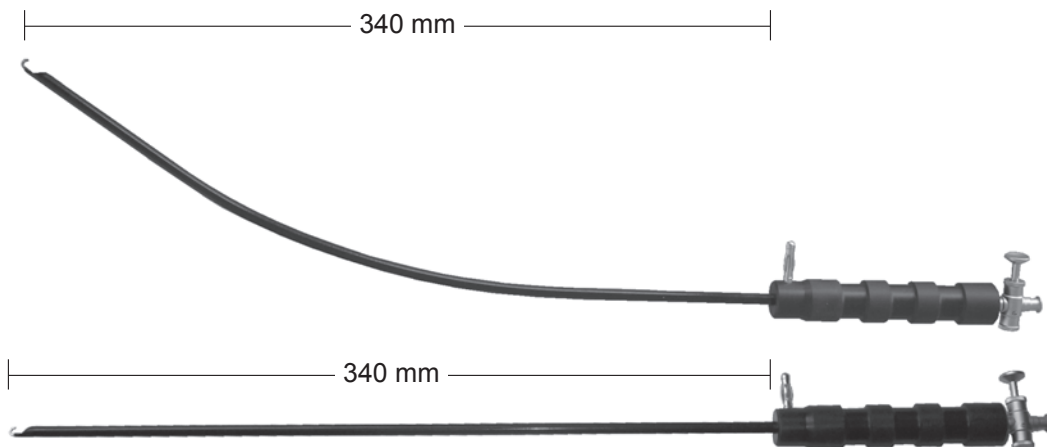

Monopolare Elektroden mit Saugkanal und Hahn, 5 mm Ø, 340 mm Nutzlänge  
Monopolare electrodes with suction port and stopcock, 5 mm Ø, 340 mm working length  
Electrodos monopolares con canal de succión y llave de 5 mm Ø, largo útil de 340 mm  
Elettrodi monopolari con canale d'aspirazione e rubinetto, 5 mm Ø, lunghezza utile 340 mm



J-Haken Elektrode, gerade  
J-Hook electrode straight  
Electroda forma de gancho, recta  
Elettrodo ad uncinetto, retto

R660-050340-002

J-Haken Elektrode, gebogen  
J-Hook electrode curved  
Electroda forma de gancho, curva  
Elettrodo ad uncinetto, curvo

R661-050340-002



Spatel Elektrode, gerade  
Spatula electrode straight  
Electroda en forma de espátula, recta  
Elettrodo a spatola, retto

R660-050340-004

Spatel Elektrode, gebogen  
Spatula electrode curved  
Electroda en forma de espátula, curva  
Elettrodo a spatola, curvo

R661-050340-004

Liposuction-Kanülen  
Liposuction cannulas  
Cánulas de liposucción  
Cannule per liposuzione



20 cm, 8" Ø 3 mm **40010-30**  
30 cm, 12" Ø 3 mm **40011-30**  
30 cm, 12" Ø 4 mm **40012-40**  
40 cm, 16" Ø 4 mm **40013-40**  
30 cm, 12" Ø 5 mm **40014-50**  
30 cm, 12" Ø 6 mm **40015-60**



20 cm, 8" Ø 3 mm **40030-30**  
30 cm, 12" Ø 3 mm **40031-30**  
30 cm, 12" Ø 4 mm **40032-40**  
30 cm, 12" Ø 5 mm **40032-50**  
30 cm, 12" Ø 6 mm **40034-60**



5 cm, 2" Ø 2 mm **40050-20**  
5 cm, 2" Ø 3 mm **40051-30**  
5 cm, 2" Ø 4 mm **40052-40**  
15 cm, 6" Ø 2 mm **40053-20**  
15 cm, 6" Ø 3 mm **40054-30**  
25 cm, 10" Ø 3 mm **40055-30**  
25 cm, 10" Ø 4 mm **40056-40**  
30 cm, 12" Ø 3 mm **40057-30**  
30 cm, 12" Ø 5 mm **40058-50**



15 cm, 6" Ø 2 mm **40090-20**  
15 cm, 6" Ø 3 mm **40091-30**  
15 cm, 6" Ø 4 mm **40092-40**  
25 cm, 10" Ø 3 mm **40093-30**  
25 cm, 10" Ø 4 mm **40094-40**  
25 cm, 10" Ø 5 mm **40095-50**  
30 cm, 12" Ø 5 mm **40096-50**



20 cm, 8" Ø 3 mm **40020-30**  
30 cm, 12" Ø 3 mm **40021-30**  
30 cm, 12" Ø 4 mm **40022-40**  
30 cm, 12" Ø 5 mm **40023-50**  
30 cm, 12" Ø 6 mm **40024-60**



30 cm, 12" Ø 4 mm **40040-40**  
30 cm, 12" Ø 5 mm **40041-50**



20 cm, 8" Ø 3 mm **40060-30**  
30 cm, 12" Ø 3 mm **40061-30**



30 cm, 12" Ø 6 mm **40070-60**  
35 cm, 14" Ø 6 mm **40071-60**



25 cm, 10" Ø 2 mm **40080-20**  
35 cm, 14" Ø 3 mm **40081-20**



30 cm, 12" Ø 3 mm **40100-30**



Liposuction-Kanülen  
 Liposuction cannulas  
 Cánulas de liposucción  
 Cannule per liposuzione



|           |          |  | LL ▼            |                 |
|-----------|----------|--|-----------------|-----------------|
| 5 cm, 2"  | Ø 1,7 mm |  | <b>40110-17</b> | <b>40120-17</b> |
| 5 cm, 2"  | Ø 2,0 mm |  | <b>40111-20</b> | <b>40121-20</b> |
| 5 cm, 2"  | Ø 3,0 mm |  | <b>40112-30</b> | <b>40122-30</b> |
| 10 cm, 4" | Ø 2,0 mm |  | <b>40113-20</b> | <b>40123-20</b> |
| 15 cm, 6" | Ø 1,7 mm |  | <b>40114-17</b> | <b>40124-17</b> |
| 15 cm, 6" | Ø 2,0 mm |  | <b>40115-20</b> | <b>40125-20</b> |
| 15 cm, 6" | Ø 3,0 mm |  | <b>40116-30</b> | <b>40126-30</b> |



|           |          |          | LL ▼            |                 |
|-----------|----------|----------|-----------------|-----------------|
| 10 cm, 4" | Ø 1,7 mm | Ø 0,5 mm | <b>40130-17</b> | <b>40140-17</b> |
| 10 cm, 4" | Ø 2,0 mm | Ø 1,0 mm | <b>40131-20</b> | <b>40141-20</b> |
| 15 cm, 6" | Ø 2,0 mm | Ø 1,0 mm | <b>40132-30</b> | <b>40142-30</b> |



|            |          |          | LL ▼ |                 |                 |
|------------|----------|----------|------|-----------------|-----------------|
| 15 cm, 6"  | Ø 2,0 mm | Ø 1,0 mm | 18   | <b>40150-20</b> | <b>40160-20</b> |
| 15 cm, 6"  | Ø 2,5 mm | Ø 1,2 mm | 18   | <b>40151-25</b> | <b>40161-25</b> |
| 15 cm, 6"  | Ø 3,0 mm | Ø 1,5 mm | 18   | <b>40152-30</b> | <b>40162-30</b> |
| 20 cm, 8"  | Ø 2,5 mm | Ø 1,2 mm | 22   | <b>40153-25</b> | <b>40163-25</b> |
| 20 cm, 8"  | Ø 3,0 mm | Ø 1,5 mm | 22   | <b>40154-30</b> | <b>40164-30</b> |
| 20 cm, 8"  | Ø 4,0 mm | Ø 2,0 mm | 22   | <b>40155-40</b> | <b>40164-40</b> |
| 25 cm, 10" | Ø 2,5 mm | Ø 1,2 mm | 26   | <b>40156-25</b> | <b>40166-25</b> |
| 30 cm, 12" | Ø 3,0 mm | Ø 1,5 mm | 30   | <b>40157-30</b> | <b>40167-30</b> |
| 30 cm, 12" | Ø 4,0 mm | Ø 2,0 mm | 30   | <b>40158-40</b> | <b>40168-40</b> |

◀ LL



Liposuction-Kanülen  
Liposuction cannulas  
Cánulas de liposucción  
Cannule per liposuzione



Griffansatz  
Handle connector  
Emplame mango  
Attacco-manico



◀ LL

Luer-Lock Ansatz  
Luer-Lock connector  
Emplame Luer-Lock  
Attacco Luer-Lock



LL ▼

20 cm, 8" Ø 3,0 mm 40170-30 40180-30



|            |          |          |    |          |          |
|------------|----------|----------|----|----------|----------|
| 20 cm, 8"  | Ø 3,0 mm | Ø 1,5 mm | 22 | 40190-30 | 40200-30 |
| 20 cm, 8"  | Ø 4,0 mm | Ø 2,0 mm | 22 | 40191-40 | 40201-40 |
| 30 cm, 12" | Ø 3,0 mm | Ø 1,5 mm | 30 | 40192-30 | 40202-30 |
| 30 cm, 12" | Ø 4,0 mm | Ø 2,0 mm | 30 | 40193-40 | 40203-40 |

LL ▼



Handgriffe für Kanülen  
Handles for cannulas  
Mangos para cánulas  
Manici per cannule



Ø 13 mm

**40001-13**  
13 cm, 5¼"



**40002-13**  
13 cm, 5¼"



360°



**40003-13**  
13 cm, 5¼"



360°



**40004-13**  
13 cm, 5¼"

LL



**40005-14**  
14 cm, 5½"

LL



**40006-14**  
14 cm, 5½"



**40000-40**  
Ø 40 mm



**40000-50**  
5 cm, 2"

Liposuction-Kanülen  
Liposuction cannulas  
Cánulas de liposucción  
Cannule per liposuzione



|            |        |                 |
|------------|--------|-----------------|
| 15 cm, 6"  | Ø 3 mm | <b>40300-30</b> |
| 15 cm, 6"  | Ø 6 mm | <b>40301-60</b> |
| 25 cm, 10" | Ø 4 mm | <b>40302-40</b> |
| 25 cm, 10" | Ø 6 mm | <b>40303-60</b> |
| 30 cm, 12" | Ø 9 mm | <b>40304-90</b> |



|            |        |                 |
|------------|--------|-----------------|
| 15 cm, 6"  | Ø 4 mm | <b>40400-40</b> |
| 25 cm, 10" | Ø 6 mm | <b>40401-60</b> |
| 30 cm, 12" | Ø 6 mm | <b>40402-60</b> |



|           |        |                 |
|-----------|--------|-----------------|
| 15 cm, 6" | Ø 3 mm | <b>40500-30</b> |
|-----------|--------|-----------------|

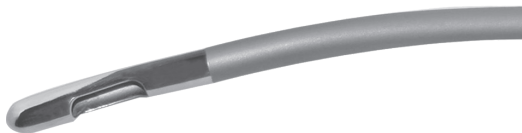

|            |        |                 |
|------------|--------|-----------------|
| 15 cm, 6"  | Ø 6 mm | <b>40501-60</b> |
| 25 cm, 10" | Ø 6 mm | <b>40502-60</b> |



## SET/100 Basic Plastic Surgery – Basis Set Plastische Chirurgie

|    |          |   |
|----|----------|---|
| 1x | 07103-00 | scalpel handle no. 3                            |
| 1x | 07115-00 | scalpel blade fig. 15                           |
| 1x | 09305-14 | JOSEPH, scissors, cvd., 14,5 cm                 |
| 1x | 09310-12 | KILNER, scissors, cvd., 12 cm                   |
| 1x | 09340-11 | IRIS, scissors, str., 11 cm                     |
| 1x | 09341-11 | IRIS, scissors, cvd., 11 cm                     |
| 2x | 11176-12 | ADSON micro, dressing forceps, 12 cm            |
| 2x | 11186-12 | ADSON micro, tissue forceps, 1x2 t., 12 cm      |
| 4x | 13220-12 | HALSTED-MOSQUITO, forceps, str., 12,5 cm        |
| 6x | 13221-12 | HALSTED-MOSQUITO, forceps, cvd., 12,5 cm        |
| 2x | 13320-14 | ROCHESTER-OCHSNER, forceps, 1x2 t., str., 14 cm |
| 4x | 15111-09 | BACKHAUS, towel forceps, 9 cm                   |
| 2x | 17170-18 | FOERSTER, swab forceps, str., 18 cm             |
| 1x | 19216-01 | JOSEPH, hooklet, sharp, 1 prong, 16 cm          |
| 1x | 19216-02 | JOSEPH, hooklet, sharp, 2 prongs, 16 cm         |
| 1x | 19650-10 | WEITLANER, retractor, sharp, 11,5 cm            |
| 1x | 21110-14 | grooved director, 14,5 cm                       |
| 1x | 25137-11 | BABY WEBSTER, needle holder TC, 11 cm           |
| 1x | 25164-15 | CRILE-WOOD, needle holder TC, 15 cm             |
| 1x | 47560-18 | GILLIES, hooklet, delicate, fig. 1, 18cm        |
| 2x | 65110-15 | ALLIS, tissue forceps, 4x5 t., 15 cm            |
| 1x | 89127-08 | bowl round, stainless steel, 80x40 mm, 0,14 l   |

## SET/101 Abdominplasty Set – Abdominoplastik Set

|    |          |  |
|----|----------|--|
| 1x | 07104-00 | scalpel handle no. 4                           |
| 1x | 07120-00 | scalpel blade fig. 20                          |
| 1x | 09165-14 | MAYO, scissors TC, cvd., 14,5 cm               |
| 1x | 10039-23 | KAYE, face lift Supercut scissors, cvd., 23 cm |
| 1x | 10011-19 | GORNEY, face lift scissors, cvd., 18,5 cm      |
| 1x | 11112-18 | POTTS-SMITH, dressing forceps, 18 cm           |
| 1x | 11126-18 | POTTS-SMITH, tissue forceps, 1x2 t., 18 cm     |
| 1x | 11176-12 | ADSON micro, dressing forceps, 12 cm           |
| 1x | 11186-12 | ADSON mirco, tissue forceps, 1x2 t., 12 cm     |
| 1x | 11188-12 | ADSON-BROWN, tissue forceps, 7x7 t., 12 cm     |
| 6x | 15111-13 | BACKHAUS, towel forceps, 13 cm                 |
| 1x | 19102-12 | FARABEUF, retractor, double pair, 12 cm        |
| 2x | 19216-07 | JOSEPH, hooklet, sharp, 2 prongs, 16 cm        |
| 1x | 19364-60 | ISRAEL, retractor, blunt, 50x60 mm, 25 cm      |
| 1x | 25144-13 | HALSEY, needle holder TC, 13 cm                |
| 1x | 25184-16 | MAYO-HEGAR, needle holder TC, 16 cm            |
| 1x | 25184-20 | MAYO-HEGAR, needle holder TC, 20 cm            |

## SET/102 Skin Graft Set – Hautverpflanzung Set

|    |          |   |
|----|----------|---|
| 1x | 03350-15 | tape measure metal, 1,5 m                 |
| 1x | 07103-00 | scalpel handle no. 3                      |
| 1x | 07115-00 | scalpel blade fig. 15                     |
| 1x | 07490-00 | SCHINK, dermatome, 30 cm                  |
| 1x | 09283-15 | METZENBAUM-FINO, scissors, cvd, 15 cm     |
| 1x | 09283-18 | METZENBAUM-FINO, scissors, cvd., 18 cm    |
| 1x | 11260-15 | SEMKEN, dressing forceps, 15,5 cm         |
| 1x | 11270-15 | SEMKEN, tissue forceps, 1x2 t., 15,5 cm   |
| 3x | 13221-12 | HALSTED-MOSQUITO, forceps, cvd., 12,5 cm  |
| 4x | 15111-13 | BACKHAUS, towel forceps, 13 cm            |
| 1x | 19212-01 | GUTHRIE, double hooklet, small, 12 cm     |
| 1x | 19240-10 | SENN-GREEN, retractor, 10x6mm, 15cm       |
| 1x | 25214-18 | DeBAKEY, needle holder TC, 18 cm          |
| 1x | 25164-15 | CRILE-WOOD, needle holder TC, 15 cm       |
| 1x | 47560-18 | GILLIES, hooklet, delicate, fig. 1, 18 cm |
| 2x | 65110-15 | ALLIS, tissue forceps, 4x5 t., 15 cm      |

**SET/103 Nose Correction – Nasenkorrektur Set**

|    |          |   |
|----|----------|---|
| 1x | 07107-00 | scalpel handle no. 7                          |
| 1x | 07115-00 | scalpel blade fig. 15                         |
| 1x | 09304-14 | JOSEPH, scissors, str., 14 cm                 |
| 1x | 09310-12 | KILNER, scissors, cvd., 12 cm                 |
| 1x | 09321-15 | REYNOLDS, scissors, cvd., 15 cm               |
| 1x | 09401-18 | HEYMANN, scissors, 18 cm                      |
| 1x | 11176-12 | ADSON micro, dressing forceps, 12 cm          |
| 1x | 11186-12 | ADSON micro, tissue forceps, 1x2 t., 12 cm    |
| 1x | 11188-12 | ADSON-BROWN, tissue forceps, 7x7 t., 12 cm    |
| 1x | 13220-12 | HALSTED-MOSQUITO, forceps, str., 12,5 cm      |
| 1x | 13223-12 | HALSTED-MOSQUITO, forceps, cvd., 12,5 cm      |
| 1x | 13312-14 | PEAN, forceps, str., 14 cm                    |
| 4x | 15111-13 | BACKHAUS, towel forceps, 13 cm                |
| 1x | 17111-20 | GROSS-MAIER, dressing forceps, cvd., 20 cm    |
| 1x | 19212-01 | GUTHRIE, double hooklet, 12 cm                |
| 1x | 19216-02 | JOSEPH, hooklet, sharp, 2 prongs, 16 cm       |
| 1x | 19218-01 | BARSKY, hook, 15 cm                           |
| 1x | 19230-12 | DESMARRES, retractor, 16 cm                   |
| 1x | 25137-11 | BABY WEBSTER, needle holder TC, 11 cm         |
| 1x | 25164-15 | CRILE-WOOD, needle holder TC, 15 cm           |
| 1x | 33100-01 | FRIEDMAN micro, bone rongeur, str., 14 cm     |
| 1x | 33694-01 | mallet with interchangeable plastic, 18,5 cm  |
| 1x | 33711-16 | WILLIGER, raspatory, str., 16cm               |
| 1x | 33711-20 | LANGENBECK, elevator, 20 cm                   |
| 1x | 45206-14 | LUCAE, ear forceps, 14 cm                     |
| 1x | 47120-35 | KILLIAN, nasal speculum, 35 mm, 13 cm         |
| 1x | 47120-50 | KILLIAN, nasal speculum, 50 mm, 13 cm         |
| 1x | 47224-01 | WEIL-BLAKESLEY, forceps, fig. 1, 45°, 3 mm    |
| 1x | 47256-20 | CAPLAN, nasal cutting forceps, 20 cm          |
| 1x | 47347-20 | GUILLEN, suction raspatory, 19 cm             |
| 1x | 47374-16 | FREER, mucosa knife, 16,5 cm                  |
| 1x | 47423-22 | COTTLE, septum elevator, 22 cm                |
| 1x | 47454-04 | COTTLE, rhinoplastic osteotome, 18 cm         |
| 1x | 47454-07 | COTTLE, rhinoplastic osteotome, 18 cm         |
| 1x | 47470-04 | FOMON, osteotome, 17 cm                       |
| 1x | 47522-05 | FOMON, nasal raspel TC, fig. 5/6, 20 cm       |
| 1x | 47551-16 | AUFRICHT, nasal retractor, 16 cm              |
| 1x | 47555-08 | KILNER, nasal retractor, 8 cm                 |
| 1x | 47565-10 | COTTLE, columella forceps, 10 cm              |
| 1x | 47571-23 | ASCH, septum forceps, str., 23 cm             |
| 1x | 89127-08 | bowl round, stainless steel, 80x40 mm, 0,14 l |



### SET/104 Face Lift Set

|    |          |  |
|----|----------|--|
| 1x | 03370-16 | PITANGUY, facelift marker, 16 cm                   |
| 1x | 07107-00 | scalpel handle no. 7                               |
| 1x | 07115-00 | scalpel blade fig. 15                              |
| 1x | 09345-11 | IRIS, scissors TC, cvd., 11 cm                     |
| 1x | 10015-19 | GORNEY, face lift Supercut scissors, cvd., 18,5 cm |
| 1x | 10045-14 | PECK-JOSEPH, dissecting scissors, cvd., 14,5 cm    |
| 1x | 11176-12 | ADSON micro, dressing forceps, 12 cm               |
| 1x | 11186-12 | ADSON micro, tissue forceps, 1x2 t., 12 cm         |
| 1x | 11188-12 | ADSON-BROWN, tissue forceps, 7x7 t., 12 cm         |
| 1x | 11231-20 | BROPHY, tissue forceps, 1x2 t., 20 cm              |
| 1x | 13364-14 | MARTEL, scalp flap forceps, 14 cm                  |
| 1x | 19102-12 | FARABEUF, retractor double pair, 12 cm             |
| 1x | 19216-02 | JOSEPH, hooklet, sharp, 2 prongs, 16 cm            |
| 1x | 19314-16 | KOCHER-LANGENBECK, retractor, 21 cm                |
| 1x | 19995-38 | FREEMAN, retractor, sharp, 4 prongs, 18 cm         |
| 1x | 25144-13 | HALSEY, needle holder TC, 13 cm                    |
| 1x | 25164-15 | CRILE-WOOD, needle holder TC, 15 cm                |
| 1x | 47560-18 | GILLIES, hooklet, delicate, fig. 1, 18 cm          |

### **SET/105 Eyelid Plastic (Blepharoplasty) – Set zur Lidstraffung (Blepharoplastik)**

|    |          |  |
|----|----------|--|
| 1x | 07103-00 | scalpel handle no. 3                         |
| 1x | 07115-00 | scalpel blade fig. 15                        |
| 1x | 09341-11 | IRIS, scissors, cvd., 11 cm                  |
| 1x | 09362-11 | STEVENS, scissors, str. 11 cm                |
| 1x | 10313-14 | GOMEL, scissors, cvd., 14 cm                 |
| 1x | 11186-12 | ADSON micro, tissue forceps, 1x2 t., 12 cm   |
| 1x | 13220-12 | HALSTED-MOSQUITO, forceps, str., 12,5 cm     |
| 1x | 13221-12 | HALSTED-MOSQUITO, forceps, cvd., 12,5 cm     |
| 4x | 15111-09 | BACKHAUS, towel forceps, 9 cm                |
| 1x | 19216-01 | JOSEPH, hooklet, sharp, 1 prong, 16 cm       |
| 1x | 19216-02 | JOSEPH, hooklet, sharp, 2 prongs, 16 cm      |
| 1x | 19230-12 | DESMARRES retractor, 16 cm                   |
| 1x | 25670-14 | CASTROVIEJO, needle holder, str., 14 cm      |
| 1x | 44150-01 | CASTROVIEJO, suturing forceps, 0,1 mm, 10 cm |
| 1x | 47560-18 | GILLIES, hooklet, delicate, fig. 1, 18 cm    |

## SET/106 Mammoplasty – Mammoplastik Set

|    |          |  |
|----|----------|--|
| 1x | 03340-20 | ruler metal, 20 cm                               |
| 1x | 03500-38 | FREEMAN, marker, 38 mm                           |
| 1x | 03500-42 | FREEMAN, marker, 42 mm                           |
| 1x | 03500-44 | FREEMAN, marker, 44 mm                           |
| 1x | 07107-00 | scalpel handle no. 7                             |
| 1x | 07115-00 | scalpel blade fig. 15                            |
| 1x | 09281-18 | METZENBAUM, scissors, 18 cm                      |
| 1x | 09310-15 | KILNER, scissors, 15 cm                          |
| 1x | 09583-15 | neurosurgery scissors, cvd., 15 cm               |
| 1x | 11102-14 | dressing forceps, 14,5 cm                        |
| 1x | 11186-12 | ADSON micro, tissue forceps, 1x2 t., 12 cm       |
| 2x | 13223-12 | HALSTED-MOSQUITO, micro, forceps, cvd., 12,5 cm  |
| 2x | 13231-12 | HALSTED-MOSQUITO, forceps, cvd., 12,5 cm         |
| 1x | 13475-18 | MIXTER BABY, forceps, 18 cm                      |
| 6x | 15111-13 | BACKHAUS, towel forceps, 13 cm                   |
| 1x | 17110-25 | GROSS-MAIER, dressing forceps, 25 cm             |
| 1x | 19102-12 | FARABEUF, retractor double par, 12 cm            |
| 1x | 19314-12 | KOCHER-LANGENBECK, retractor, 21 cm              |
| 1x | 19999-00 | AGRIS-DINGMAN, breast dissector, set of 2, 36 cm |
| 1x | 19999-02 | TEBBETTS, breast dissector, 33 cm                |
| 1x | 25164-15 | CRILE-WOOD, needle holder TC, 15 cm              |
| 1x | 25180-16 | MAYO-HEGAR, needle holder, 16 cm                 |
| 1x | 47154-20 | JANSEN, nasal forceps, 20 cm                     |
| 1x | 89127-08 | bowl round, stainless steel, 80x40mm, 0,14 l     |

|                  |                   |                   |                   |                   |
|------------------|-------------------|-------------------|-------------------|-------------------|
| 03312-01 .....2  | 07109-10 ..... 11 | 09280-20 ..... 16 | 09345-11.....20   | 09825-12 .....25  |
| 03314-01 .....2  | 07109-13 ..... 11 | 09280-23 ..... 16 | 09346-11.....20   | 09826-12 .....25  |
| 03340-10 .....2  | 07109-15 ..... 11 | 09281-12 ..... 16 | 09348-01 .....21  | 09828-12 .....25  |
| 03340-15 .....2  | 07161-00 ..... 11 | 09281-15 ..... 16 | 09348-02 .....21  | 09829-12 .....25  |
| 03340-20 .....2  | 07162-00 ..... 11 | 09281-18 ..... 16 | 09348-03 .....21  | 09854-11.....26   |
| 03340-30 .....2  | 07165-00 ..... 11 | 09281-20 ..... 16 | 09348-04 .....21  | 09855-11.....26   |
| 03340-50 .....2  | 07167-00 ..... 11 | 09281-23 ..... 16 | 09348-05 .....21  | 09962-14 ..... 13 |
| 03370-16 .....3  | 07296-00 ..... 7  | 09282-15 ..... 17 | 09348-06 .....21  | 09962-17 ..... 13 |
| 03380-30 .....3  | 07490-00 ..... 6  | 09282-18 ..... 17 | 09349-12 .....22  | 09963-14 ..... 13 |
| 03390-30 .....3  | 07490-01 ..... 6  | 09282-20 ..... 17 | 09350-09 .....23  | 09963-17 ..... 13 |
| 03400-38 .....5  | 07490-02 ..... 6  | 09282-23 ..... 17 | 09350-10 .....22  | 09964-15 ..... 14 |
| 03400-42 .....5  | 07495-31 ..... 7  | 09283-15 ..... 17 | 09351-09 .....23  | 09964-17 ..... 14 |
| 03400-45 .....5  | 07496-31 ..... 7  | 09283-18 ..... 17 | 09352-09 .....23  | 09965-15 ..... 14 |
| 03500-34 .....4  | 07498-00 ..... 7  | 09283-20 ..... 17 | 09352-10 .....22  | 09965-17 ..... 14 |
| 03500-36 .....4  | 07499-00 ..... 7  | 09283-23 ..... 17 | 09353-09 .....23  | 09966-11..... 16  |
| 03500-38 .....4  | 07499-01 ..... 7  | 09284-12 ..... 16 | 09354-10 .....23  | 09967-11..... 16  |
| 03500-42 .....4  | 09160-14 ..... 13 | 09284-15 ..... 16 | 09355-10 .....23  | 09970-14 ..... 16 |
| 03500-45 .....4  | 09160-17 ..... 13 | 09284-18 ..... 16 | 09356-10 .....23  | 09970-18 ..... 16 |
| 03500-50 .....4  | 09161-14 ..... 13 | 09284-20 ..... 16 | 09357-10 .....23  | 09970-20 ..... 16 |
| 03501-34 .....4  | 09161-17 ..... 13 | 09284-23 ..... 16 | 09358-11.....22   | 09970-23 ..... 16 |
| 03501-38 .....4  | 09164-14 ..... 13 | 09285-12 ..... 16 | 09360-11.....24   | 09971-14 ..... 16 |
| 03501-45 .....4  | 09164-17 ..... 13 | 09285-15 ..... 16 | 09361-11.....24   | 09971-18 ..... 16 |
| 03505-00 .....4  | 09165-14 ..... 13 | 09285-18 ..... 16 | 09362-11.....24   | 09971-20 ..... 16 |
| 03520-34 .....4  | 09165-17 ..... 13 | 09285-20 ..... 16 | 09363-11.....24   | 09971-23 ..... 16 |
| 03520-38 .....4  | 09170-15 ..... 14 | 09285-23 ..... 16 | 09370-11.....24   | 09980-11.....20   |
| 03520-45 .....4  | 09170-17 ..... 14 | 09286-15 ..... 17 | 09371-11.....24   | 09981-11.....20   |
| 03530-34 .....4  | 09171-15 ..... 14 | 09286-18 ..... 17 | 09374-11.....24   | 09982-12 .....25  |
| 03530-36 .....4  | 09171-17 ..... 14 | 09286-20 ..... 17 | 09375-11.....24   | 09983-12 .....25  |
| 03530-38 .....4  | 09174-15 ..... 14 | 09286-23 ..... 17 | 09401-18 .....27  | 09984-11.....24   |
| 03530-42 .....4  | 09174-17 ..... 14 | 09287-15 ..... 17 | 09403-15 .....27  | 09985-11.....24   |
| 03530-45 .....4  | 09175-15 ..... 14 | 09287-18 ..... 17 | 09405-16 .....27  | 09993-15 ..... 19 |
| 03530-50 .....4  | 09175-17 ..... 14 | 09287-20 ..... 17 | 09405-16TC.....27 | 09995-12 ..... 19 |
| 03540-32 .....4  | 09190-16 ..... 15 | 09287-23 ..... 17 | 09406-10 .....27  | 10010-19 ..... 30 |
| 03540-37 .....4  | 09191-16 ..... 15 | 09302-14 ..... 18 | 09407-10 .....27  | 10011-19.....30   |
| 03540-43 .....4  | 09194-16 ..... 15 | 09303-14 ..... 18 | 09540-16 ..... 19 | 10012-19 ..... 30 |
| 03550-14 .....5  | 09195-16 ..... 15 | 09304-14 ..... 18 | 09541-16 ..... 19 | 10013-19 ..... 30 |
| 03550-16 .....5  | 09202-10 ..... 15 | 09305-14 ..... 18 | 09542-16 ..... 19 | 10014-19 ..... 30 |
| 03560-34 .....5  | 09203-10 ..... 15 | 09310-12 ..... 19 | 09543-16 ..... 19 | 10015-19 ..... 30 |
| 03560-38 .....5  | 09206-10 ..... 15 | 09310-15 ..... 19 | 09544-16 ..... 19 | 10028-14 ..... 31 |
| 03560-42 .....5  | 09207-10 ..... 15 | 09314-12 ..... 19 | 09545-16 ..... 19 | 10029-14 ..... 31 |
| 07103-00 .....8  | 09270-15 ..... 17 | 09321-15 ..... 19 | 09614-19 .....29  | 10030-18 .....31  |
| 07103-01 .....8  | 09270-18 ..... 17 | 09321-18 ..... 19 | 09617-13 .....27  | 10031-18 .....31  |
| 07103-02 .....8  | 09271-15 ..... 17 | 09340-09 .....20  | 09802-09 .....28  | 10032-23 .....31  |
| 07104-00 .....9  | 09271-18 ..... 17 | 09340-10 .....20  | 09802-11.....28   | 10033-23 .....31  |
| 07104-02 .....9  | 09274-15 ..... 17 | 09340-11.....20   | 09804-14 .....28  | 10034-14 .....31  |
| 07105-02 .....9  | 09274-18 ..... 17 | 09341-09 .....20  | 09805-09 .....28  | 10035-14 .....31  |
| 07106-01 .....9  | 09275-15 ..... 17 | 09341-10 .....20  | 09820-13 .....29  | 10036-18 .....31  |
| 07107-00 .....10 | 09275-18 ..... 17 | 09341-11.....20   | 09821-13 .....29  | 10037-18 .....31  |
| 07107-01 .....10 | 09280-12 ..... 16 | 09342-08 .....20  | 09821-13SC.....29 | 10038-23 .....31  |
| 07108-00 .....10 | 09280-15 ..... 16 | 09343-08 .....20  | 09823-12 .....25  | 10039-23 .....31  |
| 07109-03 .....8  | 09280-18 ..... 16 | 09344-11.....20   | 09824-12 .....25  | 10044-14 .....31  |

|                   |                   |                  |                   |                  |
|-------------------|-------------------|------------------|-------------------|------------------|
| 10045-14 .....31  | 10227-11..... 35  | 11114-16 .....36 | 11177-12 ..... 38 | 11274-06.....43  |
| 10048-14 .....31  | 10227-14 ..... 35 | 11114-20 .....36 | 11178-12 ..... 38 | 11274-08.....43  |
| 10049-14 .....31  | 10227-18 ..... 35 | 11114-25 .....36 | 11179-12 ..... 38 | 11274-10.....43  |
| 10050-14 .....31  | 10227-18T .....35 | 11116-18 .....36 | 11180-12 ..... 39 | 11302-17.....43  |
| 10050-18 .....31  | 10227-21 .....35  | 11116-21 .....36 | 11180-12F.....39  | 11302-23.....43  |
| 10051-14 .....31  | 10227-23 ..... 35 | 11116-25 .....36 | 11180-15 ..... 39 | 11303-17.....43  |
| 10051-18 .....31  | 10228-11..... 35  | 11120-10 .....37 | 11181-12 ..... 39 | 11304-17.....43  |
| 10061-19 .....30  | 10228-14 ..... 35 | 11120-11 .....37 | 11181-15 ..... 39 | 11305-17.....44  |
| 10061-19SC...30   | 10228-18 ..... 35 | 11120-13.....37  | 11182-12 ..... 39 | 11310-17.....44  |
| 10061-19TC...30   | 10228-18T .....35 | 11120-14.....37  | 11186-12 ..... 39 | 11311-17.....44  |
| 10061-23 .....30  | 10228-21 ..... 35 | 11120-16.....37  | 11186-15 ..... 39 | 11312-17.....44  |
| 10061-23SC...30   | 10228-23 ..... 35 | 11120-18 .....37 | 11187-12 ..... 39 | 11312-18.....44  |
| 10061-23TC...30   | 10229-11.....35   | 11120-20.....37  | 11187-18 .....41  | 11313-17.....44  |
| 10201-11.....32   | 10229-14 .....35  | 11122-12.....37  | 11187-20 .....41  | 11314-01.....44  |
| 10201-11SC...32   | 10229-18 ..... 35 | 11122-13.....37  | 11187-25 .....41  | 11314-02.....44  |
| 10202-11.....33   | 10229-18T .....35 | 11122-14 .....37 | 11187-30 .....41  | 11315-01.....44  |
| 10202-14 .....33  | 10229-21 ..... 35 | 11122-15 .....37 | 11188-12 .....40  | 11315-02.....44  |
| 10202-14T .....33 | 10229-23 ..... 35 | 11122-18.....37  | 11188-12F.....40  | 11316-14.....45  |
| 10202-18 .....33  | 10230-11.....35   | 11122-21.....37  | 11188-15 .....40  | 11316-16.....45  |
| 10202-18T .....33 | 10230-14 ..... 35 | 11124-15 .....37 | 11189-12 .....40  | 11316-20.....45  |
| 10202-21 .....33  | 10230-18 ..... 35 | 11126-18 .....36 | 11189-15 .....41  | 11317-00.....45  |
| 10202-21T .....33 | 10230-18T .....35 | 11126-21 .....36 | 11189-20 .....41  | 11317-12.....45  |
| 10202-23 .....33  | 10230-21 ..... 35 | 11126-25.....36  | 11189-25 .....41  | 11317-23.....45  |
| 10203-11.....33   | 10230-23 ..... 35 | 11130-11 .....37 | 11190-10 .....41  | 11318-18.....45  |
| 10203-14 .....33  | 11102-10 ..... 36 | 11130-13.....37  | 11191-12 .....40  | 11318-20.....45  |
| 10203-14T .....33 | 11102-11 ..... 36 | 11130-14 .....37 | 11220-17 .....41  | 11318-25.....45  |
| 10203-18 .....33  | 11102-13.....36   | 11130-16.....37  | 11221-17.....41   | 11319-12.....45  |
| 10203-18T .....33 | 11102-14 ..... 36 | 11130-18.....37  | 11222-17.....41   | 11319-14.....45  |
| 10203-21 .....33  | 11102-16 ..... 36 | 11130-20 .....37 | 11223-17.....41   | 11320-18.....45  |
| 10203-21T .....33 | 11102-18 ..... 36 | 11132-16 .....37 | 11224-17.....41   | 11320-23.....45  |
| 10203-23 .....33  | 11102-20 ..... 36 | 11132-18 .....37 | 11225-17.....41   | 11401-01.....46  |
| 10206-11.....32   | 11103-14 ..... 36 | 11132-20 .....37 | 11232-15.....41   | 11403-03.....46  |
| 10206-11SC...32   | 11104-12 ..... 36 | 11140-11 .....37 | 11246-18.....42   | 11403-04.....46  |
| 10207-11.....32   | 11104-13 ..... 36 | 11140-13 .....37 | 11248-18.....42   | 11404-04.....46  |
| 10207-11SC...32   | 11104-14 ..... 36 | 11140-14 .....37 | 11250-14.....42   | 11405-05.....46  |
| 10220-00 .....34  | 11104-15 ..... 36 | 11140-16.....37  | 11252-20.....42   | 11407-07.....46  |
| 10220-00T .....34 | 11104-18 ..... 36 | 11140-18.....37  | 11256-15.....42   | 12090-15D....47  |
| 10220-25 .....34  | 11104-21 ..... 36 | 11140-20 .....37 | 11256-20.....42   | 12090-18D....47  |
| 10220-25T .....34 | 11106-13 ..... 36 | 11150-13.....37  | 11256-25.....42   | 12090-21D....47  |
| 10220-45 .....34  | 11106-15 ..... 36 | 11150-14 .....37 | 11257-15.....42   | 12090-23D....47  |
| 10220-45T .....34 | 11110-11 ..... 36 | 11150-16.....37  | 11258-15.....42   | 12091-15D....47  |
| 10220-60 .....34  | 11110-13 ..... 36 | 11160-13.....37  | 11259-15.....42   | 12091-18D....47  |
| 10220-60T .....34 | 11110-14 ..... 36 | 11160-14 .....37 | 11260-12.....43   | 12091-21D....47  |
| 10220-90 .....34  | 11110-16 ..... 36 | 11160-16.....37  | 11260-15.....43   | 12091-23D....47  |
| 10220-90T .....34 | 11110-18 ..... 36 | 11170-12.....38  | 11261-15.....43   | 12102-12 .....47 |
| 10226-11.....35   | 11110-20 ..... 36 | 11170-12F.....38 | 11270-12.....43   | 12102-12D....47  |
| 10226-14 .....35  | 11110-25 ..... 36 | 11170-15.....38  | 11270-15.....43   | 12102-12T....47  |
| 10226-18 .....35  | 11112-18 ..... 36 | 11174-12.....38  | 11271-15.....43   | 12102-21 .....47 |
| 10226-18T .....35 | 11112-21 ..... 36 | 11174-15.....38  | 11271-18.....43   | 12102-21D....47  |
| 10226-21 .....35  | 11112-25 ..... 36 | 11176-12.....38  | 11272-15.....43   | 12102-23 .....47 |
| 10226-23 .....35  | 11114-14 ..... 36 | 11176-15.....38  | 11273-15.....43   | 12102-23D....47  |

|                    |                   |                   |                     |                   |
|--------------------|-------------------|-------------------|---------------------|-------------------|
| 12103-12 ..... 47  | 12117-18..... 50  | 13230-18 ..... 60 | 13411-18..... 64    | 19217-05 ..... 70 |
| 12103-12D ..... 47 | 12117-21..... 50  | 13230-21 ..... 60 | 19102-12 ..... 65   | 19217-07 ..... 70 |
| 12103-15 ..... 47  | 12117-23..... 50  | 13231-12 ..... 60 | 19102-15 ..... 65   | 19218-01 ..... 71 |
| 12103-15D ..... 47 | 12118-18..... 50  | 13231-14 ..... 60 | 19124-15 ..... 65   | 19218-02 ..... 71 |
| 12104-15 ..... 47  | 12118-21..... 50  | 13231-18 ..... 60 | 19125-14 ..... 65   | 19218-11..... 71  |
| 12104-15D ..... 47 | 12118-23..... 50  | 13231-21 ..... 60 | 19127-11..... 65    | 19220-01 ..... 72 |
| 12104-15T ..... 47 | 12302-16 ..... 51 | 13232-12 ..... 60 | 19168-06 ..... 66   | 19220-02 ..... 72 |
| 12104-18T ..... 47 | 12302-20 ..... 51 | 13233-12 ..... 60 | 19168-08 ..... 66   | 19220-03 ..... 72 |
| 12104-21T ..... 47 | 12302-24 ..... 51 | 13240-14 ..... 61 | 19168-10 ..... 66   | 19220-04 ..... 72 |
| 12104-23T ..... 47 | 12304-16 ..... 51 | 13240-18 ..... 61 | 19168-12 ..... 66   | 19221-01 ..... 72 |
| 12108-12T ..... 47 | 12304-20 ..... 51 | 13241-14 ..... 61 | 19168-17 ..... 66   | 19221-02 ..... 72 |
| 12108-15T ..... 47 | 12304-24 ..... 51 | 13241-18 ..... 61 | 19168-20 ..... 66   | 19221-03 ..... 72 |
| 12108-18 ..... 47  | 12304-30 ..... 51 | 13242-16 ..... 61 | 19168-25 ..... 66   | 19221-04 ..... 72 |
| 12108-18D ..... 47 | 12306-16 ..... 51 | 13243-16 ..... 61 | 19169-25 ..... 66   | 19226-02 ..... 72 |
| 12108-18T ..... 47 | 12306-20 ..... 51 | 13244-14 ..... 61 | 19170-20 ..... 66   | 19226-03 ..... 72 |
| 12108-21T ..... 47 | 12306-24 ..... 51 | 13245-14 ..... 61 | 19170-25 ..... 66   | 19226-04 ..... 72 |
| 12108-23T ..... 47 | 12306-30 ..... 51 | 13250-14 ..... 62 | 19170-32 ..... 66   | 19227-02 ..... 72 |
| 12109-18 ..... 47  | 12308-16 ..... 51 | 13250-18 ..... 62 | 19170-40 ..... 66   | 19227-03 ..... 72 |
| 12109-18D ..... 47 | 12308-20 ..... 51 | 13251-14 ..... 62 | 19170-45 ..... 66   | 19227-04 ..... 72 |
| 12109-21 ..... 47  | 12308-24 ..... 51 | 13251-18 ..... 62 | 19170-50 ..... 66   | 19229-02 ..... 72 |
| 12109-21D ..... 47 | 12308-30 ..... 51 | 13254-14 ..... 62 | 19170-65 ..... 66   | 19229-03 ..... 72 |
| 12109-23 ..... 47  | 12309-16 ..... 51 | 13255-14 ..... 62 | 19170-76 ..... 66   | 19230-10 ..... 73 |
| 12109-23D ..... 47 | 12309-20 ..... 51 | 13256-14 ..... 61 | 19180-19 ..... 67   | 19230-12 ..... 73 |
| 12112-15D ..... 48 | 12309-24 ..... 51 | 13257-14 ..... 61 | 19181-22 ..... 67   | 19230-14 ..... 73 |
| 12112-15T ..... 48 | 12309-30 ..... 51 | 13258-16 ..... 61 | 19181-25 ..... 67   | 19230-16 ..... 73 |
| 12112-18D ..... 48 | 12310-16 ..... 51 | 13259-16 ..... 61 | 19183-25 ..... 67   | 19230-18 ..... 73 |
| 12112-18T ..... 48 | 12310-20 ..... 51 | 13260-14 ..... 62 | 19183-25CL ..... 68 | 19234-00 ..... 73 |
| 12112-21D ..... 48 | 12310-24 ..... 51 | 13261-14 ..... 62 | 19185-25 ..... 67   | 19237-16 ..... 73 |
| 12112-21T ..... 48 | 12310-30 ..... 51 | 13262-16 ..... 62 | 19187-25 ..... 67   | 19270-02 ..... 73 |
| 12112-23D ..... 48 | 13210-10 ..... 59 | 13263-16 ..... 62 | 19188-12 ..... 68   | 19270-03 ..... 73 |
| 12112-23T ..... 48 | 13211-10 ..... 59 | 13264-16 ..... 62 | 19188-12CL ..... 68 | 19270-04 ..... 73 |
| 12114-15D ..... 48 | 13212-10 ..... 59 | 13265-16 ..... 62 | 19188-25 ..... 68   | 19270-06 ..... 73 |
| 12114-15T ..... 48 | 13213-10 ..... 59 | 13270-14 ..... 61 | 19188-25CL ..... 68 | 19271-02 ..... 73 |
| 12114-18D ..... 48 | 13214-10 ..... 59 | 13271-14 ..... 61 | 19210-12 ..... 69   | 19271-03 ..... 73 |
| 12114-18T ..... 48 | 13215-10 ..... 59 | 13310-13 ..... 63 | 19211-12 ..... 69   | 19271-04 ..... 73 |
| 12114-21D ..... 48 | 13220-12 ..... 60 | 13310-14 ..... 63 | 19212-01 ..... 69   | 19271-06 ..... 73 |
| 12114-21T ..... 48 | 13220-14 ..... 60 | 13310-16 ..... 63 | 19212-02 ..... 69   | 19302-01 ..... 74 |
| 12114-23D ..... 48 | 13220-18 ..... 60 | 13311-13 ..... 63 | 19213-12 ..... 69   | 19302-02 ..... 74 |
| 12114-23T ..... 48 | 13220-21 ..... 60 | 13311-14 ..... 63 | 19214-13 ..... 70   | 19302-03 ..... 74 |
| 12115-15 ..... 49  | 13221-12 ..... 60 | 13311-16 ..... 63 | 19214-18 ..... 70   | 19302-04 ..... 74 |
| 12115-15T ..... 49 | 13221-14 ..... 60 | 13320-13 ..... 63 | 19215-01 ..... 70   | 19302-05 ..... 74 |
| 12115-18 ..... 49  | 13221-18 ..... 60 | 13320-14 ..... 63 | 19215-02 ..... 70   | 19302-06 ..... 74 |
| 12115-18T ..... 49 | 13221-21 ..... 60 | 13320-16 ..... 63 | 19215-03 ..... 70   | 19307-01 ..... 74 |
| 12115-21 ..... 49  | 13222-12 ..... 60 | 13321-13 ..... 63 | 19215-13 ..... 70   | 19307-02 ..... 74 |
| 12115-21T ..... 49 | 13223-12 ..... 60 | 13321-14 ..... 63 | 19215-18 ..... 70   | 19610-07 ..... 75 |
| 12115-23 ..... 49  | 13224-12 ..... 60 | 13321-16 ..... 63 | 19216-01 ..... 70   | 19611-07 ..... 75 |
| 12115-23T ..... 49 | 13225-12 ..... 60 | 13380-15 ..... 63 | 19216-02 ..... 70   | 19620-07 ..... 75 |
| 12116-15 ..... 49  | 13226-12 ..... 60 | 13381-15 ..... 63 | 19216-05 ..... 70   | 19620-10 ..... 75 |
| 12116-18 ..... 49  | 13227-12 ..... 60 | 13382-15 ..... 63 | 19216-07 ..... 70   | 19621-07 ..... 75 |
| 12116-21 ..... 49  | 13230-12 ..... 60 | 13383-15 ..... 63 | 19216-10 ..... 70   | 19621-10 ..... 75 |
| 12116-23 ..... 49  | 13230-14 ..... 60 | 13410-18 ..... 64 | 19217-03 ..... 70   | 19630-10 ..... 75 |

|                   |                     |                    |                    |                    |
|-------------------|---------------------|--------------------|--------------------|--------------------|
| 19631-10 ..... 75 | 19998-05 ..... 84   | 25214-20 ..... 92  | 25672-23D ..... 96 | 33652-03 ..... 132 |
| 19634-10 ..... 75 | 19998-11 ..... 84   | 25214-23 ..... 92  | 25673-14 ..... 96  | 33652-04 ..... 132 |
| 19635-10 ..... 75 | 19998-12 ..... 84   | 25224-13 ..... 93  | 25673-14D ..... 96 | 33652-05 ..... 132 |
| 19650-10 ..... 76 | 19999-00 ..... 81   | 25224-15 ..... 93  | 25673-14T ..... 96 | 33652-06 ..... 132 |
| 19651-10 ..... 76 | 19999-01 ..... 81   | 25224-18 ..... 93  | 25673-18 ..... 96  | 33652-08 ..... 132 |
| 19670-14 ..... 76 | 19999-02 ..... 81   | 25224-20 ..... 93  | 25673-18D ..... 96 | 33652-10 ..... 132 |
| 19671-14 ..... 76 | 19999-03 ..... 81   | 25225-13 ..... 93  | 25673-18T ..... 96 | 33652-12 ..... 132 |
| 19741-01 ..... 77 | 19999-04 ..... 82   | 25225-15 ..... 93  | 25673-21T ..... 96 | 33652-15 ..... 132 |
| 19741-02 ..... 77 | 19999-05 ..... 81   | 25225-18 ..... 93  | 25674-14 ..... 96  | 33654-02 ..... 132 |
| 19741-03 ..... 77 | 19999-06 ..... 82   | 25225-20 ..... 93  | 25674-18 ..... 96  | 33654-03 ..... 132 |
| 19741-04 ..... 77 | 19999-10 ..... 79   | 25230-18 ..... 93  | 25674-21 ..... 96  | 33654-04 ..... 132 |
| 19741-05 ..... 77 | 19999-22 ..... 82   | 25230-20 ..... 93  | 25675-14 ..... 96  | 33654-05 ..... 132 |
| 19741-06 ..... 77 | 19999-29 ..... 82   | 25405-12 ..... 93  | 25675-18 ..... 96  | 33654-06 ..... 132 |
| 19741-07 ..... 77 | 19999-30 ..... 79   | 25406-12 ..... 93  | 25676-14 ..... 96  | 33654-08 ..... 132 |
| 19741-08 ..... 77 | 19999-30CL ..... 79 | 25407-12 ..... 93  | 25677-14 ..... 96  | 33654-10 ..... 132 |
| 19741-09 ..... 77 | 19999-31 ..... 81   | 25408-12 ..... 93  | 25691-18 ..... 96  | 33654-12 ..... 132 |
| 19741-10 ..... 77 | 19999-40 ..... 79   | 25410-14 ..... 93  | 25700-18 ..... 95  | 33654-15 ..... 132 |
| 19741-11 ..... 77 | 19999-50 ..... 79   | 25410-17 ..... 93  | 25701-18 ..... 95  | 33686-25 ..... 100 |
| 19741-12 ..... 77 | 19999-50CL ..... 79 | 25414-14 ..... 93  | 25720-12 ..... 95  | 33693-32 ..... 100 |
| 19741-13 ..... 77 | 25110-12 ..... 91   | 25414-17 ..... 93  | 25720-12D ..... 95 | 33694-01 ..... 100 |
| 19960-01 ..... 78 | 25114-12 ..... 91   | 25414-18 ..... 93  | 25720-13 ..... 95  | 33694-02 ..... 100 |
| 19960-02 ..... 78 | 25128-13 ..... 91   | 25434-11 ..... 94  | 25720-13D ..... 95 | 33694-03 ..... 100 |
| 19960-03 ..... 78 | 25129-13 ..... 91   | 25434-13 ..... 94  | 25720-14 ..... 95  | 33696-75 ..... 100 |
| 19960-04 ..... 78 | 25130-13 ..... 91   | 25434-16 ..... 94  | 25720-14D ..... 95 | 33698-98 ..... 100 |
| 19960-05 ..... 78 | 25134-13 ..... 91   | 25660-12 ..... 95  | 25730-18 ..... 95  | 33700-05 ..... 100 |
| 19960-06 ..... 78 | 25136-11 ..... 91   | 25660-13 ..... 95  | 25730-18D ..... 95 | 33711-16 ..... 101 |
| 19960-07 ..... 78 | 25137-11 ..... 91   | 25660-14 ..... 95  | 25730-21 ..... 95  | 33711-20 ..... 101 |
| 19970-01 ..... 80 | 25140-13 ..... 91   | 25661-12 ..... 95  | 25730-21D ..... 95 | 33711-21 ..... 101 |
| 19970-23 ..... 80 | 25144-13 ..... 91   | 25661-13 ..... 95  | 25730-23 ..... 95  | 33712-16 ..... 101 |
| 19970-24 ..... 80 | 25150-12 ..... 92   | 25661-14 ..... 95  | 25730-23D ..... 95 | 33713-17 ..... 101 |
| 19980-00 ..... 78 | 25150-14 ..... 92   | 25668-18 ..... 96  | 25731-12 ..... 95  | 33718-16 ..... 101 |
| 19980-01 ..... 78 | 25154-12 ..... 92   | 25668-21 ..... 96  | 25731-13 ..... 95  | 33719-17 ..... 101 |
| 19980-02 ..... 78 | 25154-14 ..... 92   | 25668-23 ..... 96  | 25731-14 ..... 95  | 33720-19 ..... 102 |
| 19980-03 ..... 78 | 25160-15 ..... 92   | 25670-14 ..... 96  | 25731-18 ..... 95  | 33720-21 ..... 102 |
| 19980-04 ..... 78 | 25160-18 ..... 92   | 25670-18 ..... 96  | 25731-18D ..... 95 | 34554-15 ..... 97  |
| 19980-05 ..... 78 | 25164-15 ..... 92   | 25670-21 ..... 96  | 25731-21 ..... 95  | 34554-18 ..... 97  |
| 19980-06 ..... 78 | 25164-18 ..... 92   | 25671-12D ..... 95 | 25731-21D ..... 95 | 34554-20 ..... 97  |
| 19980-18 ..... 84 | 25164-20 ..... 92   | 25671-13D ..... 95 | 25731-23 ..... 95  | 34555-15 ..... 97  |
| 19989-22 ..... 82 | 25164-23 ..... 92   | 25671-14 ..... 96  | 25731-23D ..... 95 | 34555-18 ..... 97  |
| 19989-29 ..... 82 | 25180-12 ..... 92   | 25671-14D ..... 95 | 33100-01 ..... 98  | 34555-20 ..... 97  |
| 19990-18 ..... 83 | 25180-14 ..... 92   | 25671-18 ..... 96  | 33100-02 ..... 98  | 34556-18 ..... 97  |
| 19991-18 ..... 83 | 25180-16 ..... 92   | 25672-14 ..... 96  | 33101-12 ..... 98  | 40000-40 ..... 162 |
| 19992-31 ..... 80 | 25180-18 ..... 92   | 25672-14D ..... 96 | 33101-14 ..... 98  | 40000-50 ..... 162 |
| 19995-22 ..... 84 | 25180-20 ..... 92   | 25672-14T ..... 96 | 33201-18 ..... 98  | 40001-13 ..... 162 |
| 19995-38 ..... 84 | 25184-12 ..... 92   | 25672-18 ..... 96  | 33211-15 ..... 98  | 40002-13 ..... 162 |
| 19996-04 ..... 84 | 25184-14 ..... 92   | 25672-18D ..... 96 | 33213-15 ..... 98  | 40003-13 ..... 162 |
| 19996-18 ..... 84 | 25184-16 ..... 92   | 25672-18T ..... 96 | 33280-15 ..... 99  | 40004-13 ..... 162 |
| 19997-09 ..... 84 | 25184-18 ..... 92   | 25672-21 ..... 96  | 33281-15 ..... 99  | 40005-14 ..... 162 |
| 19998-01 ..... 84 | 25184-20 ..... 92   | 25672-21D ..... 96 | 33282-19 ..... 99  | 40006-14 ..... 162 |
| 19998-02 ..... 84 | 25214-16 ..... 92   | 25672-21T ..... 96 | 33283-17 ..... 99  | 40010-30 ..... 159 |
| 19998-03 ..... 84 | 25214-18 ..... 92   | 25672-23 ..... 96  | 33652-02 ..... 132 | 40011-30 ..... 159 |

|                    |                    |                    |                    |                    |
|--------------------|--------------------|--------------------|--------------------|--------------------|
| 40012-40 ..... 159 | 40125-20 ..... 160 | 41069-20 ..... 85  | 44150-15 ..... 55  | 47169-18 ..... 118 |
| 40013-40 ..... 159 | 40126-30 ..... 160 | 41290-21 ..... 107 | 44254-09 ..... 55  | 47185-18 ..... 118 |
| 40014-50 ..... 159 | 40130-17 ..... 160 | 41295-06 ..... 108 | 44256-09 ..... 55  | 47191-01 ..... 119 |
| 40015-60 ..... 159 | 40131-20 ..... 160 | 41295-07 ..... 108 | 44258-09 ..... 55  | 47191-02 ..... 119 |
| 40020-30 ..... 159 | 40132-30 ..... 160 | 41295-08 ..... 108 | 44425-10 ..... 55  | 47191-03 ..... 119 |
| 40021-30 ..... 159 | 40140-17 ..... 160 | 41295-09 ..... 108 | 45201-11 ..... 57  | 47191-04 ..... 119 |
| 40022-40 ..... 159 | 40141-20 ..... 160 | 41295-10 ..... 108 | 45206-14 ..... 57  | 47192-16 ..... 119 |
| 40023-50 ..... 159 | 40142-30 ..... 160 | 41295-11 ..... 108 | 45206-16 ..... 57  | 47195-01 ..... 119 |
| 40024-60 ..... 159 | 40150-20 ..... 160 | 41295-12 ..... 108 | 45208-14 ..... 57  | 47195-02 ..... 119 |
| 40030-30 ..... 159 | 40151-25 ..... 160 | 41297-06 ..... 108 | 47102-01 ..... 110 | 47197-01 ..... 119 |
| 40031-30 ..... 159 | 40152-30 ..... 160 | 41297-07 ..... 108 | 47102-02 ..... 110 | 47197-02 ..... 119 |
| 40032-40 ..... 159 | 40153-25 ..... 160 | 41297-08 ..... 108 | 47102-03 ..... 110 | 47223-01 ..... 120 |
| 40032-50 ..... 159 | 40154-30 ..... 160 | 41297-09 ..... 108 | 47103-01 ..... 111 | 47223-02 ..... 120 |
| 40034-60 ..... 159 | 40155-40 ..... 160 | 41297-10 ..... 108 | 47103-02 ..... 111 | 47223-03 ..... 120 |
| 40040-40 ..... 159 | 40156-25 ..... 160 | 41297-11 ..... 108 | 47103-03 ..... 111 | 47223-04 ..... 120 |
| 40041-50 ..... 159 | 40157-30 ..... 160 | 41297-12 ..... 108 | 47112-01 ..... 112 | 47223-05 ..... 120 |
| 40050-20 ..... 159 | 40158-40 ..... 160 | 41299-03 ..... 107 | 47112-02 ..... 112 | 47224-01 ..... 120 |
| 40051-30 ..... 159 | 40160-20 ..... 160 | 41299-05 ..... 107 | 47112-03 ..... 112 | 47224-02 ..... 120 |
| 40052-40 ..... 159 | 40161-25 ..... 160 | 41299-07 ..... 107 | 47116-13 ..... 112 | 47224-03 ..... 120 |
| 40053-20 ..... 159 | 40162-30 ..... 160 | 43150-11 ..... 58  | 47118-13 ..... 112 | 47224-04 ..... 120 |
| 40054-30 ..... 159 | 40163-25 ..... 160 | 43370-12 ..... 86  | 47120-35 ..... 113 | 47224-05 ..... 120 |
| 40055-30 ..... 159 | 40164-30 ..... 160 | 43372-13 ..... 86  | 47120-35CL. 113    | 47225-01 ..... 120 |
| 40056-40 ..... 159 | 40164-40 ..... 160 | 43373-13 ..... 86  | 47120-35S... 114   | 47225-02 ..... 120 |
| 40057-30 ..... 159 | 40166-25 ..... 160 | 43376-13 ..... 86  | 47120-50 ..... 113 | 47225-03 ..... 120 |
| 40058-50 ..... 159 | 40167-30 ..... 160 | 43377-13 ..... 86  | 47120-50CL. 113    | 47225-04 ..... 120 |
| 40060-30 ..... 159 | 40168-40 ..... 160 | 43378-13 ..... 86  | 47120-50S... 114   | 47226-01 ..... 120 |
| 40061-30 ..... 159 | 40170-30 ..... 161 | 43583-07 ..... 5   | 47120-75 ..... 113 | 47226-02 ..... 120 |
| 40070-60 ..... 159 | 40180-30 ..... 161 | 43583-18 ..... 5   | 47120-75CL. 113    | 47226-03 ..... 120 |
| 40071-60 ..... 159 | 40190-30 ..... 161 | 43810-10 ..... 52  | 47120-75S... 114   | 47227-01 ..... 120 |
| 40080-20 ..... 159 | 40191-40 ..... 161 | 43811-10 ..... 52  | 47120-90 ..... 113 | 47227-02 ..... 120 |
| 40081-20 ..... 159 | 40192-30 ..... 161 | 43813-10 ..... 52  | 47120-90CL. 113    | 47227-03 ..... 120 |
| 40090-20 ..... 159 | 40193-40 ..... 161 | 43820-10 ..... 52  | 47120-90S... 114   | 47237-01 ..... 121 |
| 40091-30 ..... 159 | 40200-30 ..... 161 | 43821-10 ..... 52  | 47124-35 ..... 115 | 47237-02 ..... 121 |
| 40092-40 ..... 159 | 40201-40 ..... 161 | 43823-10 ..... 52  | 47124-35CL. 115    | 47239-01 ..... 121 |
| 40093-30 ..... 159 | 40202-30 ..... 161 | 43940-05 ..... 53  | 47124-35S... 116   | 47239-02 ..... 121 |
| 40094-40 ..... 159 | 40203-40 ..... 161 | 43940-08 ..... 53  | 47124-50 ..... 115 | 47242-00 ..... 121 |
| 40095-50 ..... 159 | 40300-30 ..... 163 | 43942-05 ..... 53  | 47124-50CL. 115    | 47242-01 ..... 121 |
| 40096-50 ..... 159 | 40301-60 ..... 163 | 43942-08 ..... 53  | 47124-50S... 116   | 47251-21 ..... 122 |
| 40100-30 ..... 159 | 40302-40 ..... 163 | 43950-10 ..... 54  | 47124-75 ..... 115 | 47256-20 ..... 122 |
| 40110-17 ..... 160 | 40303-60 ..... 163 | 43952-10 ..... 54  | 47124-75CL. 115    | 47323-19 ..... 123 |
| 40111-20 ..... 160 | 40304-90 ..... 163 | 43953-10 ..... 54  | 47124-75S... 116   | 47325-19 ..... 123 |
| 40112-30 ..... 160 | 40400-40 ..... 163 | 44015-20 ..... 55  | 47124-90 ..... 115 | 47347-20 ..... 109 |
| 40113-20 ..... 160 | 40401-60 ..... 163 | 44015-27 ..... 55  | 47124-90CL. 115    | 47370-16 ..... 124 |
| 40114-17 ..... 160 | 40402-60 ..... 163 | 44076-05 ..... 56  | 47124-90S... 116   | 47371-16 ..... 124 |
| 40115-20 ..... 160 | 40500-30 ..... 163 | 44076-10 ..... 56  | 47151-15 ..... 57  | 47372-16 ..... 124 |
| 40116-30 ..... 160 | 40501-60 ..... 163 | 44078-05 ..... 56  | 47151-18 ..... 57  | 47373-16 ..... 124 |
| 40120-17 ..... 160 | 40502-60 ..... 163 | 44078-10 ..... 56  | 47154-20 ..... 57  | 47374-16 ..... 124 |
| 40121-20 ..... 160 | 41054-20 ..... 85  | 44150-01 ..... 55  | 47158-20 ..... 117 | 47375-16 ..... 124 |
| 40122-30 ..... 160 | 41056-18 ..... 85  | 44150-03 ..... 55  | 47159-20 ..... 117 | 47375-19 ..... 124 |
| 40123-20 ..... 160 | 41058-18 ..... 85  | 44150-05 ..... 55  | 47161-16 ..... 117 | 47376-16 ..... 124 |
| 40124-17 ..... 160 | 41068-20 ..... 85  | 44150-10 ..... 55  | 47161-20 ..... 117 | 47379-16 ..... 125 |



|                    |                    |                    |                    |                    |
|--------------------|--------------------|--------------------|--------------------|--------------------|
| 47380-15 ..... 125 | 47463-14 ..... 129 | 47523-02 ..... 134 | 49274-13 ..... 141 | 49623-16 ..... 148 |
| 47382-15 ..... 125 | 47470-04 ..... 127 | 47524-01 ..... 134 | 49274-15 ..... 141 | 49624-16 ..... 148 |
| 47384-15 ..... 125 | 47470-05 ..... 127 | 47525-20 ..... 134 | 49278-01 ..... 105 | 49627-01 ..... 148 |
| 47385-15 ..... 125 | 47470-06 ..... 127 | 47526-20 ..... 134 | 49278-02 ..... 105 | 49630-02 ..... 148 |
| 47386-01 ..... 125 | 47470-07 ..... 127 | 47530-00 ..... 138 | 49280-18 ..... 105 | 49635-18 ..... 149 |
| 47386-02 ..... 125 | 47471-02 ..... 127 | 47530-01 ..... 138 | 49281-01 ..... 106 | 49640-05 ..... 149 |
| 47390-03 ..... 126 | 47471-03 ..... 127 | 47530-02 ..... 138 | 49281-02 ..... 106 | 49640-07 ..... 149 |
| 47390-04 ..... 126 | 47471-04 ..... 127 | 47532-19 ..... 138 | 49310-00 ..... 142 | 49640-09 ..... 149 |
| 47390-05 ..... 126 | 47471-05 ..... 127 | 47533-19 ..... 138 | 49310-01 ..... 142 | 49650-06 ..... 149 |
| 47392-03 ..... 126 | 47471-06 ..... 127 | 47534-19 ..... 138 | 49310-02 ..... 142 | 49650-07 ..... 149 |
| 47392-04 ..... 126 | 47471-07 ..... 127 | 47535-01 ..... 139 | 49310-03 ..... 142 | 49650-09 ..... 149 |
| 47392-05 ..... 126 | 47471-08 ..... 127 | 47535-02 ..... 139 | 49310-04 ..... 142 | 49650-11 ..... 149 |
| 47410-04 ..... 102 | 47471-10 ..... 127 | 47538-01 ..... 87  | 49310-05 ..... 142 | 49660-18 ..... 150 |
| 47410-05 ..... 102 | 47471-12 ..... 127 | 47538-02 ..... 87  | 49310-09 ..... 142 | 49666-10 ..... 151 |
| 47411-16 ..... 102 | 47472-10 ..... 127 | 47538-03 ..... 87  | 49310-10 ..... 142 | 49666-15 ..... 151 |
| 47414-21 ..... 102 | 47472-12 ..... 127 | 47538-04 ..... 87  | 49310-11 ..... 142 | 49666-20 ..... 151 |
| 47415-18 ..... 102 | 47472-14 ..... 127 | 47540-16 ..... 87  | 49310-12 ..... 142 | 49667-10 ..... 151 |
| 47417-19 ..... 102 | 47472-16 ..... 127 | 47550-11 ..... 87  | 49315-00 ..... 143 | 49667-15 ..... 151 |
| 47419-19 ..... 102 | 47473-01 ..... 130 | 47550-11CL ... 87  | 49315-01 ..... 143 | 49680-10 ..... 150 |
| 47420-01 ..... 103 | 47473-02 ..... 130 | 47551-16 ..... 87  | 49315-02 ..... 143 | 49680-20 ..... 150 |
| 47420-02 ..... 103 | 47473-03 ..... 130 | 47551-16CL ... 87  | 49315-03 ..... 143 | 49685-21 ..... 150 |
| 47420-03 ..... 103 | 47474-01 ..... 130 | 47552-16 ..... 87  | 49315-10 ..... 143 | 49691-15 ..... 150 |
| 47420-04 ..... 103 | 47474-02 ..... 130 | 47553-15 ..... 87  | 49317-00 ..... 143 | 49692-15 ..... 150 |
| 47420-20 ..... 103 | 47474-03 ..... 130 | 47554-01 ..... 88  | 49317-01 ..... 143 | 49700-01 ..... 151 |
| 47421-21 ..... 103 | 47475-04 ..... 131 | 47554-02 ..... 88  | 49317-02 ..... 143 | 49700-02 ..... 151 |
| 47421-23 ..... 103 | 47475-06 ..... 131 | 47554-03 ..... 88  | 49317-03 ..... 143 | 55116-15 ..... 90  |
| 47422-22 ..... 103 | 47475-08 ..... 131 | 47555-08 ..... 88  | 49317-10 ..... 143 | 55117-17 ..... 90  |
| 47423-22 ..... 104 | 47481-05 ..... 130 | 47556-16 ..... 88  | 49320-00 ..... 144 | 55120-15 ..... 90  |
| 47424-16 ..... 104 | 47482-05 ..... 132 | 47557-17 ..... 88  | 49320-01 ..... 144 | 73193-30 ..... 5   |
| 47425-19 ..... 104 | 47484-04 ..... 132 | 47558-15 ..... 88  | 49320-02 ..... 144 | 93250-15T ..... 95 |
| 47426-22 ..... 104 | 47484-06 ..... 132 | 47559-20 ..... 88  | 9320-03 ..... 144  | 93250-18T ..... 95 |
| 47428-21 ..... 104 | 47484-08 ..... 132 | 47560-18 ..... 89  | 49320-10 ..... 144 | 93250-21T ..... 95 |
| 47430-22 ..... 104 | 47486-16 ..... 132 | 47562-18 ..... 89  | 49320-20 ..... 144 | 93251-15T ..... 95 |
| 47450-04 ..... 128 | 47487-16 ..... 132 | 47563-22 ..... 89  | 49340-00 ..... 144 | 93251-18T ..... 95 |
| 47451-04 ..... 128 | 47489-16 ..... 132 | 47564-16 ..... 89  | 49342-01 ..... 145 | 93251-21T ..... 95 |
| 47454-04 ..... 129 | 47502-16 ..... 134 | 47565-10 ..... 57  | 49342-02 ..... 145 | 93260-15T ..... 95 |
| 47454-07 ..... 129 | 47504-18 ..... 134 | 47566-12 ..... 89  | 49342-03 ..... 145 | 93260-18T ..... 95 |
| 47454-09 ..... 129 | 47507-17 ..... 134 | 47567-11 ..... 89  | 49342-04 ..... 145 | 93260-21T ..... 95 |
| 47454-12 ..... 129 | 47507-18 ..... 134 | 47568-08 ..... 89  | 49342-05 ..... 145 | 93261-15T ..... 95 |
| 47455-06 ..... 129 | 47511-21 ..... 135 | 47571-23 ..... 140 | 49605-07 ..... 146 | 93261-18T ..... 95 |
| 47458-04 ..... 129 | 47513-21 ..... 135 | 47572-23 ..... 140 | 49605-10 ..... 146 | 93261-21T ..... 95 |
| 47458-07 ..... 129 | 47514-16 ..... 135 | 47573-23 ..... 140 | 49605-11 ..... 146 | 93385-21 ..... 12  |
| 47458-09 ..... 129 | 47516-16 ..... 135 | 47575-23 ..... 140 | 49605-12 ..... 146 | 93385-25 ..... 12  |
| 47458-12 ..... 129 | 47518-21 ..... 135 | 49115-01 ..... 141 | 49605-14 ..... 146 | 93390-21 ..... 12  |
| 47460-04 ..... 129 | 47520-21 ..... 136 | 49115-01CL 141     | 49605-16 ..... 146 |                    |
| 47460-07 ..... 129 | 47522-01 ..... 137 | 49115-02 ..... 141 | 49610-12 ..... 147 |                    |
| 47460-12 ..... 129 | 47522-04 ..... 137 | 49115-02CL 141     | 49610-13 ..... 147 |                    |
| 47461-00 ..... 133 | 47522-05 ..... 137 | 49117-11 ..... 141 | 49610-16 ..... 147 |                    |
| 47462-00 ..... 133 | 47522-07 ..... 137 | 49257-20 ..... 122 | 49613-10 ..... 148 |                    |
| 47463-10 ..... 129 | 47522-09 ..... 137 | 49274-09 ..... 141 | 49615-12 ..... 148 |                    |
| 47463-12 ..... 129 | 47523-01 ..... 134 | 49274-11 ..... 141 | 49620-15 ..... 148 |                    |

**A**

|   |           |
|---|-----------|
| ACKERMANN Markierungsinstrument .....     | 5         |
| ADSON, Arterienklemme .....               | 64        |
| ADSON, Durahaken .....                    | 85        |
| ADSON, Pinzette .....                     | 38-39     |
| ADSON, Saugrohr .....                     | 107       |
| ADSON-BROWN, Pinzette .....               | 40        |
| AGRIS-DINGMAN, Brustdissektor .....       | 81        |
| ALM, Wundhaken .....                      | 75        |
| Anatomische Pinzette .....                | 36        |
| ANDERSON, Hauthäkchen .....               | 79        |
| ANDREW, Zungenspatel .....                | 141       |
| Antrumraspel, WIENER .....                | 134       |
| Arterienklemme, ADSON .....               | 64        |
| Arterienklemme, COLLER-CRILE .....        | 61        |
| Arterienklemme, CRILE .....               | 62        |
| Arterienklemme, CRILE-RANKIN .....        | 62        |
| Arterienklemme, HALSTED-MOSQUITO .....    | 60        |
| Arterienklemme, HARTMANN .....            | 59        |
| Arterienklemme, JACOBSON Micro .....      | 60        |
| Arterienklemme, KELLY .....               | 61        |
| Arterienklemme, KELLY-RANKIN .....        | 61        |
| Arterienklemme, LERICHE .....             | 63        |
| Arterienklemme, PROVIDENCE-HOSPITAL ..... | 61        |
| Arterienklemme, ROCHESTER-OCHSNER .....   | 63        |
| Arterienklemme, ROCHESTER-PEAN .....      | 63        |
| ASCH, Septumrichtzange .....              | 140       |
| Atrauma Pinzette, DeBAKEY .....           | 47-48, 51 |
| AUFRICHT, Nasenhaken .....                | 87        |
| AUFRICHT, Nasenraspel .....               | 135       |

**B**

|                                     |     |
|-------------------------------------|-----|
| BABY OLSEN-HEGAR, Nadelhalter ..... | 93  |
| BABY WEBSTER, Nadelhalter .....     | 91  |
| BALLENGER, Schwingmesser .....      | 126 |
| BALLENGER, Septumelevator .....     | 104 |
| BARON, Saugrohr .....               | 107 |
| BARRAQUER, Cilienpinzette .....     | 55  |
| BARRAQUER, Nadelhalter .....        | 95  |
| BARSKY, Hauthäkchen .....           | 71  |
| BAUMGARTNER, Nadelhalter .....      | 92  |
| BEASELEY BABCOCK, Pinzette .....    | 39  |
| Beckenzirkel, COLLIER .....         | 5   |
| BERKE, Muskelpinzette .....         | 55  |
| BERRY, TC-Drahtzange .....          | 97  |

|   |     |
|---|-----|
| BEUSE, Face-Lift-Schere .....                   | 31  |
| BEYER, Hohlmeißelzange .....                    | 98  |
| BIGGS, Wundhaken .....                          | 79  |
| BISHOP-HARMAN, Irispinzette .....               | 53  |
| BLAIR, Gaumenspalt-Elevator .....               | 106 |
| Blepharoplastik Schere, GREENBERG-PAR .....     | 32  |
| Blepharoplastik Schere, KAYE .....              | 32  |
| BÖHLER, Hohlmeißelzange .....                   | 98  |
| BÖHLER, Knochensplitterzange .....              | 99  |
| BOIES, Elevator .....                           | 102 |
| BONN, Schere .....                              | 20  |
| BONNEY, Pinzette .....                          | 45  |
| BREAST, Wundhaken .....                         | 80  |
| BROWN, Pinzette .....                           | 41  |
| BRUENINGS, Septumzange .....                    | 119 |
| Brustdissektor, AGRIS-DINGMAN .....             | 81  |
| Brustdissektor, MacCOLLUM-DINGMAN .....         | 81  |
| Brustdissektor, LOCKWOOD .....                  | 82  |
| Brustdissektor, REYNOLDS (Transauxillary) ..... | 81  |
| Brustdissektor, SILVERSTEIN .....               | 82  |
| Brustdissektor, TEBBETS .....                   | 81  |
| Brustspatel .....                               | 80  |
| Bügel, McIVOR .....                             | 144 |

**C**

|                                      |       |
|--------------------------------------|-------|
| CAPLAN, Nasenscheren .....           | 122   |
| CASTROVIEJO, Meßinstrument .....     | 5     |
| CASTROVIEJO, Meßzirkel .....         | 5     |
| CASTROVIEJO, Mikro-Nadelhalter ..... | 96    |
| CASTROVIEJO, Nahtpinzette .....      | 55    |
| CHADWICK, Zahnfleischschere .....    | 26    |
| Chalazionspinzette, DESMARRES .....  | 55    |
| Chirurgische Pinzette .....          | 37    |
| Cilienpinzette, BARRAQUER .....      | 55    |
| CINELLI, Septummeißel .....          | 127   |
| COLLER-CRILE, Arterienklemme .....   | 61    |
| COLLIER, Beckenzirkel .....          | 5     |
| COLLIN-DUVAL, Faßpinzette .....      | 42    |
| Columella-Pinzette, COTTLE .....     | 57    |
| CONVERSE, Nasenhaken .....           | 87,89 |
| CONVERSE, Nasenmesser .....          | 125   |
| CONVERSE/WILMER/WALTER, Schere ..... | 22    |
| CORONAL, Wundhaken .....             | 84    |
| COTTLE, Columella-Pinzette .....     | 57    |
| COTTLE, Fixierpinzette .....         | 57    |
| COTTLE, Hauthäkchen .....            | 88-89 |
| COTTLE, Knorpelquetscher .....       | 133   |

|  |         |
|--|---------|
| COTTLE, Nasenhaken .....                     | 87      |
| COTTLE, Nasenmesser .....                    | 125     |
| COTTLE, Nasenschere .....                    | 27      |
| COTTLE, Nasenspekula .....                   | 115-116 |
| COTTLE, Osteotom .....                       | 129     |
| COTTLE, Schere .....                         | 22      |
| COTTLE, Septumelevator .....                 | 103-104 |
| COTTLE, Septummeißel .....                   | 129     |
| COTTLE, Septumosteotom .....                 | 129     |
| FOMON, Septumosteotom .....                  | 127     |
| SHEEHAN, Septumosteotom .....                | 127     |
| COTTLE, Stahlhammer .....                    | 100     |
| COTTLE-JOSEPH, Septumelevator .....          | 103     |
| COTTLE-KAZANJIAN, Knochensplitterzange ..... | 99      |
| COTTLE-MASING, Nasenschere .....             | 27      |
| COTTLE-NEIVERT, Hauthäkchen .....            | 88      |
| CRAIG, Septumzange .....                     | 119     |
| CRILE, Arterienklemme .....                  | 62      |
| CRILE, Nervhaken .....                       | 85      |
| CRILE, Wundhaken .....                       | 65      |
| CRILE-RANKIN, Arterienklemme .....           | 62      |
| CRILE-WOOD, Nadelhalter .....                | 92      |
| CRONIN, Gaumenspalt-Messer .....             | 105     |
| CUSHING (TAYLOR), Pinzette .....             | 44      |
| CUSHING, Nervenhaken .....                   | 85      |
| CUSHING, Pinzette .....                      | 41      |

**D**

|  |       |
|--|-------|
| Darmspatel, RIBBON .....                     | 66    |
| D'ASSUMPCAO, Markierungsinstrument .....     | 3     |
| Daumenhäkchen, MILLARD .....                 | 84    |
| DAVIS-BOYLE, Mundsperrerr .....              | 142   |
| DAVIS-BOYLE, Zungenspatel .....              | 142   |
| DAVIS-MEYER, Mundsperrerr .....              | 144   |
| DEAVER, Wundhaken .....                      | 67-68 |
| DeBAKEY, Atrauma Pinzette .....              | 49-51 |
| DeBAKEY, Nadelhalter .....                   | 92    |
| Delphinzange für plastische Endoskopie ..... | 157   |
| DERF, Nadelhalter .....                      | 91    |
| Dermatom, HUMBY .....                        | 7     |
| Dermatom, SCHINK .....                       | 6     |
| Dermatom, SILVER .....                       | 7     |
| Dermatom, WATSON .....                       | 7     |
| DESMARRES, Chalazionspinzette .....          | 55    |
| DESMARRES, Wundhaken .....                   | 73    |
| DINGMANN, Elevator .....                     | 150   |
| DINGMANN, Mundsperrerr .....                 | 143   |

|  |     |
|--|-----|
| DINGMANN, Nasenraspel.....             | 138 |
| DINGMANN, Raspator.....                | 150 |
| DINGMANN, Sperrer.....                 | 143 |
| DINGMANN, Zungenspatel.....            | 143 |
| Dissektor, GORNEY.....                 | 102 |
| Drahtbürste.....                       | 138 |
| Drahtzange TC, BERRY.....              | 97  |
| Drahtzange TC,<br>MAYO-HABERISSER..... | 97  |
| Durahaken, ADSON.....                  | 85  |
| DURANTE, Faßpinzette.....              | 45  |
| DUVAL, Faßpinzette.....                | 42  |

**E**

|   |         |
|---|---------|
| Elevator, BALLENGER.....                | 104     |
| Elevator, BOIES.....                    | 102     |
| Elevator, COTTLE-JOSEPH.....            | 103-104 |
| Elevator, DINGMANN.....                 | 150     |
| Elevator, FREER.....                    | 102     |
| Elevator, HAJEK-BALLENGER.....          | 104     |
| Elevator, HOWARTH.....                  | 103     |
| Elevator, JOSEPH.....                   | 102     |
| Elevator, KILLIAN.....                  | 103-104 |
| Elevator, MASING.....                   | 102     |
| Elevator, McKENTY.....                  | 102-103 |
| Elevator, OBWEGESER.....                | 149     |
| Elevator, PENNINGTON.....               | 103     |
| Elevator, PIERCE.....                   | 103     |
| Elevator, SINUS.....                    | 103     |
| Endo-Dissektor.....                     | 77      |
| Endo-Dissektor, LANGENBECK.....         | 77      |
| Endo-Dissektor,<br>MINI-LANGENBECK..... | 77      |
| Endoskop.....                           | 152     |
| Ersatzbacken f. Hammer.....             | 100     |
| Ersatzklinge f. SCHINK Dermatome.....   | 6       |
| Ersatzklingen f. Dermatome.....         | 7       |

**F**

|  |    |
|--|----|
| Face-Lift-Schere, BEUSE.....             | 31 |
| Face-Lift-Schere, GORNEY.....            | 30 |
| Face-Lift-Schere,<br>GORNEY-FREEMAN..... | 30 |
| Face-Lift-Schere, KAYE.....              | 31 |
| Face-Lift-Schere, PECK-JOSEPH.....       | 31 |
| Fadenpinzette, OCHSNER.....              | 45 |
| Fadenschere, LITTAUER.....               | 28 |
| Fadenschere, O'BRIEN.....                | 28 |
| Fadenschere, SPENCER.....                | 28 |
| FARABEUF, Wundhaken.....                 | 65 |
| Faßpinzette, COLLIN-DUVAL.....           | 42 |

|   |        |
|---|--------|
| Faßpinzette, DURANTE.....                 | 45     |
| Faßpinzette, DUVAL.....                   | 42     |
| Faßpinzette, RUSS. MODELL.....            | 42     |
| Faßzange f. plastische<br>Endoskopie..... | 157    |
| Faßzange, MARYLAND.....                   | 157    |
| FERRIERA, Wundhaken.....                  | 78     |
| FERRIS-SMITH, Pinzette.....               | 42     |
| Finger-Goniometer.....                    | 2      |
| FINSEN, Wundhaken.....                    | 75     |
| Fixierpinzette, COTTLE.....               | 57     |
| Fixierpinzette, GREEN.....                | 56     |
| Flachmeißel, MINI-LAMBOTTE.....           | 132    |
| FOMON, Hauthäkchen.....                   | 88     |
| FOMON, Nasenraspel.....                   | 136    |
| FOMON, Nasenschere.....                   | 27     |
| FOMON, Raspator.....                      | 101    |
| FOMON, Septummeißel.....                  | 127    |
| FRAZIER, Hauthäkchen.....                 | 70     |
| FRAZIER/FERGUSON,<br>Saugrohr.....        | 108    |
| FREEMAN,<br>Markierungsinstrument.....    | 4      |
| FREEMAN, Wundhaken.....                   | 68, 84 |
| FREER, Hauthäkchen.....                   | 88     |
| FREER, Mukosamesser.....                  | 124    |
| FREER, Septumelevator.....                | 102    |
| FREER, Septumhohlmeißel.....              | 132    |
| FREER, Septummeißel.....                  | 128    |
| FRIEDMANN, Hohlmeißelzange.....           | 98     |

**G**

|  |       |
|--|-------|
| Gaumenspalt-Elevator, BLAIR.....         | 106   |
| Gaumenspalter, Raspatorium.....          | 105   |
| Gaumenspalt-Messer, CRIONIN.....         | 105   |
| Gefäßpinzette, STILLE-BARRAYA.....       | 45    |
| GERALD, Pinzette.....                    | 43-44 |
| GERZOG, Hammer.....                      | 100   |
| Gewebefaßpinzette, SINGLEY.....          | 45    |
| GILLIES, Hauthäkchen.....                | 89    |
| GILLIES, Nadelhalter.....                | 94    |
| GILLIES, Pinzetten.....                  | 43    |
| GLABELLA, Nasenraspel.....               | 134   |
| GOLDMAN-FOX, Zahnfleissschere.....       | 29    |
| Goniometer, Finger.....                  | 2     |
| GORNEY, Dissektor.....                   | 102   |
| GORNEY, Face-Lift-Schere.....            | 30    |
| GORNEY Nasenscheren.....                 | 122   |
| GORNEY, Wundhaken.....                   | 84    |
| GORNEY-FREEMAN,<br>Face-Lift-Schere..... | 30    |

|   |     |
|---|-----|
| GRADLE, Schere.....                           | 23  |
| GRAEFE, Hauthäkchen.....                      | 69  |
| GRAEFE, Irispinzette.....                     | 52  |
| GRAEFE, Pinzette.....                         | 41  |
| GRAEFE, Schere.....                           | 22  |
| GREEN, Fixierpinzette.....                    | 56  |
| GREENBERG-PAR, Blepharoplastik<br>Schere..... | 32  |
| GROSSMAN,<br>Markierungsinstrument.....       | 4   |
| GUILLEN, Saugraspatorium.....                 | 109 |
| GUTHRIE, Hauthäkchen.....                     | 69  |

**H**

|   |       |
|---|-------|
| HAJEK, Septumhohlmeißel.....                  | 132   |
| HAJEK-BALLENGER,<br>Septumelevator.....       | 104   |
| Hakenschere für plastische<br>Endoskopie..... | 156   |
| HALPREN Markierungsinstrument.....            | 5     |
| HALSEY, Nadelhalter.....                      | 91    |
| HALSTED-MOSQUITO,<br>Arterienklemme.....      | 60    |
| Hammer.....                                   | 100   |
| Hammer, COTTLE.....                           | 100   |
| Hammer, GERZOG.....                           | 100   |
| Hammer, MEAD.....                             | 100   |
| Hammer, PARTSCH.....                          | 100   |
| Hammer, QUISLING.....                         | 100   |
| HARTMANN, Arterienklemme.....                 | 59    |
| HARTMANN, Nasenspekula.....                   | 111   |
| HARTMANN, Polypenzange.....                   | 117   |
| HARTMANN-HALLE,<br>Nasenspekula.....          | 110   |
| Hauthäkchen, FRAZIER.....                     | 70    |
| Hauthäkchen, ANDERSON.....                    | 84    |
| Hauthäkchen, BARSKY.....                      | 71    |
| Hauthäkchen, COTTLE.....                      | 88-89 |
| Hauthäkchen, COTTLE-NEIVERT.....              | 88    |
| Hauthäkchen, FOMON.....                       | 88    |
| Hauthäkchen, FREER.....                       | 88    |
| Hauthäkchen, GILLIES.....                     | 89    |
| Hauthäkchen, GRAEFE.....                      | 69    |
| Hauthäkchen, GUTHRIE.....                     | 69    |
| Hauthäkchen, HUMBY.....                       | 71    |
| Hauthäkchen, JOSEPH.....                      | 70    |
| Hauthäkchen, KLEINERT-KUTZ.....               | 70    |
| Hauthäkchen, REDA.....                        | 72    |
| Hauthäkchen, TYRELL.....                      | 69    |
| HEYMANN, Nasenschere.....                     | 27    |

|                                    |     |
|------------------------------------|-----|
| HEYMANN-KNIGHT, Polypenzange ..... | 118 |
| Hohlmeißel, FREER .....            | 132 |
| Hohlmeißel, HAJEK .....            | 132 |
| Hohlmeißel, KILLIAN .....          | 130 |
| Hohlmeißel, KILLIAN-CLAUS .....    | 132 |
| Hohlmeißel, WEST .....             | 132 |
| Hohlmeißelzange, BEYER .....       | 98  |
| Hohlmeißelzange, BÖHLER .....      | 98  |
| Hohlmeißelzange, FRIEDMANN .....   | 98  |
| HOLZHEIMER, Wundsperrerr .....     | 75  |
| HOWARTH, Septumelevator .....      | 103 |
| HUMBY, Dermatome .....             | 7   |
| HUMBY, Hauthäkchen .....           | 71  |

**I**

|                                   |    |
|-----------------------------------|----|
| IRIS, Schere .....                | 20 |
| Irishäkchen, O'CONNOR .....       | 86 |
| Irishäkchen, WIENER .....         | 86 |
| Irispinzette, BISHOP-HARMAN ..... | 53 |
| Irispinzette, GRAEFE .....        | 52 |

**J**

|  |         |
|--|---------|
| JACKSON, Trachealhaken .....           | 90      |
| JACOBSON Mikro, Arterienklemme .....   | 60      |
| JAEGER, Lidplatte .....                | 58      |
| JAMESON, Präparierschere .....         | 19      |
| JANSEN, Wundsperrerr .....             | 75      |
| JANSEN-GRUENWALD,<br>Ohrpinzette ..... | 57      |
| JENNINGS, Mundsperrerr .....           | 141     |
| J-Haken Elektrode, monopolar .....     | 158     |
| JOSEPH (LEWIS), Nasenraspel .....      | 135     |
| JOSEPH, Hauthäkchen .....              | 70      |
| JOSEPH, Nasenmesser .....              | 124-125 |
| JOSEPH, Nasenraspel .....              | 134     |
| JOSEPH, Nasensäge .....                | 138-139 |
| JOSEPH, Präparierschere .....          | 18      |
| JOSEPH, Raspator .....                 | 101     |
| JOSEPH, Septumelevator .....           | 102     |
| JOST, Knorpelquetscher .....           | 133     |

**K**

|                                    |         |
|------------------------------------|---------|
| KASDEN, Wundhaken .....            | 73      |
| KAYE, Blepharoplastik-Schere ..... | 32      |
| KAYE, Face-Lift-Schere .....       | 31      |
| KELLY, Arterienklemme .....        | 61      |
| KELLY, Präparierschere .....       | 19      |
| KELLY-RANKIN, Arterienklemme ..... | 61      |
| KILLIAN, Hohlmeißel .....          | 130     |
| KILLIAN, Nasenspekula .....        | 113-114 |

|   |         |
|---|---------|
| KILLIAN, Septumelevator .....                   | 103-104 |
| KILLIAN-CLAUS,<br>Septumhohlmeißel .....        | 132     |
| KILNER, Nasenhaken .....                        | 88      |
| KILNER, Präparierschere .....                   | 19      |
| KILNER-DOUGHTY, Mundsperrerr .....              | 143     |
| KILNER-DOUGHTY, Zungenspatel .....              | 143     |
| KLAPP, Wundhaken .....                          | 72      |
| KLEINERT-KUTZ, Hauthäkchen .....                | 70      |
| KNAPP, Schere .....                             | 21      |
| KNAPP, Tränensackhäkchen .....                  | 86      |
| KNIGHT, Septumzange .....                       | 118     |
| Knochensplitterzange, BÖHLER .....              | 99      |
| Knochensplitterzange,<br>COTTLE-KAZANJIAN ..... | 99      |
| Knochensplitterzange, McINDOE .....             | 99      |
| Knorpelquetscher, COTTLE .....                  | 133     |
| Knorpelquetscher, JOST .....                    | 133     |
| Knorpelschere, McINDOE .....                    | 29      |
| Knüpfpinzette, Mikro .....                      | 47      |

**L**

|   |         |
|---|---------|
| LA GRANGE, Zahnfleischschere .....      | 26      |
| LAHEY, Wundhäkchen .....                | 70      |
| LANDOLT, Skalpellgriff .....            | 12      |
| LANGE, Nasenflügelhäkchen .....         | 89      |
| LANGENBECK, Endo-Dissektor .....        | 77      |
| LANGENBECK, Raspator .....              | 101     |
| LERCHE, Pinzette .....                  | 41      |
| LERICHE, Arterienklemme .....           | 63      |
| LEXER BABY, Präparierschere .....       | 15      |
| LEXER, Präparierschere .....            | 15      |
| Lidplatte, JAEGER .....                 | 58      |
| Liposuction-Kanülen .....               | 159-163 |
| LITTAUER, Fadenschere .....             | 28      |
| LITTLER, Schere .....                   | 22      |
| LOCKWOOD, Brustdissektor .....          | 82      |
| LOCKWOOD, Markierungsinstrument .....   | 3       |
| LUBET-BARBON,<br>Nasentamponzange ..... | 117     |
| LUC, Septumzange .....                  | 119     |
| LUCAE, Ohrpinzette .....                | 57      |

**M**

|  |     |
|--|-----|
| MacCOLLUM-DINGMAN,<br>Brustdissektor ..... | 81  |
| MALINIAC, Nasenhaken .....                 | 87  |
| MALTZ (COTTLE), Nasenraspel .....          | 135 |
| MALTZ, Nasenraspel .....                   | 134 |

|   |         |
|---|---------|
| Markierungsinstrument, ACKERMANN .....                | 5       |
| Markierungsinstrument,<br>D'ASSUMPCAO .....           | 3       |
| Markierungsinstrument, FREEMAN .....                  | 4       |
| Markierungsinstrument, GROSSMAN .....                 | 4       |
| Markierungsinstrument, HALPREN .....                  | 5       |
| Markierungsinstrument, LOCKWOOD .....                 | 3       |
| Markierungsinstrument, McKISSOCK .....                | 5       |
| Markierungsinstrument, PITANGUY .....                 | 3       |
| MARTINEZ-KILNER, Wundhaken .....                      | 89      |
| MARYLAND, Faßzange<br>für plastische Endoskopie ..... | 157     |
| MASING, Elevator .....                                | 102     |
| MASING-NEIVERT, Nasenhaken .....                      | 87      |
| Maßstab, Metall .....                                 | 2       |
| MAYO, Präparierschere .....                           | 13      |
| MAYO-HABERISSER,<br>TC-Drahtzange .....               | 97      |
| MAYO-HEGAR, Nadelhalter .....                         | 92      |
| MAYO-STILLE, Präparierschere .....                    | 14      |
| McINDOE, Knochensplitterzange .....                   | 99      |
| McINDOE, Knorpelschere .....                          | 29      |
| McINDOE, Pinzetten .....                              | 42      |
| McIVOR, Mundsperrerr .....                            | 144     |
| McIVOR, Bügel .....                                   | 144     |
| McIVOR, Zungenspatel .....                            | 144     |
| McKENTY, Septumelevator .....                         | 102-103 |
| McKISSOCK,<br>Markierungsinstrument .....             | 5       |
| MEAD, Hammer .....                                    | 100     |
| Meißel, CINELLI .....                                 | 127     |
| Meißel, COTTLE .....                                  | 129     |
| Meißel, FREER .....                                   | 128     |
| Meißel, KILLIAN .....                                 | 130     |
| Meißel, MINI-LAMBOTTE .....                           | 132     |
| Meißel, SILVER .....                                  | 130     |
| Meßinstrument, CASTROVIEJO .....                      | 5-6     |
| Meßinstrument, COLLIER .....                          | 5       |
| Meßzirkel, CASTROVIEJO .....                          | 5       |
| Metallmaßstab .....                                   | 2       |
| METZENBAUM, Präparierschere .....                     | 16-17   |
| METZENBAUM, Schere<br>für plastische Endoskopie ..... | 156     |
| METZENBAUM-FINO,<br>Präparierschere .....             | 17      |
| MEYERDING, Wundhaken .....                            | 74      |
| Micro HARTMANN, Arterienklemme .....                  | 59      |
| MICROVASCULAR, Nadelhalter .....                      | 93      |
| MIDDLETON-JANSEN,<br>Septumzange .....                | 123     |



|                                       |                                    |                                    |
|---------------------------------------|------------------------------------|------------------------------------|
| Pinzette, GRAEFE.....41, 52           | Rasierklingen, unsteril.....7      | Schere, FOMON.....27               |
| Pinzette, GREEN.....56                | Raspator, DINGMANN.....150         | Schere, GOLDMAN-FOX.....29         |
| Pinzette, JANSEN-GRUENWALD.....57     | Raspator, FOMON.....101            | Schere, GORNEY.....30              |
| Pinzette, LERCHE.....41               | Raspator, JOSEPH.....101           | Schere, GORNEY-FREEMAN.....30      |
| Pinzette, LUCAE.....57                | Raspator, LANGENBECK.....101       | Schere, GRADLE.....23              |
| Pinzette, McINDOE.....42              | Raspator, OBWEGESER.....149        | Schere, GRAEFE.....22              |
| Pinzette, MOD. BONN.....54            | Raspator, WILLIGER.....101         | Schere, GREENBERG-PAR.....32       |
| Pinzette, MOD. TUEBINGEN.....54       | Raspatorium, Gaumenspalter.....105 | Schere, HEYMANN.....27             |
| Pinzette, OCHSNER.....45              | Raspel, AUFRICHT.....135           | Schere, IRIS.....20                |
| Pinzette, OEHLER.....37               | Raspel, DINGMAN.....138            | Schere, JAMESON.....19             |
| Pinzette, POTTS-SMITH.....36          | Raspel, FOMON.....136-137          | Schere, JOSEPH.....18              |
| Pinzette, RUSS. MODELL.....42         | Raspel, JOSEPH (LEWIS).....135     | Schere, KAYE.....31-32             |
| Pinzette, SEMKEN.....43               | Raspel, MALTZ (COTTLE).....135     | Schere, KELLY.....19               |
| Pinzette, SINGLEY.....45              | Raspel, PARKES.....134             | Schere, KILNER.....19              |
| Pinzette, STILLE.....36-37            | Raspel, PEET.....134               | Schere, KNAPP.....21               |
| Pinzette, STILLE-BARRAYA.....45       | Raspel, WIENER.....134             | Schere, LA GRANGE.....26           |
| Pinzette, TAYLOR.....44               | REDA, Hauthäkchen.....72           | Schere, LEXER.....15               |
| Pinzette, TROELTSCH.....57            | REDA, Nasenspekula.....112         | Schere, LEXER BABY.....15          |
| Pinzette, USA.....36-37               | REDA, Sichelmesser.....125         | Schere, LITTAUER.....28            |
| Pinzette, WAUGH.....41                | REYNOLDS, Präparierschere.....19   | Schere, LITTLER.....22             |
| Pinzette, WILDE (TROELTSCH).....57    | REYNOLDS, (Transauxillary)         | Schere, MAYO.....13                |
| PITANGUY, Markierungsinstrument.....3 | Brustdissektoren.....81-82         | Schere, MAYO-STILLE.....14         |
| Polypenzange, HARTMANN.....117        | RIBBON, Darmspatel.....66          | Schere, McINDOE.....29             |
| Polypenzange, HEYMANN-KNIGHT.....118  | Ringpinzette, Mikro.....49         | Schere, METZENBAUM.....16-17       |
| POTTS-SMITH, Pinzette.....36          | ROCHESTER-OCHSNER,                 | Schere, METZENBAUM-FINO.....17     |
| Präparierschere, JAMESON.....19       | Arterienklemme.....63              | Schere, Mikro.....33-35            |
| Präparierschere, JOSEPH.....18        | ROCHESTER-PEAN,                    | Schere, O'BRIEN.....28             |
| Präparierschere, KELLY.....19         | Arterienklemme.....63              | Schere, Ophtalmologie.....23       |
| Präparierschere, KILNER.....19        | ROLLET, Tränensackhäkchen.....86   | Schere, PECK-JOSEPH.....31         |
| Präparierschere, LEXER.....15         | ROUX MINI, Wundhaken.....65        | Schere, RAGNELL.....19             |
| Präparierschere, LEXER BABY.....15    | RUBIN, Osteotom.....129            | Schere, REYNOLDS.....19            |
| Präparierschere, MAYO.....13          | RUBIN, Septumzange.....122         | Schere, SANVENERO.....18           |
| Präparierschere, MAYO-STILLE.....14   | RUSS. MODELL, Faßpinzette.....42   | Schere, SPENCER.....28             |
| Präparierschere, METZENBAUM.....16-17 | RUSSEL-DAVIS, Zungenspatel.....145 | Schere, STEVENS.....24             |
| Präparierschere,                      | RYDER, Nadelhalter.....93          | Schere, STRABISMUS.....24          |
| METZENBAUM FINO.....17                |                                    | Schere, WAGNER.....25              |
| Präparierschere, RAGNELL.....19       |                                    | SCHINK, Dermatome.....6            |
| Präparierschere, REYNOLDS.....19      |                                    | SCHMEDEN, Nasenzange.....121       |
| Präparierschere, SANVENERO.....18     |                                    | SCHWINGMESSER, BALLENGER.....126   |
| PROVIDENCE-HOSPITAL,                  |                                    | SCULPO Wundhaken mit Schaft        |
| Arterienklemme.....61                 |                                    | f. Endoskopie.....79               |
|                                       |                                    | SEMKEN, Pinzetten.....43           |
|                                       |                                    | Septumelevator, BALLENGER.....104  |
|                                       |                                    | Septumelevator, COTTLE.....103-104 |
|                                       |                                    | Septumelevator,                    |
|                                       |                                    | COTTLE-JOSEPH.....103              |
|                                       |                                    | Septumelevator, FREER.....102      |
|                                       |                                    | Septumelevator,                    |
|                                       |                                    | HAJEK-BALLENGER.....104            |
|                                       |                                    | Septumelevator, HOWARTH.....103    |
|                                       |                                    | Septumelevator, JOSEPH.....102     |

**Q**

QUISLING, Hammer.....100

**R**

 RAGNELL, Präparierschere.....19  
 RAGNELL, Wundhaken.....65  
 RAMUS, Wundhaken.....148

**S**

|   |
|---|
| SANVENERO, Präparierschere.....18       |
| Saugraspatorium, GUILLEN.....109        |
| Saugrohr, ADSON.....107                 |
| Saugrohr, BARON.....107                 |
| Saugrohr, FRAZIER/FERGUSSON...108       |
| Schaft f. plastische Endoskopie.....80, |
| .....153-155                            |
| Schere f. plastische Endoskopie.....156 |
| Schere, BEUSE.....31                    |
| Schere, BONN.....20                     |
| Schere, CHADWICK.....26                 |
| Schere, CONVERSE/WILMER.....22          |
| Schere, COTTLE.....22, 27               |
| Schere, COTTLE-MASING.....27            |

|  |         |
|--|---------|
| Septumelevator, KILLIAN .....          | 103-104 |
| Septumelevator, McKENTY .....          | 102-103 |
| Septumelevator, PENNINGTON .....       | 103     |
| Septumelevator, PIERCE .....           | 103     |
| Septumelevator, SINUS .....            | 103     |
| Septumhohlmeißel, FOMON .....          | 127     |
| Septumhohlmeißel, FREER .....          | 132     |
| Septumhohlmeißel, HAJEK .....          | 132     |
| Septumhohlmeißel, KILLIAN-CLAUS .....  | 132     |
| Septummeißel, CINELLI .....            | 127     |
| Septummeißel, COTTLE .....             | 129     |
| Septummeißel, FREER .....              | 128     |
| Septummeißel, SHEEHAN .....            | 127     |
| Septummeißel, SILVER .....             | 130     |
| Septumosteotom, COTTLE .....           | 129     |
| Septumrichtzange, ASCH .....           | 140     |
| Septumrichtzange, WALSHAM .....        | 140     |
| Septumzange, BRUENINGS .....           | 119     |
| Septumzange, CRAIG .....               | 119     |
| Septumzange, KNIGHT .....              | 118     |
| Septumzange, LUC .....                 | 119     |
| Septumzange,<br>MIDDLETON-JANSEN ..... | 123     |
| Septumzange, RUBIN .....               | 122     |
| Sichelmesser, REDA .....               | 125     |
| Silikon-Schlauch .....                 | 144     |
| SILVER, Dermatome .....                | 7       |
| SILVER, Septummeißel .....             | 130     |
| SILVERSTEIN, Brustdissektor .....      | 82      |
| SINGLEY, Gewebefußpinzette .....       | 45      |
| SINUS, Septumelevator .....            | 103     |
| Skalpelli, LANDOLT .....               | 12      |
| Skalpelli, Mini .....                  | 11      |
| Skalpelli, Klinge, Mini .....          | 11      |
| Spannplatte .....                      | 6       |
| Spatel .....                           | 80      |
| Spatel-Elektrode, monopolar .....      | 158     |
| SPENCER, Fadenschere .....             | 28      |
| Sperrer, DAVIS-BOYLE .....             | 142     |
| Sperrer, DINGMANN .....                | 143     |
| Sperrer, KILNER-DOUGHTY .....          | 143     |
| SPINA-NASALIS, Wundhaken .....         | 148     |
| Splitterpinzetten .....                | 46      |
| Stahlhammer, COTTLE .....              | 100     |
| STEVENS, Schere .....                  | 24      |
| STILLE, Pinzette .....                 | 36-37   |
| STILLE-BARRAYA, Gefäßpinzette .....    | 45      |
| STRABISMUS, Schere .....               | 24      |
| STRANDELL-STILLE, Wundhaken .....      | 74      |

## T

|   |       |
|---|-------|
| TAKAHASHI, Nasenzange .....             | 121   |
| Tamponzange, LUBET-BARBON .....         | 117   |
| Tamponzange, WESTMACOTT .....           | 117   |
| TAYLOR, Pinzette .....                  | 44    |
| TC-Drahtzange, BERRY .....              | 97    |
| TC-Drahtzange,<br>MAYO-HABERISSER ..... | 97    |
| TC-Nasenraspel, FOMON .....             | 137   |
| TC-Nasenraspel, MALTZ (COTTLE) .....    | 135   |
| TEBBETTS, Brustdissektor .....          | 81    |
| TEBBETTS, Wundhaken .....               | 78    |
| TESSIER, Mobilisierhaken .....          | 150   |
| TESSIER, Osteotom .....                 | 151   |
| TEICK-HALLE, Nasenspekula .....         | 112   |
| Titan Mikro Nadelhalter .....           | 95-96 |
| Trachealhaken, JACKSON .....            | 90    |
| Trachealhaken, NEWS .....               | 90    |
| Tränensackhäkchen, KNAPP .....          | 86    |
| Tränensackhäkchen, ROLLET .....         | 86    |
| TROELTSCH, Ohrpinzette .....            | 57    |
| TYRELL, Hauthäkchen .....               | 69    |

## U

|                         |       |
|-------------------------|-------|
| Uhrmacherpinzette ..... | 46    |
| USA, Pinzette .....     | 36-37 |

## V

|                           |    |
|---------------------------|----|
| VOLKMANN, Wundhaken ..... | 73 |
|---------------------------|----|

## W

|   |     |
|---|-----|
| WAGNER, Schere .....                    | 25  |
| WALSHAM, Septumrichtzange .....         | 140 |
| WALTER/CONVERSE/WILMER,<br>Schere ..... | 22  |
| WATSON, Dermatome .....                 | 7   |
| WAUGH, Pinzette .....                   | 41  |
| WEBSTER, Nadelhalter .....              | 91  |
| WEIL-BLAKESLEY, Nasenzange .....        | 120 |
| WEITLANER, Wundsprerrer .....           | 76  |
| WEST, Hohlmeißel .....                  | 132 |
| WEST, Osteotom .....                    | 132 |
| WESTMACOTT,<br>Nasentamponzange .....   | 117 |
| WIEDER, Zungenspatel .....              | 141 |
| WIENER, Antrumraspel .....              | 134 |
| WIENER, Irishhäkchen .....              | 86  |
| WILDE (TROELTSCH), Ohrpinzette .....    | 57  |

|   |         |
|---|---------|
| WILLIGER, Raspator .....                            | 101     |
| WILMER/CONVERSE/WALTER,<br>Schere .....             | 22      |
| Winkelmesser, MOELTGEN .....                        | 2       |
| Wundhäkchen, BARSKY .....                           | 71      |
| Wundhäkchen, COTTLE .....                           | 88-89   |
| Wundhäkchen, COTTLE-NEIVERT .....                   | 88      |
| Wundhäkchen, FOMON .....                            | 88      |
| Wundhäkchen, FREER .....                            | 88      |
| Wundhäkchen, GILLIES .....                          | 89      |
| Wundhäkchen, HUMBY .....                            | 71      |
| Wundhäkchen, KNAPP .....                            | 86      |
| Wundhäkchen, LAHEY .....                            | 70      |
| Wundhäkchen, MILLER .....                           | 86      |
| Wundhäkchen, O'CONNOR .....                         | 86      |
| Wundhäkchen, ROLLET .....                           | 86      |
| Wundhäkchen, WIENER .....                           | 86      |
| Wundhaken .....                                     | 150     |
| Wundhaken für plastische<br>Chirurgie .....         | 78-81   |
| Wundhaken mit Schaft f.<br>Endoskopie, SCULPO ..... | 79      |
| Wundhaken, ALM .....                                | 75      |
| Wundhaken, ANDERSON .....                           | 84      |
| Wundhaken, BIGGS .....                              | 79      |
| Wundhaken, BREAST .....                             | 80      |
| Wundhaken, CORONAL .....                            | 84      |
| Wundhaken, CRILE .....                              | 65      |
| Wundhaken, DEEVER .....                             | 67-68   |
| Wundhaken, DESMARRES .....                          | 73      |
| Wundhaken, FARABEUF .....                           | 65      |
| Wundhaken, FERRIERA .....                           | 78      |
| Wundhaken, FINSSEN .....                            | 75      |
| Wundhaken, FREEMAN .....                            | 68, 84  |
| Wundhaken, GORNEY .....                             | 84      |
| Wundhaken, KASDEN .....                             | 73      |
| Wundhaken, KLAPP .....                              | 72      |
| Wundhaken, MARTINEZ-KILNER .....                    | 89      |
| Wundhaken, MEYERDING .....                          | 74      |
| Wundhaken, OBWEGESER .....                          | 146-148 |
| Wundhaken, RAGNELL .....                            | 65      |
| Wundhaken, RAMUS .....                              | 148     |
| Wundhaken, ROUX MINI .....                          | 65      |
| Wundhaken, SPINA-NASALIS .....                      | 148     |
| Wundhaken, STRANDELL-STILLE .....                   | 74      |
| Wundhaken, TEBBETTS .....                           | 78      |
| Wundhaken, VOLKMANN .....                           | 73      |
| Wundhaken, YANCOSKIE .....                          | 83      |
| Wundsperrer, HOLZHEIMER .....                       | 75      |
| Wundsperrer, JANSEN .....                           | 75      |
| Wundsperrer, WEITLANER .....                        | 76      |

**Y**

YANCOSKIE, Wundhaken.....83

**Z**

Zahnfleischschere, CHADWICK.....26

Zahnfleischschere,

GOLDMAN-FOX.....29

Zahnfleischschere, LA GRANGE.....26

Zungenspatel, ANDREW.....141

Zungenspatel, DAVIS-BOYLE.....142

Zungenspatel, DINGMANN.....143

Zungenspatel, KILNER-DOUGHTY...143

Zungenspatel, McIVOR.....144

Zungenspatel, RUSSEL-DAVIS.....145

Zungenspatel, WIEDER.....141



**A**

ACKERMANN marker .....5  
 ADSON, dressing forceps .....38  
 ADSON, forceps .....64  
 ADSON, hook .....85  
 ADSON, suction tube .....107  
 ADSON, tissue forceps .....38-39  
 ADSON-BROWN, tissue forceps .....40  
 ADSON-DeBAKEY, dressing forceps .....38  
 AGRIS-DINGMAN, dissector .....81  
 ALM, retractor .....75  
 ANDERSON, retractor .....84  
 ANDREW, tongue depressor .....141  
 ASCH, septum straightening forceps .....140  
 Atrauma forceps, DeBAKEY .....49-51  
 AUFRICHT, nasal rasp .....135  
 AUFRICHT, retractor .....87

**B**

BABY OLSEN-HEGAR, needle holder .....93  
 BALLENGER, elevator .....104  
 BALLENGER, knife .....126  
 BARON, suction tube .....107  
 BARRAQUER, cilia forceps .....55  
 BARRAQUER, needle holder .....95  
 BARSKY, retractor .....71  
 BAUMGARTNER, needle holder .....92  
 BEASELEY BABCOCK, Tissue forceps .....39  
 BERKE, muscle forceps .....55  
 BERRY, wire twisting forceps .....97  
 BEUSE, scissors .....31  
 BEYER, rongeur .....98  
 BIGGS, retractor .....79  
 BISHOP-HARMAN, iris forceps .....53  
 BLAIR, lip and cleft palate Instrument .....106  
 BÖHLER, bone cutting forceps .....99  
 BÖHLER, rongeur .....98  
 BOIES, elevator .....102  
 Bone cutting forceps, BÖHLER .....99  
 Bone cutting forceps, COTTLE-KAZANJIAN .....99  
 Bone cutting forceps, MC INDOE .....99  
 BONN, scissors .....20  
 BONNEY, tissue forceps .....45  
 Breast Dissectors, LOCKWOOD .....82

Breast Dissector, REYNOLDS (Transauxillary) .....81  
 BREAST, retractor .....80  
 Breast, spatula .....80  
 BROWN, tissue forceps .....41  
 BRUENINGS, septum forceps .....119

**C**

Caliper, CASTROVIEJO .....5  
 CAPLAN, nasal cutting scissors .....122  
 Cartilage crusher, COTTLE .....133  
 Cartilage crusher, JOST .....133  
 CASTROVIEJO, caliper .....5  
 CASTROVIEJO, needle holder .....96  
 CASTROVIEJO, suture forceps .....55  
 CHADWICK, scissors .....26  
 Chalazion forceps, DESMARRES .....55  
 Chisel, CINELLI .....127  
 Chisel, COTTLE .....129  
 Chisel, FREER .....128  
 Chisel, SHEEHAN .....127  
 Chisel, WEST .....132  
 Cilia forceps, BARRAQUER .....55  
 COLLER-CRILE, forceps .....61  
 COLLIER, pelvimeter .....5  
 COLLIN-DUVAL, tissue forceps .....42  
 Columella forceps, COTTLE .....57  
 CONVERSE, knife .....125  
 CONVERSE, retractor .....87  
 CONVERSE, retractor .....89  
 CONVERSE/WILMER/WALTER, Scissors .....22  
 CORONAL, retractor .....84  
 COTTLE JOSEPH, elevator .....103  
 COTTLE, cartilage crusher .....133  
 COTTLE, chisel .....129  
 COTTLE, columella forceps .....57  
 COTTLE, ear forceps .....57  
 COTTLE, elevator .....103-104  
 COTTLE, knife .....125  
 COTTLE, mallet .....100  
 COTTLE, nasal specula .....115-116  
 COTTLE, osteotome .....129  
 COTTLE, retractor .....87-89  
 COTTLE, scissors .....22, 27  
 COTTLE-KAZANJIAN, Bone Cutting forceps .....99  
 COTTLE-MASING, scissors .....27  
 COTTLE-NEIVERT, retractor .....88  
 CRAIG, septum forceps .....119  
 CRILE, forceps .....62

CRILE, hook .....85  
 CRILE, retractor .....65  
 CRILE-RANKIN, forceps .....62  
 CRILE-WOOD, needle holder .....92  
 CRONIN, lip and cleft palate instrument .....105  
 CUSHING, hook .....85  
 CUSHING, tissue forceps .....41  
 CUSHING-TAYLOR, Dressing Forceps .....44

**D**

D'ASSUMPCAO, facelift marker .....3  
 DAVIS-BOYLE, mouth gag .....142  
 DAVIS-MEYER, mouth gag .....144  
 DEAVER, retractor .....67-68  
 DeBAKEY, atrauma forceps .....49-51  
 DeBAKEY, needle holder .....92  
 DERF, needle holder .....91  
 Dermatome, HUMBLY .....7  
 Dermatome, SCHINK .....6  
 Dermatome, SILVER .....7  
 Dermatome, WATSON .....7  
 DESMARRES, chalazion forceps .....55  
 DESMARRES, retractor .....73  
 DINGMAN, nasal rasp .....138  
 DINGMANN, elevator .....150  
 DINGMANN, mouth gag .....143  
 Dissector, AGRIS-DINGMAN .....81  
 Dissector, GORNEY .....102  
 Dissector, LANGENBECK .....77  
 Dissector, LANGENBECK-COTTLE .....77  
 Dissector, MacCOLLUM-DINGMAN .....81  
 Dissector, MINI-LANGENBECK .....77  
 Dissector, SILVERSTEIN .....82  
 Dissector, TEBBETTS .....81  
 DOLPHIN, endoscopic grasper .....157  
 Dressing forceps, ADSON .....38  
 Dressing forceps, ADSON-DeBAKEY .....38  
 Dressing forceps, CUSHING-TAYLOR .....44  
 Dressing forceps, GERALD .....43-44  
 Dressing forceps, McINDOE .....42  
 Dressing forceps, OCHSNER .....45  
 Dressing forceps, POTTS-SMITH .....36  
 Dressing forceps, SEMKEN .....43  
 Dressing forceps, SINGLEY .....45  
 Dressing forceps, STILLE .....36

|                               |       |
|-------------------------------|-------|
| Dressing forceps, TAYLOR..... | 44    |
| Dressing forceps, USA.....    | 36    |
| Dressing, forceps.....        | 36-43 |
| DURANTE, tissue forceps.....  | 45    |
| DUVAL, tissue forceps.....    | 42    |

**E**

|   |                |
|---|----------------|
| Ear forceps, COTTLE.....                | 57             |
| Ear forceps,<br>JANSEN-GRUENWALD.....   | 57             |
| Ear forceps, LUCAE.....                 | 57             |
| Ear forceps, TROELTSCH.....             | 57             |
| Ear forceps, WILDE (TROELTSCH).....     | 57             |
| Ear polypus forceps, HARTMANN.....      | 117            |
| Elevator, BALLENGER.....                | 104            |
| Elevator, BOIES.....                    | 102            |
| Elevator, COTTLE.....                   | 103-104        |
| Elevator, COTTLE JOSEPH.....            | 103            |
| Elevator, DINGMANN.....                 | 150            |
| Elevator, FREER.....                    | 102            |
| Elevator, HAJEK-BALLENGER.....          | 104            |
| Elevator, HOWARTH.....                  | 103            |
| Elevator, JOSEPH.....                   | 102            |
| Elevator, KILLIAN.....                  | 103-104        |
| Elevator, LANGENBECK.....               | 101            |
| Elevator, MASING.....                   | 102            |
| Elevator, McKENTY.....                  | 102-103        |
| Elevator, OBWEGESER.....                | 149            |
| Elevator, PENNINGTON.....               | 103            |
| Elevator, PIERCE.....                   | 103            |
| Elevator, WILLIGER.....                 | 101            |
| Endoscope shaft, plastic surgery.....   | 80,<br>153-155 |
| Endoscope, plastic surgery.....         | 153            |
| Endoscopic grasper, DOLPHIN.....        | 157            |
| Endoscopic grasper, MARYLAND.....       | 157            |
| Endoscopic scissors,<br>METZENBAUM..... | 156            |
| Endoscopic, heavy grasper.....          | 157            |
| Endoscopic, hook scissors.....          | 156            |

**F**

|                                   |    |
|-----------------------------------|----|
| Facelift marker, D'ASSUMPCAO..... | 3  |
| Facelift marker, LOCKWOOD.....    | 3  |
| Facelift marker, PITANGUY.....    | 3  |
| FARABEUF, retractor.....          | 65 |
| FERRIERA, retractor.....          | 78 |
| FERRIS-SMITH, tissue forceps..... | 42 |
| Finger, goniometer.....           | 2  |

|   |         |
|---|---------|
| FINSEN, retractor.....                  | 75      |
| Fixation forceps, GREEN.....            | 56      |
| FOMON septum chisels.....               | 127     |
| FOMON, nasal rasp.....                  | 136-137 |
| FOMON, nasal rasp.....                  | 137     |
| FOMON, raspatory.....                   | 101     |
| FOMON, retractor.....                   | 88      |
| FOMON, scissors.....                    | 27      |
| Forceps, ADSON.....                     | 64      |
| Forceps, COLLER-CRILE.....              | 61      |
| Forceps, CRILE.....                     | 62      |
| Forceps, CRILE-RANKIN.....              | 62      |
| Forceps, dressing.....                  | 36-43   |
| Forceps, HALSTED-MOSQUITO.....          | 60      |
| Forceps, HARTMANN.....                  | 59      |
| Forceps, KELLY.....                     | 61      |
| Forceps, KELLY-RANKIN.....              | 61      |
| Forceps, LERICHE.....                   | 63      |
| Forceps, micro ring.....                | 48      |
| Forceps, micro suture tying.....        | 47      |
| Forceps, MICRO-HARTMANN.....            | 59      |
| Forceps, PROVIDENCE-HOSPITAL.....       | 61      |
| Forceps, ROCHESTER-OCHSNER.....         | 63      |
| Forceps, ROCHESTER-PEAN.....            | 63      |
| Forceps, splinter.....                  | 46      |
| Forceps, tissue.....                    | 36-37   |
| FRAZIER/FERGUSSON,<br>suction tube..... | 108     |
| FREEMAN, marker.....                    | 4       |
| FREEMAN, retractor.....                 | 68, 84  |
| FREER, elevator.....                    | 102     |
| FREER, gouge.....                       | 132     |
| FREER, knife.....                       | 124     |
| FREER, retractor.....                   | 88      |
| FREER, rhinoplastic chisels.....        | 128     |
| FRIEDMANN MINI, rongeur.....            | 98      |
| FRIEDMANN, rongeur.....                 | 98      |

**G**

|                               |       |
|-------------------------------|-------|
| GERALD, dressing forceps..... | 43-44 |
| GERALD, tissue forceps.....   | 44    |
| GERZOG, mallet.....           | 100   |
| GILLIES, needle holder.....   | 94    |
| GILLIES, retractor.....       | 89    |
| GILLIES, tissue forceps.....  | 43    |
| GLABELLA, nasal rasp.....     | 134   |
| GOLDMAN-FOX, scissors.....    | 29    |
| Goniometer, finger.....       | 2     |
| Goniometer, MOELTGEN.....     | 2     |

|                                    |         |
|------------------------------------|---------|
| GORNEY, dissector.....             | 102     |
| GORNEY nasal cutting scissors..... | 122     |
| GORNEY, retractor.....             | 84      |
| GORNEY, scissors.....              | 30, 122 |
| GORNEY-FREEMAN, scissors.....      | 30      |
| Gouge, FREER.....                  | 132     |
| Gouge, HAJEK.....                  | 132     |
| Gouge, KILLIAN.....                | 130     |
| Gouge, KILLIAN-KLAUS.....          | 132     |
| Gouge, WEST.....                   | 132     |
| GRADLE, scissors.....              | 23      |
| GRAEFE, iris forceps.....          | 52      |
| GRAEFE, retractor.....             | 69      |
| GRAEFE, scissors.....              | 22      |
| GRAEFE, tissue forceps.....        | 41      |
| GREEN, fixation forceps.....       | 56      |
| GREENBERG-PAR, scissors.....       | 32      |
| GROSSMAN, marker.....              | 4       |
| GUILLEN, suction tube.....         | 109     |
| GUTHRIE, retractor.....            | 69      |

**H**

|                                    |      |
|------------------------------------|------|
| HAJEK, gouge.....                  | 132  |
| HAJEK-BALLENGER, elevator.....     | 104  |
| HALPREN marker.....                | 5    |
| HALSEY, needle holder.....         | 91   |
| HALSTED-MOSQUITO, forceps.....     | 60   |
| Handles, scalpel.....              | 8-12 |
| HARTMANN, ear polypus forceps..... | 117  |
| HARTMANN, forceps.....             | 59   |
| HARTMANN, nasal specula.....       | 111  |
| HARTMANN-HALLE, nasal specula..... | 110  |
| Heavy grasper, endoscopic.....     | 157  |
| HEYMAN, scissors.....              | 27   |
| HEYMANN-KNIGHT, nasal forceps..... | 118  |
| HOLZHEIMER, retractor.....         | 75   |
| Hook scissors, endoscopic.....     | 156  |
| Hook, ADSON.....                   | 85   |
| Hook, CRILE.....                   | 85   |
| Hook, CUSHING.....                 | 85   |
| Hook, JACKSON.....                 | 90   |
| Hook, nerve.....                   | 77   |
| Hook, NEWS.....                    | 90   |
| Hook, thimble, MILLARD.....        | 84   |
| HOWARTH, elevator.....             | 103  |
| HUMBY, dermatome.....              | 7    |
| HUMBY, retractor.....              | 71   |

## I

|                                  |    |
|----------------------------------|----|
| Iris forceps, BISHOP-HARMAN..... | 53 |
| Iris forceps, GRAEFE .....       | 52 |
| IRIS, scissors.....              | 20 |

## J

|                                    |         |
|------------------------------------|---------|
| JACKSON, hook.....                 | 90      |
| JAEGER, lid plate.....             | 58      |
| JANSEN, retractor.....             | 75      |
| JANSEN-GRUENWALD, ear forceps..... | 57      |
| JENNINGS, tongue depressor .....   | 141     |
| J-Hook electrode, monopolar .....  | 158     |
| JOSEPH (LEWIS), nasal rasp .....   | 135     |
| JOSEPH, elevator .....             | 102     |
| JOSEPH, knife.....                 | 124-125 |
| JOSEPH, nasal rasp.....            | 134     |
| JOSEPH, nasal saw .....            | 138-139 |
| JOSEPH, raspatory .....            | 101     |
| JOSEPH, retractor.....             | 70      |
| JOSEPH, scissors .....             | 18      |
| JOST, cartilage crusher .....      | 133     |

## K

|                                |         |
|--------------------------------|---------|
| KASDAN, retractor .....        | 73      |
| KAYE, scissors .....           | 21, 32  |
| KELLY, forceps .....           | 61      |
| KELLY, scissors .....          | 19      |
| KELLY-RANKIN, forceps .....    | 61      |
| KILLIAN, elevator .....        | 103-104 |
| KILLIAN, gouge .....           | 130     |
| KILLIAN, nasal specula .....   | 113-114 |
| KILLIAN-KLAUS, gouge .....     | 132     |
| KILNER, retractor .....        | 88      |
| KILNER, scissors.....          | 19      |
| KILNER-DOUGHTY, mouth gag..... | 143     |
| KLAPP, retractor.....          | 72      |
| KLEINERT-KUTZ, retractor ..... | 70      |
| KNAPP, retractor .....         | 86      |
| KNAPP, scissors.....           | 21      |
| Knife, BALLENGER.....          | 126     |
| Knife, CONVERSE .....          | 125     |
| Knife, COTTLE .....            | 125     |
| Knife, FREER .....             | 124     |
| Knife, JOSEPH.....             | 124-125 |
| Knife, REDA.....               | 125     |
| KNIGHT, nasal forceps.....     | 118     |

## L

|                          |    |
|--------------------------|----|
| LA GRANGE, scissors..... | 26 |
|--------------------------|----|

|   |         |
|---|---------|
| LAHEY, retractor.....   | 70      |
| LANGE, retractor.....   | 89      |
| LANGENBECK, dissector.....  | 77      |
| LANGENBECK, elevator .....  | 101     |
| LANGENBECK-COTTLE,<br>dissector .....   | 77      |
| LERCHE, tissue forceps.....   | 41      |
| LERICHE, forceps .....  | 63      |
| LEXER, scissors.....  | 15      |
| LEXER-BABY, scissors .....  | 15      |
| Liposuction cannulas .....  | 159-163 |
| Lid plate, JAEGER.....  | 58      |
| Lip and cleft palate instrument,<br>Lip and cleft palate instrument,<br>BLAIR ..... | 105     |
| Lip and cleft palate instrument,<br>BLAIR .....                                     | 106     |
| Lip and cleft palate instrument,<br>CRONIN .....                                    | 105     |
| LITTAUER, scissors .....  | 28      |
| LITTLER, scissors .....   | 22      |
| LOCKWOOD, Breast Dissector.....   | 82      |
| LOCKWOOD, facelift marker.....  | 3       |
| LUBET-BARBON, nasal forceps .....   | 117     |
| LUC, septum forceps.....  | 119     |
| LUCAE, ear forceps.....   | 57      |

## M

|  |     |
|--|-----|
| MacCOLLUM-DINGMAN,<br>dissector .....          | 81  |
| MALINIAC, retractor .....                      | 87  |
| Mallet, COTTLE.....                            | 100 |
| Mallet, GERZOG .....                           | 100 |
| Mallet, MEAD.....                              | 100 |
| Mallet, nylon cap.....                         | 100 |
| Mallet, PARTSCH.....                           | 100 |
| Mallet, QUISLING.....                          | 100 |
| MALTZ (COTTLE), nasal rasp.....                | 135 |
| MALTZ, nasal rasp .....                        | 134 |
| Marker, ACKERMANN .....                        | 5   |
| Marker, FREEMAN.....                           | 4   |
| Marker, GROSSMAN.....                          | 4   |
| Marker, HALPREN.....                           | 5   |
| Marker, McKISSOCK.....                         | 5   |
| MARYLAND, endoscopic grasper .....             | 157 |
| MASING, elevator.....                          | 102 |
| MASING-NEIVERT, retractor.....                 | 87  |
| MAYO, scissors .....                           | 13  |
| MAYO-HABERISSER, wire twisting<br>forceps..... | 97  |
| MAYO-HEGAR, needle holder .....                | 92  |
| MAYO-STILLE, scissors .....                    | 14  |
| MC INDOE, bone cutting forceps .....           | 99  |

|   |         |
|---|---------|
| MC INDOE, scissors.....                   | 29      |
| McINDOE, dressing forceps .....           | 42      |
| McINDOE, tissue forceps .....             | 42      |
| McIVOR, mouth gag.....                    | 144     |
| McKENTY, elevator .....                   | 102-103 |
| McKISSOCK, marker.....                    | 5       |
| MEAD, mallet.....                         | 100     |
| Metal, ruler.....                         | 2       |
| METZENBAUM, Endoscopic<br>Scissors .....  | 156     |
| METZENBAUM, scissors .....                | 16-17   |
| METZENBAUM-FINO, scissors.....            | 17      |
| MEYERDING, retractor .....                | 74      |
| Micro ring, forceps .....                 | 48      |
| Micro suture tying, forceps .....         | 47      |
| Micro, scissors.....                      | 33-35   |
| MICRO-HARTMANN, forceps .....             | 59      |
| MICROVASCULAR, needle holder.....         | 93      |
| MIDDLETON-JANSEN,<br>septum forceps ..... | 123     |
| MILLARD thimble hook.....                 | 84      |
| MILLER, retractor .....                   | 86      |
| MINI-LAMBOTTE, osteotome.....             | 132     |
| MINI-LANGENBECK, dissector.....           | 77      |
| MOD. BONN, suture forceps .....           | 54      |
| MOD. TUEBINGEN, suture forceps .....      | 54      |
| Mod. WIEN, nasal specula .....            | 112     |
| MOELTGEN, goniometer.....                 | 2       |
| Monopolar, J-Hook electrode.....          | 158     |
| Monopolar, Spatula electrode.....         | 158     |
| Mouth gag, DAVIS-BOYLE .....              | 142     |
| Mouth gag, DAVIS-MEYER.....               | 144     |
| Mouth gag, DINGMANN.....                  | 143     |
| Mouth gag, KILNER-DOUGHTY .....           | 143     |
| Mouth gag, McIVOR.....                    | 144     |
| Muscle forceps, BERKE .....               | 55      |
| MYLES, nasal cutting forceps .....        | 121     |

## N

|  |     |
|--|-----|
| Nasal cutting scissors, CAPLAN .....           | 122 |
| Nasal cutting scissors, GORNEY .....           | 122 |
| Nasal cutting forceps, MYLES.....              | 121 |
| Nasal cutting forceps,<br>SCHMEDEN .....       | 121 |
| Nasal cutting forceps,<br>TAKAHASHI .....      | 121 |
| Nasal cutting forceps,<br>WEIL-BLAKESLEY ..... | 120 |
| Nasal forceps, HEYMANN-KNIGHT .....            | 118 |
| Nasal forceps, KNIGHT .....                    | 118 |
| Nasal forceps, LUBET-BARBON.....               | 117 |



REYNOLDS (Transauxillary),  
 Breast Dissectors ..... 81-82  
 RIBBON, retractor .....66  
 ROCHESTER-OCHSNER, forceps .....63  
 ROCHESTER-PEAN, forceps .....63  
 ROLLET, retractor.....86  
 Rongeur, BEYER.....98  
 Rongeur, BÖHLER.....98  
 Rongeur, FRIEDMANN.....98  
 Rongeur, FRIEDMANN MINI.....98  
 ROUX, retractor.....65  
 RUBIN, osteotome.....129  
 RUBIN, septum forceps.....122  
 Ruler, metal .....2  
 RUSSEL-DAVIS , tongue depressor .....  
 .....145  
 RUSSIAN PATTERN, tissue forceps .....  
 .....42  
 RYDER, needle holder .....93

**S**

SANVENERO, scissors .....18  
 Scalpel, handles ..... 8-12  
 SCHINK, dermatome.....6  
 SCHMEDEN, nasal cutting forceps.....  
 .....121  
 Scissors, BEUSE.....31  
 Scissors, BONN.....20  
 Scissors, CHADWICK .....26  
 Scissors, CONVERSE/WILMER/  
 WALTER.....22  
 Scissors, COTTLE.....22, 27  
 Scissors, COTTLE-MASING .....27  
 Scissors, FOMON.....27  
 Scissors, GOLDMAN-FOX .....29  
 Scissors, GORNEY .....30, 122  
 Scissors, GORNEY-FREEMAN .....30  
 Scissors, GRADLE .....23  
 Scissors, GRAEFE .....22  
 Scissors, GREENBERG-PAR.....32  
 Scissors, HEYMAN.....27  
 Scissors, IRIS .....20  
 Scissors, JOSEPH.....18  
 Scissors, KAYE.....33-32  
 Scissors, KELLY .....19  
 Scissors, KILNER .....19  
 Scissors, KNAPP .....21  
 Scissors, LA GRANGE .....26  
 Scissors, LEXER .....15  
 Scissors, LEXER-BABY .....15  
 Scissors, LITTAUER.....28

Scissors, LITTLER.....22  
 Scissors, MAYO.....13  
 Scissors, MAYO-STILLE .....14  
 Scissors, MC INDOE .....29  
 Scissors, METZENBAUM.....16-17  
 Scissors, METZENBAUM-FINO .....17  
 Scissors, micro .....33-35  
 Scissors, O'BRIEN .....28  
 Scissors, PECK-JOSEPH.....31  
 Scissors, REYNOLDS .....19  
 Scissors, SANVENERO .....18  
 Scissors, SPENCER .....28  
 Scissors, STEVENS .....24  
 Scissors, STRABISMUS.....24  
 Scissors, WAGNER.....25  
 Scissors, WILMER/CONVERSE .....22  
 SCULPO retractor with  
 Endoscope shaft.....79  
 SEMKEN, dressing forceps .....43  
 SEMKEN, tissue forceps .....43  
 septum chisels, CINELLI .....127  
 septum chisels, FOMON .....127  
 Septum forceps, BRUENINGS .....119  
 Septum forceps, CRAIG .....119  
 Septum forceps, LUC .....119  
 Septum forceps,  
 MIDDLETON-JANSEN .....123  
 Septum forceps, RUBIN .....122  
 Septum straightening forceps,ASCH.....  
 .....140  
 Septum straightening forceps,  
 WALSHAM .....140  
 SHEEHAN, Osteotom.....127  
 SILVER, dermatome .....7  
 SILVER, osteotome .....130  
 SILVERSTEIN, dissector .....82  
 SINGLEY, dressing forceps .....45  
 SINUS, probe .....103  
 Skin plate for dermatomes .....6  
 Spare blades for dermatomes .....6-7  
 Spatula electrode, monopolar.....158  
 Spatula, breast .....80  
 SPENCER, scissors .....28  
 SPINA-NASALIS, retractor .....148  
 Splinter, forceps.....46  
 STEVENS, scissors.....24  
 STILLE, dressing forceps .....36  
 STILLE, tissue forceps .....37  
 STILLE-BARRAYA, tissue forceps .....45  
 STRABISMUS, scissors .....24  
 STRANDELL-STILLE, retractor.....74

Suction tube, ADSON .....107  
 Suction tube, BARON .....107  
 Suction tube,  
 FRAZIER/FERGUSON .....108  
 Suction tube, GUILLEN.....109  
 Suture forceps, CASTROVIEJO.....55  
 Suture forceps, MOD. BONN .....54  
 Suture forceps, MOD. TUEBINGEN...54

**T**

TAKAHASHI, nasal cutting  
 forceps .....121  
 TAYLOR, dressing forceps .....44  
 TAYLOR, tissue forceps .....44  
 TEBBETS, retractor.....78  
 TEBBETS, dissector.....81  
 TESSIER, osteotome .....151  
 TESSIER, raspatory .....150  
 TIECK-HALLE, nasal specula .....112  
 Tissue forceps, ADSON.....38-39  
 Tissue forceps, ADSON-BROWN.....40  
 Tissue forceps,  
 BEASELEY BABCOCK .....39  
 Tissue forceps, BONNEY .....45  
 Tissue forceps, BROWN .....41  
 Tissue forceps, COLLIN-DUVAL .....42  
 Tissue forceps, CUSHING.....41  
 Tissue forceps, DURANTE .....45  
 Tissue forceps, DUVAL.....42  
 Tissue forceps, FERRIS-SMITH.....42  
 Tissue forceps, GERALD .....44  
 Tissue forceps, GILLIES.....43  
 Tissue forceps, GRAEFE .....41  
 Tissue forceps, LERCHE.....41  
 Tissue forceps, McINDOE .....42  
 Tissue forceps, OEHLER .....37  
 Tissue forceps, POTTS-SMITH.....36  
 Tissue forceps, RUSSIAN PATTERN.....  
 .....42  
 Tissue forceps, SEMKEN .....43  
 Tissue forceps, STILLE .....37  
 Tissue forceps, STILLE-BARRAYA.....45  
 Tissue forceps, TAYLOR .....44  
 Tissue forceps, USA.....37  
 Tissue forceps, WAUGH.....41  
 Tissue, forceps .....36-37  
 Tongue depressor, ANDREW .....141  
 Tongue depressor, JENNINGS.....141  
 Tongue depressor, RUSSEL-DAVIS  
 .....145  
 Tongue depressor, WIEDER.....141

TROELTSCH, ear forceps .....57  
TYRELL, retractor.....69

**U**

USA, dressing forceps.....36  
USA, tissue forceps.....37

**V**

VOLKMANN, retractor .....73

**W**

WAGNER, scissors .....25  
WALSHAM, septum straightening  
forceps..... 140  
WALTER/CONVERSE/WILMER,  
scissors.....22  
WATSON, dermatome .....7  
WAUGH, tissue forceps.....41  
WEBSTER, needle holder .....91  
WEIL-BLAKESLEY, Nasal Cutting  
forceps..... 120  
WEITLANER, retractor .....76  
WEST, chisel .....132  
WEST, gouge.....132  
WESTMACOTT, nasal forceps ..... 117  
WIEDER, tongue depressor .....141  
WIENER, nasal rasp.....134  
WIENER, retractor.....86  
WILDE (TROELTSCH), ear forceps ...57  
WILLIGER, elevator.....101  
WILMER/CONVERSE/WALTER,  
scissors.....22  
Wire brush, nasal rasp.....138  
Wire twisting forceps, BERRY .....97  
Wire twisting forceps,  
MAYO-HABERISSER.....97

**Y**

YANCOSKIE, retractor .....83

**A**

Abre-boca DAVIS-BOYLE .....142  
 Abre-boca DAVIS-MEYER .....144  
 Abre-boca DINGMANN .....143  
 Abre-boca JENNINGS .....141  
 Abre-boca KILNER-DOUGHTY .....143  
 Abre-boca McIVOR .....144  
 ACKERMANN marcador para aréola...5  
 ADSON gancho para duramadre .....85  
 ADSON micro pinza de diseccion..... 38-39  
 ADSON pinza de diseccion ..... 38-39  
 ADSON pinza hemostatica .....64  
 ADSON tubo de aspiracion .....107  
 ADSON-BROWN pinza de diseccion.....40  
 ADSON-DeBAKEY pinza de diseccion.....38  
 AGRIS-DINGMAN separador mamario.....81  
 ALM separador .....75  
 ANDERSON separador .....84  
 ANDREW baja-lengua.....141  
 ASCH pinza para enderezar el tabique nasal .....140  
 AUFRICHT escofina nasal .....135  
 AUFRICHT separador nasal.....87

**B**

BABY OLSEN-HEGAR porta aguja....93  
 Baja-lengua ANDREW.....141  
 Baja-lengua McIVOR.....144  
 Baja-lengua RUSSEL-DAVIS .....145  
 Baja-lengua WIEDER.....141  
 BALLENGER cuchillo para el tabique nasal .....126  
 BALLENGER elevador para tabique.....104  
 BARON tubo de aspiracion .....107  
 BARRAQUER micro porta aguja .....95  
 BARRAQUER pinza depilatoria.....55  
 BARSKY separador.....71  
 BAUMGARTNER porta aguja.....92  
 BEASELEY BABCOCK pinza de diseccion .....39  
 BERKE pinza muscular .....55  
 BERRY pinza para torcer hilos.....97  
 BEUSE Face Lift tijera.....31  
 BEYER pinza gubia .....98  
 BIGGS separador .....79  
 BISHOP-HARMAN pinza para iris.....53

BLAIR instrumento para labios y fisura palatina .....106  
 BÖHLER pinza gubia ..... 98-99  
 BOIES elevador .....102  
 BONN Mod. pinza para sutura .....54  
 BONN tijera fina.....20  
 BONNEY pinza de diseccion .....45  
 BREAST separador .....81  
 BROWN pinza de diseccion .....41  
 BRUENINGS pinza para el tabique nasal .....119

**C**

Camisa para cirugía plástica .....80, 153-155  
 Cánulas de liposucción..... 159 -163  
 CAPLAN tijera nasale.....122  
 CASTROVIEJO compas.....5  
 CASTROVIEJO micro porta aguja .....96  
 CASTROVIEJO pinza para sutura .....55  
 Cepillo de alambre .....138  
 CHADWICK tijera fina .....26  
 Cíncel CINELLI .....127  
 Cíncel COTTLE .....129  
 Cíncel nasal FOMON.....127  
 Cíncel nasal FREER .....128  
 Cíncel nasal SHEEHAN.....127  
 Cíncel SILVER .....130  
 COLLER-CRILE pinza hemostatica ...61  
 COLLIER pelvimetro .....5  
 COLLIN-DUVAL pinza de diseccion.....42  
 Compas CASTROVIEJO .....5  
 CONVERSE cuchillo nasal .....125  
 CONVERSE separador .....89  
 CONVERSE separador nasal.....89  
 CONVERSE/WILMER/WALTER tijera fina .....22  
 CORONAL separador.....84  
 COTTLE cíncel .....129  
 COTTLE cuchillo nasal .....125  
 COTTLE elevador para tabique.....104  
 COTTLE escofina nasal .....135  
 COTTLE espejito nasal .....115-116  
 COTTLE JOSEPH elevador .....103  
 COTTLE legra .....104  
 COTTLE macha cadera.....133  
 COTTLE martillo.....100  
 COTTLE osteotomo.....129  
 COTTLE pinza para columela .....57  
 COTTLE pinza para fijacion .....57

COTTLE separador .....89  
 COTTLE separador nasal..... 87-88  
 COTTLE tijera fina.....22  
 COTTLE tijera nasal .....27  
 COTTLE-KAZANJIAN pinza gubia.....99  
 COTTLE-MASING tijera nasal .....27  
 COTTLE-NEIVERT separador nasal .....88  
 CRAIG pinza para el tabique nasal .....119  
 CRILE gancho para nervios .....85  
 CRILE pinza hemostatica .....62  
 CRILE separador.....65  
 CRILE-RANKIN pinza hemostatica .....62  
 CRILE-WOOD porta aguja .....92  
 CRONIN instrumento para labios y fisura palatina .....106  
 Cuchillo nasal CONVERSE .....125  
 Cuchillo nasal COTTLE .....125  
 Cuchillo nasal FREER .....124  
 Cuchillo nasal JOSEPH..... 124-125  
 Cuchillo nasal REDA .....125  
 Cuchillo para el tabique nasal BALLENGER .....126  
 CUSHING gancho para nervios .....85  
 CUSHING pinza de diseccion .....41  
 CUSHING-TAYLOR pinza de diseccion .....44

**D**

D'ASSUMPACO instrumento para marcar .....3  
 DAVIS-BOYLE abre-boca.....142  
 DAVIS-MEYER abre-boca.....144  
 DEAVER separador..... 67-68  
 DeBAKEY pinza atraumatica.....51  
 DeBAKEY porta aguja .....92  
 DERF porta aguja.....91  
 Dermatomo HUMBLY.....7  
 Dermatomo SCHINK .....6  
 Dermatomo SILVER .....7  
 Dermatomo WATSON .....7  
 DESMARRES pinza para chalazion...55  
 DESMARRES separador.....73  
 DINGMAN elevador .....150  
 DINGMAN escofina nasal .....138  
 DINGMAN legra.....150  
 DINGMANN abre-boca.....143  
 Disector GORNEY.....102  
 Disector LANGENBECK.....77  
 Disector LANGENBECK-COTTLE .....77

|                                  |    |
|----------------------------------|----|
| Disector MINI-LANGENBECK .....   | 77 |
| DURANTE pinza de diseccion ..... | 45 |
| DUVAL pinza de diseccion .....   | 42 |

**E**

|   |         |
|---|---------|
| Elevador BOIES .....                            | 102     |
| Elevador COTTLE JOSEPH .....                    | 103     |
| Elevador DINGMAN .....                          | 150     |
| Elevador FREER .....                            | 102     |
| Elevador HOWARTH .....                          | 103     |
| Elevador JOSEPH .....                           | 102-103 |
| Elevador KILLIAN .....                          | 103-104 |
| Elevador MASING .....                           | 102     |
| Elevador MCKENTY .....                          | 102-103 |
| Elevador para tabique<br>BALLENGER .....        | 104     |
| Elevador para tabique COTTLE .....              | 104     |
| Elevador para tabique<br>HAJEK-BALLENGER .....  | 104     |
| Elevador PENNINGTON .....                       | 103     |
| Elevador PIERCE .....                           | 103     |
| Elevador SINUS .....                            | 103     |
| Escofina nasal AUFRICHT .....                   | 135     |
| Escofina nasal COTTLE .....                     | 135     |
| Escofina nasal DINGMAN .....                    | 138     |
| Escofina nasal FOMON .....                      | 136-137 |
| Escofina nasal GLABELLA .....                   | 134     |
| Escofina nasal JOSEPH .....                     | 134-135 |
| Escofina nasal LEWIS .....                      | 135     |
| Escofina nasal MALTZ .....                      | 134-135 |
| Escofina nasal PARKES .....                     | 134     |
| Escofina nasal PEET .....                       | 134     |
| Escofina nasal WIENER .....                     | 134     |
| Espatula .....                                  | 80      |
| Espatula abdominal e intestinal<br>RIBBON ..... | 66      |
| Especulo nasal COTTLE .....                     | 115-116 |
| Especulo nasal HARTMANN .....                   | 111     |
| Especulo nasal<br>HARTMANN-HALLE .....          | 110     |
| Especulo nasal KILLIAN .....                    | 113-114 |
| Especulo nasal Mod. WIEN .....                  | 112     |
| Especulo nasal REDA .....                       | 112     |
| Especulo nasal TIECK-HALLE .....                | 112     |

**F**

|                                       |    |
|---------------------------------------|----|
| Face Lift tijera BEUSE .....          | 31 |
| Face Lift tijera GORNEY .....         | 30 |
| Face Lift tijera GORNEY-FREEMAN ..... | 30 |
| Face Lift tijera KAYE .....           | 31 |
| Face Lift tijera PECK-JOSEPH .....    | 31 |

|  |         |
|--|---------|
| FARABEU separador .....                      | 65      |
| FERGUSON/FRAZIER tubo de<br>aspiracion ..... | 108     |
| FERRIERA separador .....                     | 78      |
| FERRIS-SMITH pinza de<br>diseccion .....     | 42      |
| FINSEN separador .....                       | 75      |
| FOMON cinceles nasal .....                   | 127     |
| FOMON escofina nasal .....                   | 136-137 |
| FOMON legra .....                            | 101     |
| FOMON separador nasal .....                  | 88      |
| FOMON tijera nasal .....                     | 27      |
| FRAZIER separador .....                      | 70      |
| FRAZIER/FERGUSON tubo de<br>aspiracion ..... | 108     |
| FREEMAN marcador para aréola .....           | 4       |
| FREEMAN separador .....                      | 68, 84  |
| FREER Cincel nasal .....                     | 128     |
| FREER cuchillo nasal .....                   | 124     |
| FREER elevador .....                         | 102     |
| FREER gubia .....                            | 132     |
| FREER separador nasal .....                  | 88      |
| FRIEDMANN MICRO pinza gubia .....            | 98      |
| FRIEDMANN MINI pinza gubia .....             | 98      |
| FRIEDMANN pinza gubia .....                  | 98      |

**G**

|   |        |
|---|--------|
| Gancho MILLARD .....                      | 84     |
| Gancho para duramadre ADSON .....         | 85     |
| Gancho para nervios .....                 | 77, 85 |
| Gancho para nervios CRILE .....           | 85     |
| Gancho para nervios CUSHING .....         | 85     |
| Gancho para traqueotomia<br>JACKSON ..... | 90     |
| Gancho para traqueotomia NEWS .....       | 90     |
| GERALD pinza de diseccion .....           | 43-44  |
| GERZOG martillo .....                     | 100    |
| GILLIES pinza de diseccion .....          | 43     |
| GILLIES porta aguja .....                 | 94     |
| GILLIES separador .....                   | 89     |
| GLABELLA escofina nasal .....             | 134    |
| GOLDMAN-FOX tijera para encias .....      | 29     |
| Goniometro MOELTGEN .....                 | 2      |
| Goniometro para dedos .....               | 2      |
| GORNEY disector .....                     | 102    |
| GORNEY Face Lift tijera .....             | 30     |
| GORNEY separador .....                    | 84     |
| GORNEY tijera para nasale .....           | 122    |
| GORNEY-FREEMAN<br>Face Lift tijera .....  | 30     |
| GRADLE tijera fina .....                  | 23     |

|   |     |
|---|-----|
| GRAEFE pinza de diseccion .....                   | 41  |
| GRAEFE pinza para iris .....                      | 52  |
| GRAEFE separador .....                            | 69  |
| GRAEFE tijera fina .....                          | 22  |
| GREEN pinza para fijacion .....                   | 56  |
| GREENBERG-PAR tijera para<br>blefaroplastia ..... | 32  |
| GROSSMAN marcador para aréola .....               | 4   |
| Gubia FREER .....                                 | 132 |
| Gubia HAJEK .....                                 | 132 |
| Gubia KILLIAN .....                               | 130 |
| Gubia KILLIAN-CLAUS .....                         | 132 |
| Gubia WEST .....                                  | 132 |
| GUILLEN tubo de aspiracion .....                  | 109 |
| GUTHRIE separador .....                           | 69  |

**H**

|  |     |
|--|-----|
| HAJEK gubia .....                                  | 132 |
| HAJEK-BALLENGER elevador<br>para tabique .....     | 104 |
| HALPREN marcador para aréola .....                 | 5   |
| HALSEY porta aguja .....                           | 91  |
| HALSTEAD-MOSQUITO micro<br>pinza hemostatica ..... | 60  |
| HALSTEAD-MOSQUITO pinza<br>hemostatica .....       | 60  |
| HARTMANN especulo nasal .....                      | 111 |
| HARTMANN pinza hemostatica .....                   | 59  |
| HARTMANN pinza para polipos .....                  | 117 |
| HARTMANN-HALLE especulo<br>nasal .....             | 110 |
| HEYMAN tijera nasal .....                          | 27  |
| HEYMANN-KNIGHT pinza<br>para polipos .....         | 118 |
| Hoja de repuesto para dermatomo ...                | 6-7 |
| HOLZHEIMER separador .....                         | 75  |
| HOWARTH elevador .....                             | 103 |
| HUMBY dermatomo .....                              | 7   |
| HUMBY separador .....                              | 71  |

**I**

|  |         |
|--|---------|
| Instrumento para labios y fisura<br>palatina BLAIR .....   | 106     |
| Instrumento para labios y<br>fisura palatina CRIONIN ..... | 106     |
| Instrumento para marcar<br>D'ASSUMPACO .....               | 3       |
| Instrumento para marcar<br>LOCKWOOD .....                  | 3       |
| Instrumentos para endoscopia .....                         | 152-158 |



Instrumentos para labios y  
fisura palatina ..... 105-106  
IRIS tijera fina .....20

**J**

JACKSON gancho para  
traqueotomía .....90  
JAEGER placa para parado .....58  
JANSEN separador .....75  
JANSEN-GRUENWALD pinza  
auricular .....57  
JENNINGS abre-boca ..... 141  
JOSEPH cuchillo nasal ..... 124-125  
JOSEPH elevador ..... 102-103  
JOSEPH escofina nasal ..... 134-135  
JOSEPH legra .....101  
JOSEPH separador .....70  
JOSEPH sierra nasal ..... 138-139  
JOSEPH tijera de disección .....18  
JOST macha cadera .....133

**K**

KASDAN separador .....73  
KAYE Face Lift tijera .....31  
KAYE tijera para blefaroplastia .....32  
KELLY pinza hemostática .....61  
KELLY tijera de disección .....19  
KELLY-RANKIN pinza hemostática .....  
.....61  
KILLIAN elevador ..... 103-104  
KILLIAN espejuelo nasal ..... 113-114  
KILLIAN gubia .....130  
KILLIAN-CLAUS gubia .....132  
KILLNER separador nasal .....88  
KILNER RAGNELL tijera de  
disección .....19  
KILNER-DOUGHTY abre-boca .....143  
KLAPP separador .....72  
KLEINERT-LUTZ separador .....70  
KNAPP separador .....86  
KNAPP tijera fina .....21  
KNIGHT pinza para el tabique  
nasal .....118

**L**

LA GRANGE tijera fina .....26  
LAHEY separador .....70  
LAMBOTTE-MINI osteotomo .....132  
LANGE separador .....89  
LANGENBECK disector .....77  
LANGENBECK legra .....101

LANGENBECK-COTTLE disector .....77  
Legra COTTLE .....104  
Legra DINGMAN .....150  
Legra FOMON .....101  
Legra JOSEPH .....101  
Legra LANGENBECK .....101  
Legra OBWEGESER .....149  
Legra WILLIGER .....101  
LERCHE pinza de disección .....41  
LERICHE pinza hemostática .....63  
LEWIS escofina nasal .....135  
LEXER tijera de disección .....15  
LEXER-BABY tijera de disección .....15  
LITTAUER tijera para hilos .....28  
LITTLER tijera fina .....22  
LOCKWOOD instrumento para  
marcar .....3  
LOCKWOOD, Separador mamaros...82  
LUBET-BARBON pinza para  
taponamiento .....117  
LUC pinza para el tabique nasal .....119  
LUCAE pinza auricular .....57

**M**

MacCOLLUM-DINGMAN separador  
mamario .....81  
Macha cadera COTTLE .....133  
Macha cadera JOST .....133  
MALINIAC separador nasal .....87  
MALTZ escofina nasal ..... 134-135  
Mango de bisturí ..... 8-12  
Marcador para areola  
ACKERMANN .....5  
Marcador para areola FREEMAN .....4  
Marcador para areola GROSSMAN .....4  
Marcador para areola HALPREN .....5  
Marcador para areola McKISSOCK .....5  
Marcador para facelift PITANGUY .....3  
Martillo COTTLE .....100  
Martillo GERZOG .....100  
Martillo MEAD .....100  
Martillo PARTSCH .....100  
Martillo QUISLING .....100  
Martillos .....100  
MARTINEZ-KILNER separador .....89  
MASING elevador .....102  
MASING-NEIVERT separador  
nasal .....87  
MAYO tijera de disección .....13  
MAYO-HABERISSER pinza para  
torcer hilos .....97

MAYO-HEGAR porta aguja .....92  
MAYO-STILLE tijera de disección .....14  
MC INDOE pinza gubia .....99  
MC INDOE tijera para cartilago .....29  
McINDOE pinza de disección .....42  
McIVOR abre-boca .....144  
McIVOR baja-lengua .....144  
McKENTY elevador ..... 102-103  
McKISSOCK marcador para  
aréola .....5  
MEAD martillo .....100  
METZENBAUM tijera de disección .....  
16-17  
METZENBAUM-FINO tijera de  
disección .....17  
MEYERDING separador .....74  
MICRO FRIEDMANN pinza gubia .....98  
Micro pinzas ..... 47-49  
Micro porta aguja BARRAQUER .....95  
Micro porta aguja CASTROVIEJO .....96  
Micro tijeras ..... 33-35  
MICROVASCULAR porta aguja .....93  
MIDDLETON-JANSEN pinza para el  
tabique nasal .....123  
MILLARD gancho .....84  
MILLER separador .....86  
MINI-LAMBOTTE osteotomo .....132  
MINI-LANGENBECK disector .....77  
Mod. BONN pinza para sutura .....54  
Mod. RUSO pinza de disección .....42  
Mod. TUEBINGEN pinza para sutura .....  
54  
Mod. WIEN espejuelo nasal .....112  
MOELTGEN goniometro .....2  
MYLES pinza cortante nasal .....121

**N**

NEIVERT-ANDERSON osteotomo .....130  
NEWS gancho para traqueotomía .....90

**O**

O'BRIEN tijera para hilos .....28  
O'CONNOR separador .....86  
OBWEGESER legra .....149  
OBWEGESER osteotomo .....131  
OBWEGESER separador para  
cirugiade boca-mandibula-fiscal .....  
146-148  
OCHSNER pinza de disección .....45  
OEHLER pinza de disección .....37  
OLSEN-HEGAR BABY porta aguja .....93

|                                  |     |   |       |   |       |
|----------------------------------|-----|---|-------|---|-------|
| OLSEN-HEGAR porta aguja .....    | 93  | Pinza de diseccion GILLIES .....        | 43    | Pinza para el tabique nasal KNIGHT..... | 118   |
| Osteotomo CINELLI .....          | 127 | Pinza de diseccion GRAEFE .....         | 41    | Pinza para el tabique nasal LUC .....   | 119   |
| Osteotomo COTTLE .....           | 129 | Pinza de diseccion LERCHE .....         | 41    | Pinza para el tabique nasal             |       |
| Osteotomo MINI-LAMBOTTE .....    | 132 | Pinza de diseccion McINDOE .....        | 42    | MIDDLETON-JANSEN .....                  | 123   |
| Osteotomo NEIVERT-ANDERSON ..... | 130 | Pinza de diseccion Mod. RUSO .....      | 42    | Pinza para el tabique nasal RUBIN ..... | 122   |
| Osteotomo OBWEGESER .....        | 131 | Pinza de diseccion OCHSNER .....        | 45    | Pinza para enderezar el tabique         |       |
| Osteotomo RUBIN .....            | 129 | Pinza de diseccion OEHLER .....         | 37    | nasal ASCH .....                        | 140   |
| Osteotomo SHEEHAN .....          | 127 | Pinza de diseccion POTTS-SMITH .....    | 36    | Pinza para enderezar el tabique         |       |
| Osteotomo TESSIER .....          | 151 | Pinza de diseccion SEMKEN .....         | 43    | nasal WALSHAM .....                     | 140   |
| Osteotomo WEST .....             | 132 | Pinza de diseccion SINGLEY .....        | 45    | Pinza para fijacion COTTLE .....        | 57    |
|                                  |     | Pinza de diseccion STILLE .....         | 36-37 | Pinza para fijacion GREEN .....         | 56    |
|                                  |     | Pinza de diseccion                      |       | Pinza para iris BISHOP-HARMAN .....     | 53    |
|                                  |     | STILLE-BARRAYA .....                    | 45    | Pinza para iris GRAEFE .....            | 52    |
|                                  |     | Pinza de diseccion TAYLOR .....         | 44    | Pinza para polipos HARTMANN .....       | 117   |
|                                  |     | Pinza de diseccion                      |       | Pinza para polipos                      |       |
|                                  |     | TAYLOR-CUSHING .....                    | 44    | HEYMANN-KNIGHT .....                    | 118   |
|                                  |     | Pinza de diseccion USA .....            | 36-37 | Pinza para sutura CASTROVIEJO .....     | 55    |
|                                  |     | Pinza de diseccion WAUGH .....          | 41    | Pinza para sutura Mod. BONN .....       | 54    |
|                                  |     | Pinza depilatoria BARRAQUER .....       | 55    | Pinza para sutura                       |       |
|                                  |     | Pinza gubia BEYER .....                 | 98    | Mod. TUEBINGEN .....                    | 54    |
|                                  |     | Pinza gubia BÖHLER .....                | 98-99 | Pinza para taponamiento                 |       |
|                                  |     | Pinza gubia COTTLE-KAZANJIAN .....      | 99    | LUBET-BARBON .....                      | 117   |
|                                  |     | Pinza gubia FRIEDMANN .....             | 98    | Pinza para taponamiento                 |       |
|                                  |     | Pinza gubia FRIEDMANN MINI .....        | 98    | WESTMACOTT .....                        | 117   |
|                                  |     | Pinza gubia MC INDOE .....              | 99    | Pinza para torcer hilos BERRY .....     | 97    |
|                                  |     | Pinza gubia MICRO FRIEDMANN .....       | 98    | Pinza para torcer hilos                 |       |
|                                  |     | Pinza hemostatica ADSON .....           | 64    | MAYO-HABERISSER .....                   | 97    |
|                                  |     | Pinza hemostatica COLLER-CRILE .....    | 61    | Pinzas atraumaticas con TC .....        | 50    |
|                                  |     | Pinza hemostatica CRILE .....           | 62    | Pinzas de diseccion sin y con           |       |
|                                  |     | Pinza hemostatica CRILE-RANKIN .....    | 62    | dientes .....                           | 36-45 |
|                                  |     | Pinza hemostatica                       |       | Pinzas para espinas .....               | 46    |
|                                  |     | HALSTEAD-MOSQUITO .....                 | 60    | PITANGUY marcador para facelift .....   | 3     |
|                                  |     | Pinza hemostatica                       |       | Placa para extender la piel .....       | 6     |
|                                  |     | HALSTEAD-MOSQUITO micro .....           | 60    | Placa para parado JAEGER .....          | 58    |
|                                  |     | Pinza hemostatica HARTMANN .....        | 59    | Porta aguja BABY OLSEN-HEGAR .....      | 93    |
|                                  |     | Pinza hemostatica KELLY .....           | 61    | Porta aguja BAUMGARTNER .....           | 92    |
|                                  |     | Pinza hemostatica KELLY-RANKIN .....    | 61    | Porta aguja CRILE-WOOD .....            | 92    |
|                                  |     | Pinza hemostatica LERICHE .....         | 63    | Porta aguja DeBAKEY .....               | 92    |
|                                  |     | Pinza hemostatica                       |       | Porta aguja DERF .....                  | 91    |
|                                  |     | ROCHESTER-OCHSNER .....                 | 63    | Porta aguja GILLIES .....               | 94    |
|                                  |     | Pinza hemostatica                       |       | Porta aguja HALSEY .....                | 91    |
|                                  |     | ROCHESTER-PEAN .....                    | 63    | Porta aguja MAYO-HEGAR .....            | 92    |
|                                  |     | Pinza muscular BERKE .....              | 55    | Porta aguja MICROVASCULAR .....         | 93    |
|                                  |     | Pinza para chalazion DESMARRES .....    | 55    | Porta aguja OLSEN-HEGAR .....           | 93    |
|                                  |     | Pinza para columela COTTLE .....        | 57    | Porta aguja RYDER .....                 | 93    |
|                                  |     | Pinza para el tabique nasal             |       | Porta aguja WEBSTER .....               | 91    |
|                                  |     | BRUENINGS .....                         | 119   | POTTS-SMITH pinza de diseccion .....    | 36    |
|                                  |     | Pinza para el tabique nasal CRAIG ..... | 119   | PROVIDENCE-HOSPITAL pinza               |       |
|                                  |     | .....                                   | 119   | hemostatica .....                       | 61    |

**Q**

QUISLING martillo.....100

**R**

RAGNELL separador.....65  
 RAMUS separador para cirugía de boca-mandibula-fiscal.....148  
 REDA cuchillo nasal.....125  
 REDA especulo nasal.....112  
 REDA separador.....72  
 Regla.....2  
 REYNOLDS JAMESON tijera de diseccion.....19  
 REYNOLDS (Transauxillary) Separadores mamarios.....81-82  
 RIBBON espátula abdominal e intestinal.....66  
 ROCHESTER-OCHSNER pinza hemostatica.....63  
 ROCHESTER-PEAN pinza hemostatica.....63  
 ROLLET separador.....86  
 ROUX mini separador.....65  
 RUBIN osteotomo.....129  
 RUBIN pinza para el tabique nasal.....122  
 RUSO Mod. pinza de diseccion.....42  
 RUSSEL-DAVIS baja-lengua.....145  
 RYDER porta aguja.....93

**S**

SANVENERO tijera de diseccion.....18  
 SCHINK dermatomo.....6  
 SCHMEDEN pinza cortante nasal.....121  
 SCULPO separador con camisa para cirugía plástica.....79  
 SEMKEN pinza de diseccion.....43  
 Separador ALM.....75  
 Separador ANDERSON.....84  
 Separador BARSKY.....71  
 Separador BIGGS.....79  
 Separador BREAST.....81  
 Separador con camisa para cirugía plástica SCULPO.....79  
 Separador CONVERSE.....89  
 Separador CORONAL.....84  
 Separador COTTLE.....89  
 Separador CRILE.....65  
 Separador de mobilizacion TESSIER.....150  
 Separador DEAVER.....67-68  
 Separador DESMARRES.....73

Separador FARABEUF.....65  
 Separador FERRIERA.....78  
 Separador FINSEN.....75  
 Separador FRAZIER.....70  
 Separador FREEMAN.....68, 84  
 Separador GILLIES.....89  
 Separador GORNEY.....84  
 Separador GRAEFE.....69  
 Separador GUTHRIE.....69  
 Separador HOLZHEIMER.....75  
 Separador HUMBY.....71  
 Separador JANSEN.....75  
 Separador JOSEPH.....70  
 Separador KASDAN.....73  
 Separador KLAPP.....72  
 Separador KLEINERT-LUTZ.....70  
 Separador KNAPP.....86  
 Separador LAHEY.....70  
 Separador LANGE.....89  
 Separador mamario AGRIS-DINGMAN.....81  
 Separador mamario MacCOLLUM-DINGMAN.....81  
 Separador mamarios LOCKWOOD.....82  
 Separador mamario REYNOLDS (Transauxillary).....81  
 Separador mamario SILVERSTEIN.....82  
 Separador mamario TEBBETTS.....81  
 Separador MARTINEZ-KILNER.....89  
 Separador MEYERDING.....74  
 Separador MILLER.....86  
 Separador nasal AUFRIEHT.....87  
 Separador nasal CONVERSE.....87  
 Separador nasal COTTLE.....87-89  
 Separador nasal COTTLE-NEIVERT.....88  
 Separador nasal FOMON.....88  
 Separador nasal FREER.....88  
 Separador nasal KILLNER.....88  
 Separador nasal MALINIAC.....87  
 Separador nasal MASING-NEIVERT.....87  
 Separador O'CONNOR.....86  
 Separador para cirugía de boca-mandibula-fiscal OBWEGESER.....146-148  
 Separador para cirugía de boca-mandibula-fiscal RAMUS.....148  
 Separador para cirugía de boca-mandibula-fiscal SPINA-NASALIS.....148

Separador RAGNELL.....65  
 Separador REDA.....72  
 Separador ROLLET.....86  
 Separador ROUX mini.....65  
 Separador STRANDELL-STILLE.....74  
 Separador TEBBETTS.....78  
 Separador TYRELL.....69  
 Separador VOLKMAN.....73  
 Separador WEITLANER.....76  
 Separador WIENER.....86  
 Separador YANCOSKIE.....83  
 Separadores para cirugía plástica.....78-81  
 Sierra nasal JOSEPH.....138-139  
 SHEEHAN cincel.....127  
 SILVER cincel.....130  
 SILVER dermatomo.....7  
 SILVERSTEIN separador mamario.....82  
 SINGLEY pinza de diseccion.....45  
 SINUS elevador.....103  
 SPENCER tijera para hilos.....28  
 SPINA-NASALIS separador para cirugía de boca-mandibula-fiscal.....148  
 STEVENS tijera fina.....24  
 STILLE pinza de diseccion.....36-37  
 STILLE-BARRAYA pinza de diseccion.....45  
 STRABISMUS tijera fina.....24  
 STRANDELL-STILLE separador.....74

**T**

TAKAHASHI pinza cortante nasal.....121  
 TAYLOR pinza de diseccion.....44  
 TAYLOR-CUSHING pinza de diseccion.....44  
 TEBBETTS separador.....78  
 TEBBETTS separador mamario.....81  
 TESSIER osteotomo.....151  
 TESSIER separador de mobilizacion.....150  
 TIECK-HALLE especulo nasal.....112  
 Tijera de diseccion JOSEPH.....18  
 Tijera de diseccion KELLY.....19  
 Tijera de diseccion KILNER RAGNELL.....19  
 Tijera de diseccion LEXER.....15  
 Tijera de diseccion LEXER-BABY.....15  
 Tijera de diseccion MAYO.....13  
 Tijera de diseccion MAYO-STILLE.....14  
 Tijera de diseccion METZENBAUM.....16-17

|   |     |
|---|-----|
| Tijera de diseccion                         |     |
| METZENBAUM-FINO.....                        | 17  |
| Tijera de diseccion REYNOLDS                |     |
| JAMESON .....                               | 19  |
| Tijera de diseccion SANVENERO .....         | 18  |
| Tijera fina BONN .....                      | 20  |
| Tijera fina CHADWICK .....                  | 26  |
| Tijera fina CONVERSE/WILMER/<br>WALTER..... | 22  |
| Tijera fina COTTLE.....                     | 22  |
| Tijera fina GRADLE .....                    | 23  |
| Tijera fina GRAEFE .....                    | 22  |
| Tijera fina IRIS .....                      | 20  |
| Tijera fina KNAPP.....                      | 21  |
| Tijera fina LA GRANGE .....                 | 26  |
| Tijera fina LITTLER .....                   | 22  |
| Tijera fina para oftalmologia .....         | 23  |
| Tijera fina STEVENS .....                   | 24  |
| Tijera fina STRABISMUS .....                | 24  |
| Tijera fina WAGNER.....                     | 25  |
| Tijera fina WILMER/CONVERSE .....           | 22  |
| Tijera nasal COTTLE.....                    | 27  |
| Tijera nasal COTTLE-MASING .....            | 27  |
| Tijera nasal FOMON.....                     | 27  |
| Tijera nasal HEYMAN.....                    | 27  |
| Tijera para blefaroplastia                  |     |
| GREENBERG-PAR .....                         | 32  |
| Tijera para blefaroplastia KAYE.....        | 32  |
| Tijera para cartilago MC INDOE.....         | 29  |
| Tijera para encias GOLDMAN-FOX .....        | 29  |
| Tijera para hilos LITTAUER.....             | 28  |
| Tijera para hilos O' BRIEN .....            | 28  |
| Tijera para hilos SPENCER.....              | 28  |
| Tijera para nasales CAPLAN.....             | 122 |
| Tijera para nasales GORNEY.....             | 122 |
| TROELTSCH pinza auricular.....              | 57  |
| Tubo de aspiracion ADSON .....              | 107 |
| Tubo de aspiracion BARON .....              | 107 |
| Tubo de aspiracion                          |     |
| FRAZIER/FERGUSSON .....                     | 108 |
| Tubo de aspiracion GUILLEN .....            | 109 |
| TUEBINGEN Mod. pinza para sutura.....       |     |
| .....                                       | 54  |
| TYRELL separador.....                       | 69  |

**U**

|                             |       |
|-----------------------------|-------|
| USA pinza de diseccion..... | 36-37 |
|-----------------------------|-------|

**V**

|                          |    |
|--------------------------|----|
| VOLKMANN separador ..... | 73 |
|--------------------------|----|

**W**

|  |     |
|--|-----|
| WAGNER tijera fina .....                               | 25  |
| WALSHAM pinza para enderezar el<br>tabique nasal ..... | 140 |
| WALTER/CONVERSE/WILMER<br>tijera fina .....            | 22  |
| WATSON dermatomo .....                                 | 7   |
| WAUGH pinza de diseccion .....                         | 41  |
| WEBSTER porta aguja.....                               | 91  |
| WEIL-BLAKESLEY pinza cortante<br>nasal.....            | 120 |
| WEITLANER separador .....                              | 76  |
| WEST gubia .....                                       | 132 |
| WEST osteotomo .....                                   | 132 |
| WESTMACOTT pinza para<br>taponamiento.....             | 117 |
| WIEDER baja-lengua .....                               | 141 |
| WIEN Mod. especulo nasal .....                         | 112 |
| WIENER escofina nasal .....                            | 134 |
| WIENER separador.....                                  | 86  |
| WILDE (TROELTSCH) pinza<br>auricular.....              | 57  |
| WILLIGER legra .....                                   | 101 |
| WILMER/CONVERSE/WALTER<br>tijera fina .....            | 22  |

**Y**

|                          |    |
|--------------------------|----|
| YANCOSKIE separador..... | 83 |
|--------------------------|----|

## A

|   |     |
|---|-----|
| Abbassalingua Andrew .....                          | 141 |
| Abbassalingua Davis-Boyle .....                     | 142 |
| Abbassalingua Dingmann .....                        | 143 |
| Abbassalingua Kilner-Doughty .....                  | 143 |
| Abbassalingua Russel-Davis .....                    | 145 |
| Abbassalingua Wieder .....                          | 141 |
| ACKERMANN strumento per marcare .....               | 5   |
| ADSON cannula di aspirazione .....                  | 107 |
| ADSON pinza emostatica .....                        | 64  |
| ADSON uncini per dura-madre .....                   | 85  |
| AGRIS-DINGMAN separatori<br>mammari .....           | 81  |
| ALM divaricatori .....                              | 75  |
| ANDERSON uncini per pelle .....                     | 84  |
| ANDREW abbassalingua .....                          | 141 |
| Apribocca completo Davis-Boyle .....                | 142 |
| Apribocca Dingmann .....                            | 143 |
| Apribocca Jennings .....                            | 141 |
| Apribocca Kilner-Doughty .....                      | 143 |
| ASCH pinza per raddrizzare il setto<br>nasale ..... | 140 |
| AUFRIEHT raspa nasale .....                         | 135 |
| AUFRIEHT retrattori nasali .....                    | 87  |

## B

|   |     |
|---|-----|
| Baby OLSEN HEGAR portaghi .....                 | 93  |
| BABY-WEBSTER portaghi .....                     | 91  |
| BALLENGER coltello per setto .....              | 126 |
| BALLENGER elevatore per setto .....             | 104 |
| BARON Cannula di aspirazione .....              | 107 |
| BARRAQUER micro portaghi .....                  | 95  |
| BARRAQUER pinza depilatoria .....               | 55  |
| BARSKY uncinetto per pelle .....                | 71  |
| BAUMGARTNER portaghi .....                      | 92  |
| BERKE pinze muscolari .....                     | 55  |
| BERRY Pinza torcifili .....                     | 97  |
| BEUSE face lift forbici .....                   | 31  |
| BEYER pinza sgorbia .....                       | 98  |
| BIGGS divaricatore con luce fredda .....        | 79  |
| BISHOP-HARMAN pinze per iride .....             | 53  |
| Bisturi per cartilagine Joseph .....            | 124 |
| Bisturi per rinoplastica Converse .....         | 125 |
| Bisturi per rinoplastica Cottle .....           | 125 |
| Bisturi per rinoplastica Joseph .....           | 124 |
| BLAIR elevatore per fessure del<br>palato ..... | 106 |
| BOEHLER cesoie per ossa .....                   | 99  |
| BOEHLER pinza sgorbia .....                     | 98  |
| BOIES sgorbia periostotomo .....                | 102 |

|  |     |
|--|-----|
| BONN forbice delicata .....                  | 20  |
| BONNEY pinza anatomica .....                 | 45  |
| BONNEY pinze chirurgiche .....               | 45  |
| BREAST divaricatore .....                    | 80  |
| BROWN Pinze chirurgiche .....                | 41  |
| BRUENINGS pinza per il setto<br>nasale ..... | 119 |

## C

|   |         |
|---|---------|
| Camicia per chirurgia plastica .....              | 80      |
| .....   | 153-155 |
| Cannula di aspirazione .....                      | 107     |
| Cannula di aspirazione Baron .....                | 107     |
| Cannula di aspirazione Guilen .....               | 109     |
| Cannule di aspirazione<br>Frazier/Fergusson ..... | 108     |
| Cannule per liposuzione .....                     | 159-163 |
| CAPLAN forbici nasali .....                       | 122     |
| CASTROVIEJO compasso .....                        | 5       |
| CASTROVIEJO micro portaghi .....                  | 96      |
| CASTROVIEJO pinze per sutura .....                | 55      |
| CHADWICK forbici gengivali .....                  | 26      |
| CINELLI scalpelli nasale .....                    | 127     |
| COLLER-CRILE pinze emostatiche .....              | 61      |
| COLLIER compasso .....                            | 5       |
| COLLIN DUVAL pinza fenestrata .....               | 42      |
| Coltello falcato REDA .....                       | 125     |
| Coltello per il setto nasale Freer .....          | 124     |
| Coltello per mucosa Freer .....                   | 124     |
| Coltello per setto BALLENGER .....                | 126     |
| Compasso Castroviejo .....                        | 5       |
| Compasso Collier .....                            | 5       |
| CONVERSE bisturi per rinoplastica .....           | 125     |
| CONVERSE divaricatore .....                       | 89      |
| CONVERSE retrattori nasali .....                  | 87      |
| CONVERSE/WILMER/WALTER<br>forbici delicate .....  | 22      |
| CORONAL divaricatore .....                        | 84      |
| COTTLE bisturi per setto nasale .....             | 125     |
| COTTLE divaricatori .....                         | 89      |
| COTTLE elevatore per setto .....                  | 103-104 |
| Cottle forbici delicate .....                     | 22      |
| COTTLE forbici nasali .....                       | 27      |
| COTTLE KAZANJIAN cesoia per<br>ossa .....         | 99      |
| COTTLE martello metallico .....                   | 100     |
| COTTLE osteotomo .....                            | 129     |
| COTTLE pinza per columella .....                  | 57      |
| COTTLE retrattore nasale .....                    | 87-88   |
| COTTLE scalpello per plastica nasale .....        | 129     |

|  |         |
|--|---------|
| Cottle specoli nasali .....                | 115-116 |
| COTTLE Tritacartilagine .....              | 133     |
| COTTLE-JOSEPH elevatore per<br>setto ..... | 103     |
| COTTLE-MASING forbici nasali .....         | 27      |
| COTTLE-NEIVERT retrattore<br>nasale .....  | 88      |
| CRAIG pinza per il setto nasale .....      | 119     |
| CRILE divaricatore doppio .....            | 65      |
| CRILE pinze emostatiche .....              | 62      |
| CRILE RANKIN pinze emostatiche .....       | 62      |
| CRILE uncini per nervi .....               | 85      |
| CRILE WOOD portaghi .....                  | 92      |
| CRONIN coltello .....                      | 105     |
| CUSHING pinza anatomica .....              | 41      |
| CUSHING pinza chirurgica 1x2 .....         | 41      |
| CUSHING uncini per nervi .....             | 85      |
| CUSHING-TAYLOR pinza a<br>baionetta .....  | 44      |

## D

|  |       |
|--|-------|
| D'ASSUMPCAO strumento per<br>marcare ..... | 3     |
| DAVIS BOYLE abbassalingua .....            | 142   |
| DAVIS BOYLE apribocca completo .....       | 142   |
| DAVIS BOYLE Telaio solo .....              | 142   |
| DAVIS MEYER Telaio solo .....              | 144   |
| DE BAKEY portaghi .....                    | 92    |
| DEAVER divaricatori addominali .....       | 67-68 |
| DEBAKEY micro pinza atraumatica .....      | 49    |
| DEBAKEY pinze atraumatiche .....           | 51    |
| DEBAKEY pinze atraumatiche TC .....        | 50    |
| DERAF portaghi .....                       | 91    |
| Dermatomo Humby .....                      | 7     |
| Dermatomo Schink .....                     | 6     |
| Dermatomo Silver .....                     | 7     |
| Dermatomo Watson .....                     | 7     |
| DESMARRES divaricatori .....               | 73    |
| DESMARRES pinze per calazio .....          | 55    |
| DINGMAN divaricatore .....                 | 150   |
| DINGMAN periostotomo doppio .....          | 150   |
| DINGMAN raspa nasale .....                 | 138   |
| DINGMANN abbassalingua .....               | 143   |
| DINGMANN apribocca .....                   | 143   |
| Dischi di ricambio per martello .....      | 100   |
| Dissetore Gorney .....                     | 102   |
| Dissettori Williger .....                  | 101   |
| Divaricat.dopp.coppia Farabeuf .....       | 65    |
| Divaricatore .....                         | 150   |
| Divaricatore Breast .....                  | 80    |
| Divaricatore con luce fredda Biggs .....   | 79    |

|   |         |
|---|---------|
| Divaricatore Converse.....                                  | 89      |
| Divaricatore Coronal.....                                   | 84      |
| Divaricatore Dingman.....                                   | 150     |
| Divaricatore doppio Crile.....                              | 65      |
| Divaricatore doppio Ragnel.....                             | 65      |
| Divaricatore doppio Roux.....                               | 65      |
| Divaricatore Gorney.....                                    | 84      |
| Divaricatore Kasdan.....                                    | 73      |
| Divaricatore Knapp.....                                     | 86      |
| Divaricatore Lange.....                                     | 89      |
| Divaricatore Martinez-Kilner.....                           | 89      |
| Divaricatore Miller.....                                    | 86      |
| Divaricatore Obwegeser.....                                 | 146-148 |
| Divaricatore O'Connor.....                                  | 86      |
| Divaricatore per chirurgia plastica.....                    | 78-81   |
| Divaricatore Ramus.....                                     | 148     |
| Divaricatore Rollet.....                                    | 86      |
| Divaricatore Spina-Nasalis.....                             | 148     |
| Divaricatore Tessier.....                                   | 150     |
| Divaricatori.....   | 72      |
| Divaricatori addominali DEAVER... 67-68                     |         |
| Divaricatori Alm.....                                       | 75      |
| Divaricatori con camicia per chirurgia plastica Sculpo..... | 79      |
| Divaricatori Cottle.....                                    | 89      |
| Divaricatori Desmarres.....                                 | 73      |
| Divaricatori Ferriera.....                                  | 78      |
| Divaricatori Finsen.....                                    | 75      |
| Divaricatori Freeman.....                                   | 68, 84  |
| Divaricatori Gillies.....                                   | 89      |
| Divaricatori Holzheimer.....                                | 75      |
| Divaricatori Jansen.....                                    | 75      |
| Divaricatori Klapp.....                                     | 72      |
| Divaricatori Lahey.....                                     | 70      |
| Divaricatori Meyerding.....                                 | 74      |
| Divaricatori Strandel-Stille.....                           | 74      |
| Divaricatori Tebbets.....                                   | 78      |
| Divaricatori Volkman.....                                   | 73      |
| Divaricatori Weitlaner.....                                 | 76      |
| Divaricatori Wiener.....                                    | 86      |
| Divaricatori Yancoskie.....                                 | 83      |
| DURANTE pinze anatomiche.....                               | 45      |
| DUVAL pinza fenestrata.....                                 | 4       |

**E**

|                                     |         |
|-------------------------------------|---------|
| Elettrodi monopolari.....           | 158     |
| Elevatore Langenbeck.....           | 101     |
| Elevatore per periostio Masing..... | 102     |
| Elevatore per setto.....            | 104     |
| Elevatore per setto Cottle.....     | 103-104 |

|  |         |
|--|---------|
| Elevatore per setto Cottle-Joseph.....   | 103     |
| Elevatore per setto Freer.....           | 102     |
| Elevatore per setto Hajek-Ballenger..... | 104     |
| Elevatore per setto Howarth.....         | 103     |
| Elevatore per setto Joseph.....          | 102     |
| Elevatore per setto Killian.....         | 103-104 |
| Elevatore per setto McKenty.....         | 102-103 |
| Elevatore per setto Pennington.....      | 103     |
| Elevatore per setto Pierce.....          | 103     |
| Elevatore per setto Sinus.....           | 103     |
| Endo dissettore Langenbeck.....          | 77      |
| Endo dissettore Langenbeck-Cottle.....   | 77      |
| Endo dissettore Mini-Langenbeck.....     | 77      |

**F**

|  |         |
|--|---------|
| Face lift forbici Gorney.....                | 30      |
| Face lift forbici Gorney-Freemann.....       | 30      |
| Face lift forbici Kaye.....                  | 31      |
| Face lift forbici Peck-JOSEPH.....           | 31      |
| FARABEUF divaricat.dopp.coppia.....          | 65      |
| FERRIERA divaricatori.....                   | 78      |
| FERRIS SMITH pinze chirurgiche.....          | 42      |
| FINSEN divaricatori.....                     | 75      |
| FOMON forbici nasali.....                    | 27      |
| FOMON Periostotomo.....                      | 101     |
| FOMON raspa nasale doppia.....               | 136-137 |
| FOMON retrattori nasali.....                 | 88      |
| FOMON scalpelli nasale.....                  | 127     |
| Forbice delicata Bonn.....                   | 20      |
| Forbici blefaroplastica.....                 | 32      |
| Forbici blefaroplastica Greenberg-Par.....   | 32      |
| Forbici delicate.....                        | 20-25   |
| Forbici delicate CONVERSE/WILMER/WALTER..... | 22      |
| Forbici delicate Cottle.....                 | 22      |
| Forbici delicate Gradle.....                 | 23      |
| Forbici delicate Graefe.....                 | 22      |
| Forbici delicate IRIS.....                   | 20      |
| Forbici delicate Knapp.....                  | 21      |
| Forbici delicate Littler.....                | 22      |
| Forbici delicate Wagner.....                 | 25      |
| Forbici endoscopici.....                     | 156     |
| Forbici gengivali Chadwick.....              | 26      |
| Forbici gengivali Goldmann-Fox.....          | 29      |
| Forbici gengivali La Grange.....             | 26      |
| Forbici gengivali Mc Indoe.....              | 29      |
| Forbici nasali Caplan.....                   | 122     |
| Forbici nasali Cottle.....                   | 27      |
| Forbici nasali Cottle-Masing.....            | 27      |

|  |        |
|--|--------|
| Forbici nasali Fomon.....                    | 27     |
| Forbici nasali Gorney.....                   | 122    |
| Forbici nasali Heymann.....                  | 27     |
| Forbici per dissezione.....                  | 13-19  |
| Forbici per dissezione Joseph.....           | 18     |
| Forbici per dissezione Kilner.....           | 19     |
| Forbici per dissezione Lexer-Baby.....       | 15     |
| Forbici per dissezione Mayo.....             | 13     |
| Forbici per dissezione Mayo-Stille.....      | 14     |
| Forbici per dissezione Metzenbaum.....       | 16-17  |
| Forbici per dissezione Sanvenero.....        | 18     |
| Forbici per strabismo.....                   | 24     |
| Forbici taglia fili Littauer.....            | 28     |
| Forbici taglia fili O'Brien.....             | 28     |
| Forbici taglia fili Spencer.....             | 28     |
| FRAZIER uncinetto.....                       | 70     |
| FRAZIER/FERGUSON cannula di aspirazione..... | 108    |
| FREEMAN divaricatori.....                    | 68, 84 |
| FREEMAN strumento per marcare.....           | 4      |
| FREER coltello per il setto nasale.....      | 124    |
| FREER coltello per mucosa.....               | 124    |
| FREER elevatore per setto.....               | 102    |
| FREER retrattore nasale.....                 | 88     |
| FREER scalpelli per plastica nasale.....     | 128    |
| FREER sgorbia nasale.....                    | 132    |
| FRIEDMAN micro pinza sgorbia.....            | 98     |
| FRIEDMAN mini pinza sgorbia.....             | 98     |

**G**

|                                       |     |
|---------------------------------------|-----|
| Ganci per tracheotomia Jackson.....   | 90  |
| Gancio per tracheotomia News.....     | 90  |
| GERALD pinza chirurgica 1x2.....      | 43  |
| GERALD pinze anatomiche.....          | 43  |
| GERALD pinze chirurgiche.....         | 44  |
| GERZOG Martello metallico.....        | 100 |
| GILLIES Divaricatori.....             | 89  |
| GILLIES pinze 1x2 denti.....          | 43  |
| GILLIES portaghi tagliente.....       | 94  |
| GLABELLA raspa nasale.....            | 134 |
| GOLDMANN-FOX forbici gengivali.....   | 29  |
| Goniometro Moeltgen.....              | 2   |
| Goniometro per le dita.....           | 2   |
| GORNEY dissettore.....                | 102 |
| GORNEY divaricatore.....              | 84  |
| GORNEY face lift forbici.....         | 30  |
| GORNEY forbici nasali.....            | 122 |
| GORNEY-FREEMAN face lift forbici..... | 30  |
| GRADLE forbici delicate.....          | 23  |

GRAEFE forbici delicate.....22  
 GRAEFE pinza morsi dentellati .....41  
 GRAEFE pinze per iride .....52  
 GRAEFE uncinetto acuto .....69  
 GRAEFE uncinetto smusso.....69  
 GREEN pinze fissatrici .....56  
 GREENBERG-PAR forbici  
 bleforoplastica .....32  
 GROSSMAN, strumento per marcare .....  
 .....4  
 GUILÉN cannula di aspirazione .....109  
 GUTHRIE uncinetto doppio acuto .....69  
 GUTHRIE uncinetto doppio smusso.....69

**H**

HAJEK sgorbia .....132  
 HAJEK-BALLENGER elevatore per  
 setto.....104  
 HALPREN strumento per marcare .....5  
 HALSEY portaghi .....91  
 HALSTED-Mosquito micro pinze.....60  
 HALSTED-Mosquito pinze.....60  
 HARTMANN pinza per polipi nasali.....  
 .....117  
 HARTMANN pinze emostatiche .....59  
 HARTMANN specoli nasali.....111  
 HARTMANN-HALLE specoli nasali...110  
 HEYMANN forbici nasali.....27  
 HEYMANN KNIGHT pinza nasale.....118  
 HOLZHEIMER divaricatori.....75  
 HOWARTH elevatore per setto .....103  
 HUMBY dermatomo .....7  
 HUMBY uncinetto doppio per pelle .....71

**I**

IRIS forbici delicate .....20

**J**

JACKSON ganci per tracheotomia.....90  
 JANSEN divaricatori.....75  
 JANSEN-GRUENWALD pinza  
 auricolare .....57  
 JENNINGS apribocca .....141  
 JOSEPH (LEWIS) raspa nasale .....135  
 JOSEPH bisturi per cartilagine .....124  
 JOSEPH bisturi per rinoplastica .....124  
 JOSEPH elevatore per setto .....102  
 JOSEPH forbici per dissezione .....18  
 JOSEPH lima per ossa .....134  
 JOSEPH Periostotomo .....101  
 JOSEPH sega nasale .....138

JOSEPH sega nasale angolata .....139  
 JOSEPH uncino mucosa .....70  
 JOST tritacartilagine .....133

**K**

KASDAN divaricatore .....73  
 KAYE face lift forbici .....31  
 KAYE forbici bleforoplastica .....32  
 KELLY forbici per dissezione .....19  
 KELLY pinze emostatiche.....51  
 KELLY RANKIN pinze emostatiche .....61  
 KILLAN specoli nasali.....113-114  
 KILLIAN CLAUD sgorbia .....132  
 KILLIAN elevatore per setto .....103-104  
 KILLIAN sgorbia .....130  
 KILNER DOUGHTY abbassalingua .....  
 .....143  
 KILNER DOUGHTY apribocca .....143  
 KILNER forbici per dissezione.....19  
 KILNER retrattore nasale .....88  
 Klapp divaricatori.....72  
 KLEINERT-KUTZ uncinetto acuto  
 per pelle .....70  
 KNAPP divaricatore.....86  
 KNAPP forbici delicate .....21  
 KNIGHT pinza per il setto.....118

**L**

La GRANGE forbici gengivali .....26  
 LAHEY divaricatori .....70  
 Lama di ricambio per dermatomo.....6  
 Lama di ricambio, non sterile.....7  
 Lame per bisturi.....11  
 LANGE divaricatore .....89  
 LANGENBECK elevatore .....101  
 LANGENBECK Endo disettore.....77  
 LANGENBECK-COTTLE  
 Endo disettori.....77  
 LERCHE pinza 5x6 denti.....41  
 LERICHE pinze emostatiche .....63  
 LEXER forbici per dissezione .....15  
 LEXER-BABY forbici per dissezione .....  
 .....15  
 Lima per ossa Joseph .....134  
 LITTAUER forbici taglia fili.....28  
 LITTLER forbici delicate .....22  
 LOCKWOOD, Separatori mammari.....82  
 LOCKWOOD strumento per marcare .....  
 .....3  
 LUBET-BARBON pinza per medicature ..  
 .....117

LUC pinza tagliante per il setto nasale....  
 .....119  
 LUCAE pinze auricolari .....57

**M**

MacCollum-DINGMANN separatori  
 mammari .....81  
 MAINIAC retrattore nasale .....87  
 MALTZ (COTTLE) raspa nasale .....135  
 MALTZ raspa nasale .....134  
 Manici per lame bisturi.....8-12  
 Martelli .....100  
 Martello intranasale Quisling .....100  
 Martello Mead.....100  
 Martello metallico Cottle .....100  
 Martello metallico Gerzog.....100  
 Martello metallico Partsch .....100  
 MARTINEZ-KILNER divaricatore .....89  
 MASING elevatore per periostio.....102  
 MASING-NEIVERT retrattore nasale .....  
 .....87  
 MAYO forbici per dissezione .....13  
 Mayo-HaberISSER pinze torcibili .....97  
 MAYO-Hegar portaghi .....92  
 MAYO-Stille forbici per dissezione .....14  
 MC INDOE cesoia per ossa .....99  
 MC Indoe forbici gengivali .....29  
 McINDOE pinza 1x2 denti .....42  
 McINDOE pinza anatomica .....42  
 McIVOR abbassalingua .....144  
 McIVOR apribocca completo .....144  
 McKENTY elevatore per setto .....  
 .....102-103  
 McKISSOCK, strumento per marcare .....  
 .....5  
 MEAD martello .....100  
 METZENBAUM forbici per dissezione....  
 .....16-17  
 MEYERDING divaricatori .....74  
 Micro forbici .....33-35  
 Micro pinze ad anello.....48  
 Micro pinze Halsted-Mosquito .....60  
 Micro pinze per legature.....47  
 Micro portaghi Barraquer.....95  
 Micro portaghi Castroviejo.....96  
 MICROVASCULAR portaghi .....93  
 MIDDLETON JANSEN pinza per il  
 setto nasale .....123  
 MILLARD uncini.....84  
 MILLER divaricatore .....86  
 MINI-LAMBOTTE osteotomo.....132

|                                       |     |
|---------------------------------------|-----|
| MINI-LANGENBECK Endo dissettore ..... | 77  |
| MOELTGEN goniometro .....             | 2   |
| MYLES pinza nasale tagliente.....     | 121 |

**N**

|                                    |     |
|------------------------------------|-----|
| NEIVERT-ANDERSON Osteotomo ...     | 130 |
| NEWS gancio per tracheotomia ..... | 90  |

**O**

|                                   |         |
|-----------------------------------|---------|
| O'BRIEN forbici taglia fili ..... | 28      |
| OBWEGESER divaricatore .....      | 146-148 |
| OBWEGESER Osteotomo .....         | 131     |
| OBWEGESER periostotomo .....      | 149     |
| OCHSNER pinza per dissezione..... | 45      |
| O'CONNOR divaricatore .....       | 86      |
| OLSEN HEGAR portaghi.....         | 93      |
| Osteotomo Cinelli .....           | 127     |
| Osteotomo Cottle.....             | 129     |
| Osteotomo fomon .....             | 127     |
| Osteotomo Mini-Lambotte .....     | 132     |
| Osteotomo nasale Silver .....     | 130     |
| Osteotomo nasale West .....       | 132     |
| Osteotomo Neivert-Anderson .....  | 130     |
| Osteotomo Obwegeser.....          | 131     |
| Osteotomo Rubin.....              | 129     |
| Osteotomo sheehan .....           | 127     |
| Osteotomo Tessier.....            | 151     |
| Ottica per endoplastica.....      | 152     |

**P**

|   |     |
|---|-----|
| PARKES raspa nasale.....                | 134 |
| PARTSCH martello metallico.....         | 100 |
| PECK-JOSEPH face lift forbici .....     | 31  |
| PEET raspa nasale.....                  | 134 |
| PENNINGTON Elevatore per setto ...      | 103 |
| Periostotomo doppio Dingman .....       | 150 |
| Periostotomo Fomon .....                | 101 |
| Periostotomo Joseph.....                | 101 |
| Periostotomo Obwegeser .....            | 149 |
| PIERCE Elevatore per setto .....        | 103 |
| Pinza 1 x 2 denti Potts-Smith .....     | 36  |
| Pinza 1x2 denti McIndoe .....           | 42  |
| Pinza 5x6 denti Lerche .....            | 41  |
| Pinza a baionetta Taylor .....          | 44  |
| Pinza anatomica McIndoe .....           | 42  |
| Pinza anatomica Bonney.....             | 45  |
| Pinza anatomica Cushing.....            | 41  |
| Pinza anatomica Potts-Smith .....       | 36  |
| Pinza auricolare Jansen-Gruenwald.....  | 57  |
| Pinza auricolare Wilde (Troeltsch)..... | 57  |

|  |     |
|--|-----|
| Pinza chirurgica 1x2 Gerald .....                  | 43  |
| Pinza chirurgica Cushing.....                      | 41  |
| Pinza chirurgica Stille .....                      | 37  |
| Pinza con cucchiaino, modello russo .....          | 42  |
| Pinza depilatoria Barraquer.....                   | 55  |
| Pinza emostatica ADSON.....                        | 64  |
| Pinza fenestrata Collin-Duval .....                | 42  |
| Pinza fenestrata Duval .....                       | 42  |
| Pinza morsi dentellati Graefe .....                | 41  |
| Pinza nasale Heymann-Knight .....                  | 118 |
| Pinza nasale tagliente Myles .....                 | 121 |
| Pinza nasale tagliente Schmeden .....              | 121 |
| Pinza nasale tagliente Takahashi .....             | 121 |
| Pinza p. diss. 1x2 denti .....                     | 37  |
| Pinza p. dissezione. micro.....                    | 43  |
| Pinza per appiattamento setto nasale Rubin.....    | 122 |
| Pinza per columella Cottle.....                    | 57  |
| Pinza per dissezione Ochsner.....                  | 45  |
| Pinza per il setto Knight.....                     | 118 |
| Pinza per il setto nasale Brünings .....           | 119 |
| Pinza per il setto nasale Craig.....               | 119 |
| Pinza per il setto nasale Middleton Jansen .....   | 123 |
| Pinza per medicature Lubet-Baron.....              | 117 |
| Pinza per medicature Westmacott.....               | 117 |
| Pinza per polipi nasali HARTMANN .....             | 117 |
| Pinza per raddrizzare il setto nasale Asch.....    | 140 |
| Pinza per raddrizzare il setto nasale Walsham..... | 140 |
| Pinza sgorbia Beyer .....                          | 98  |
| Pinza sgorbia BOEHLER .....                        | 98  |
| Pinza sgorbia Friedmann.....                       | 98  |
| Pinza sgorbia mini Friedman .....                  | 98  |
| Pinza tagliente nasale Weil-Blakesley .....        | 120 |
| Pinza tagliente per il setto nasale Luc.....       | 119 |
| Pinza torcifili Berry.....                         | 97  |
| Pinza USA 1x2 denti .....                          | 37  |
| Pinza USA p. dissezione .....                      | 36  |
| Pinze 1x2 denti Gillies .....                      | 43  |
| Pinze 1x2 denti Semken .....                       | 43  |
| Pinze ADSON, chirurgiche .....                     | 39  |
| Pinze ADSON, chirurgiche/ anatomiche .....         | 38  |
| Pinze ADSON-BROWN, chirurgiche .....               | 40  |
| Pinze anatomiche Durante .....                     | 45  |
| Pinze anatomiche Gerald .....                      | 43  |

|  |       |
|--|-------|
| Pinze anatomiche Semken.....                       | 43    |
| Pinze anatomiche Stille .....                      | 36    |
| Pinze atraumatiche DeBakey .....                   | 50-51 |
| Pinze auricolari Lucae.....                        | 57    |
| Pinze auricolari Troeltsch .....                   | 57    |
| Pinze chirurgiche 2x3 denti .....                  | 37    |
| Pinze chirurgiche 3x4 denti .....                  | 37    |
| Pinze chirurgiche 4x5 denti .....                  | 37    |
| Pinze chirurgiche Brown.....                       | 41    |
| Pinze chirurgiche Ferris-Smith .....               | 42    |
| Pinze chirurgiche Gerald .....                     | 44    |
| Pinze chirurgiche Stille-Barraya .....             | 45    |
| Pinze chirurgiche Waugh.....                       | 41    |
| Pinze da presa per endoscopia.....                 | 157   |
| Pinze emostatiche Coller-Crile .....               | 61    |
| Pinze emostatiche Crile.....                       | 62    |
| Pinze emostatiche Crile-Rankin .....               | 62    |
| Pinze emostatiche Hartmann .....                   | 59    |
| Pinze emostatiche Kelly .....                      | 61    |
| Pinze emostatiche Kelly-Rankin .....               | 61    |
| Pinze emostatiche Leriche .....                    | 63    |
| Pinze emostatiche Providence-Hospital .....        | 61    |
| Pinze emostatiche Rochester-Ochsner .....          | 63    |
| Pinze emostatiche Rochester-Pean.....              | 63    |
| Pinze fissatrici Green.....                        | 56    |
| Pinze Halsted-Mosquito.....                        | 60    |
| Pinze muscolari BERKE .....                        | 55    |
| Pinze per calazio Desmarres.....                   | 55    |
| Pinze per dissezione chirurgiche.....              | 37    |
| Pinze per dissezione, chirurgiche/anatomiche ..... | 36    |
| Pinze per iride Bishop-Harman.....                 | 53    |
| Pinze per iride Graefe.....                        | 52    |
| Pinze per schegge.....                             | 46    |
| Pinze per sutura Castroviejo .....                 | 55    |
| Pinze per sutura mod. Bonn .....                   | 54    |
| Pinze per sutura mod. Tuebingen.....               | 54    |
| Pinze per tessuti Singley .....                    | 45    |
| Pinze torcifili Mayo-Haberisser.....               | 97    |
| PITANGUY strumento per marcare .....               | 3     |
| Placca per palpebre .....                          | 58    |
| Placca per stendipelle .....                       | 6     |
| Portaghi Baby Olsen-Hegar.....                     | 93    |
| Portaghi Baby-Webster .....                        | 91    |
| Portaghi Baumgartner .....                         | 92    |
| Portaghi Crile-Wood .....                          | 92    |
| Portaghi DeBakey.....                              | 92    |
| Portaghi Derf .....                                | 91    |
| Portaghi Halsey .....                              | 91    |



|   |    |
|---|----|
| Portaghi Mayo-Hegar .....                   | 92 |
| Portaghi microvascular .....                | 93 |
| Portaghi Olsen-Hegar .....                  | 93 |
| Portaghi Ryder .....                        | 93 |
| Portaghi tagliente Gillies .....            | 94 |
| Portaghi Webster .....                      | 91 |
| POTTS SMITH pinze anatomiche .....          | 36 |
| POTTS-SMITH pinza 1 x 2 denti .....         | 36 |
| Providence-Hospital pinze emostatiche ..... | 61 |

## Q

|                                     |     |
|-------------------------------------|-----|
| QUISLING martello intranasale ..... | 100 |
|-------------------------------------|-----|

## R

|  |         |
|--|---------|
| RAGNEL divaricatore doppio .....                 | 65      |
| RAMUS divaricatore .....                         | 148     |
| Raspa nasal Dingman .....                        | 138     |
| Raspa nasale Aufricht .....                      | 135     |
| Raspa nasale doppia Fomon .....                  | 136-137 |
| Raspa nasale Glabella .....                      | 134     |
| Raspa nasale Joseph Lewis .....                  | 135     |
| Raspa nasale Maltz .....                         | 134     |
| Raspa nasale Maltz (Cottle) .....                | 135     |
| Raspa nasale Parkes .....                        | 134     |
| Raspa nasale Peet .....                          | 134     |
| Raspa nasale Wiener .....                        | 134     |
| REDA coltello falcato .....                      | 125     |
| Regolo metal.grad.mm/pollici .....               | 2       |
| Retratore nasale Freer .....                     | 88      |
| Retratore nasale Kilner .....                    | 88      |
| Retratore nasale Maliniac .....                  | 87      |
| Retratore nasale Masing-Neivert .....            | 87      |
| Retrattori nasali Aufricht .....                 | 87      |
| Retrattori nasali Converse .....                 | 87      |
| Retrattori nasali Cottle .....                   | 87-88   |
| Retrattori nasali Fomon .....                    | 88      |
| Retratore nasale Cottle-Neivert .....            | 88      |
| REYNOLDS forbici per dissezione .....            | 19      |
| REYNOLDS (Transauxillary) .....                  |         |
| Separatori mammari .....                         | 81-82   |
| RIBBON spatole addominali .....                  | 66      |
| ROCHESTER OCHSNER pinze emostatiche .....        | 63      |
| ROCHESTER PEAN pinze emostatiche .....           | 63      |
| ROLLET divaricatore .....                        | 86      |
| ROUX mini divaricat.doppio .....                 | 65      |
| RUBIN osteotomo .....                            | 129     |
| RUBIN pinza per appiattamento setto nasale ..... | 122     |

|                                  |     |
|----------------------------------|-----|
| RUSSEL-DAVIS abbassalingua ..... | 145 |
| RYDER portaghi .....             | 93  |

## S

|  |         |
|--|---------|
| SANVENERO forbici per dissezione .....                       | 18      |
| Scalpello per plastica nasale Cottle .....                   | 129     |
| Scalpellini per plastica nasale Freer .....                  | 128     |
| SCHINK Dermatomo .....                                       | 6       |
| SCHMEDEN pinza nasale tagliente .....                        | 121     |
| SCULPO divaricatori con camicia per chirurgia plastica ..... | 79      |
| Sega nasale angolata Joseph .....                            | 139     |
| Sega nasale Joseph .....                                     | 138     |
| SEMKEN pinze 1x2 denti .....                                 | 43      |
| SEMKEN pinze anatomiche .....                                | 43      |
| Separatori mammari Agris-Dingman .....                       | 81      |
| Separatori mammari MacCollum-Dingmann .....                  | 81      |
| Separatori mammari LOCKWOOD .....                            | 82      |
| Separatori mammari REYNOLDS (Transauxillary) .....           | 81      |
| Separatori mammari Silverstein .....                         | 82      |
| Separatori mammari Tebbetts .....                            | 81      |
| Sgorbia Freer .....  | 132     |
| Sgorbia Hajek .....  | 132     |
| Sgorbia Killian .....  | 130     |
| Sgorbia Killian-Claus .....                                  | 132     |
| Sgorbia nasale West .....                                    | 132     |
| Sgorbia periostotomo Boies .....                             | 102     |
| SHEEHAN scalpelli nasale .....                               | 127     |
| SILVER dermatomo .....                                       | 7       |
| SILVER osteotomo nasale .....                                | 130     |
| SILVERSTEIN separatori mammari .....                         | 82      |
| SINGLEY pinze per tessuti .....                              | 45      |
| SINUS elevatore per setto .....                              | 103     |
| Spatola .....  | 80      |
| Spatole addominali Ribbon .....                              | 66      |
| Spazzolino .....   | 138     |
| Specoli nasali .....   | 112     |
| Specoli nasali Cottle .....                                  | 115-116 |
| Specoli nasali Hartmann .....                                | 111     |
| Specoli nasali Hartmann-Halle .....                          | 110     |
| Specoli nasali Killian .....                                 | 113-114 |
| Specoli nasali Tieck-Halle .....                             | 112     |
| Specoli nasali, mod. Wien .....                              | 112     |
| SPENCER forbici taglia fili .....                            | 28      |
| SPINA-NASALIS divaricatore .....                             | 148     |
| STEVENS forbici delicate .....                               | 24      |
| STILLE pinza chirurgica .....                                | 37      |
| STILLE pinze anatomiche .....                                | 36      |

|   |     |
|---|-----|
| STILLE-BARRAYA pinze chirurgiche .....    | 45  |
| STRANDELL-STILLE divaricatori .....       | 74  |
| Strumenti per labbra e palato .....       | 105 |
| Strumenti per labbra e palato Blair ..... | 106 |
| Strumento per marcare D'Assumpcao .....   | 3   |
| Strumento per marcare Lockwood .....      | 3   |
| Strumento per marcare Pitanguy .....      | 3   |
| Strumento per marcare, Ackermann .....    | 5   |
| Strumento per marcare, FREEMAN .....      | 4   |
| Strumento per marcare, GROSSMAN .....     | 4   |
| Strumento per marcare, Halpren .....      | 5   |
| Strumento per marcare, McKissock .....    | 5   |

## T

|  |     |
|--|-----|
| TAKAHASHI pinza nasale tagliente ..... | 121 |
| TAYLOR pinza a baionetta .....         | 44  |
| TAYLOR pinza anatomica .....           | 44  |
| TAYLOR pinza chirurgica 1x2 .....      | 44  |
| TEBBETTS divaricatori .....            | 78  |
| TEBBETTS Separatori mammari .....      | 81  |
| Telaio solo per Davis Boyle .....      | 142 |
| Telaio solo per Davis-Meyer .....      | 144 |
| Telaio solo per Dingmann .....         | 143 |
| Telaio solo per Kilner-Doughty .....   | 143 |
| TESSIER divaricatore .....             | 150 |
| TESSIER Osteotomo .....                | 151 |
| TIECK HALLE specoli nasali .....       | 112 |
| Tritacartilagine Cottle .....          | 133 |
| Tritacartilagine Jost .....            | 133 |
| TROELTSCH pinze auricolari .....       | 57  |
| TYRELL uncinetto acuto .....           | 69  |

## U

|   |    |
|---|----|
| Uncinetto acuto Frazier .....                 | 70 |
| Uncinetto acuto Graefe .....                  | 69 |
| Uncinetto acuto per pelle Kleinert-Kutz ..... | 70 |
| Uncinetto acuto Tyrell .....                  | 69 |
| Uncinetto doppio acuto Guthrie .....          | 69 |
| Uncinetto doppio per pelle Humby .....        | 71 |
| Uncinetto doppio smusso Guthrie .....         | 69 |
| Uncinetto per pelle Barsky .....              | 71 |
| Uncinetto smusso Frazier .....                | 70 |
| Uncinetto smusso Graefe .....                 | 69 |
| Uncini Millard .....                          | 84 |
| Uncini per dura-madre Adson .....             | 85 |
| Uncini per nervi Crile .....                  | 85 |
| Uncini per nervi Cushing .....                | 85 |
| Uncini per nervi destra e sinistra .....      | 77 |

|                                |    |
|--------------------------------|----|
| Uncini per pelle Anderson..... | 84 |
| Uncino mucosa Joseph.....      | 70 |

**V**

|                            |    |
|----------------------------|----|
| VOLKMANN divaricatori..... | 73 |
|----------------------------|----|

**W**

|   |     |
|---|-----|
| WAGNER forbici delicate.....                          | 25  |
| WALSHAM pinza per raddrizzare il<br>setto nasale..... | 140 |
| WALTER/CONVERSE/WILMER<br>forbici delicate.....       | 22  |
| WATSON dermatomo.....                                 | 7   |
| WAUGH pinze chirurgiche.....                          | 41  |
| WEBSTER portaghi.....                                 | 91  |
| WEIL BLAKESLEY pinza tagliente<br>nasale.....         | 120 |
| WEITLANER divaricatori.....                           | 76  |
| WEST osteotomo nasale.....                            | 132 |
| WEST sgorbia nasale.....                              | 132 |
| WESTMACOTT pinza per medicature ....<br>.....         | 117 |
| WIEDER abbassalingua.....                             | 141 |
| WIENER divaricatori.....                              | 86  |
| WIENER raspa nasale.....                              | 134 |
| WILDE (TROELTSCH) pinza<br>auricolare.....            | 57  |
| WILLIGER dissettori.....                              | 101 |

**Y**

|                             |    |
|-----------------------------|----|
| YANCOSKIE divaricatori..... | 83 |
|-----------------------------|----|



Weitere Kataloge und Prospekte  
Other cataloges and prospects

Hauptkatalog Chirurgische Instrumente  
General catalog surgical instruments

HNO  
ENT

Arthroskopie  
Arthroscopy

Container Steriltechnik  
Container Sterilization Technique

Endoskopie  
Endoscopy

HERCULES® Drahtkneifzange  
HERCULES® Wire Cutters

Neurochirurgie  
Neuro Surgery

Orthopädie  
Orthopedic

Titan Instrumente  
Titanium Instruments



**INSTRUMENTE GMBH**

Gänsäcker 34  
P.O. Box 131  
D-78532 Tuttlingen  
Germany



Fon +49 7462.9445-0  
Fax +49 7462.9445-20  
[info@Reda-Instrumente.de](mailto:info@Reda-Instrumente.de)  
[www.Reda-Instrumente.de](http://www.Reda-Instrumente.de)

