



Neurochirurgie
Neurosurgery
Neurocirugia
Neurochirurgia



Reda Instrumente GmbH

Gänsäcker 34 - P.O. Box 131
D-78532 Tuttlingen

Telefon +49/7462/9445-0

Telefax +49/7462/9445-20

e-mail: info@Reda-Instrumente.de

<http://www.Reda-Instrumente.de>

Ausgabe Nr. 2

Datum: 08/2011

Charrière (Ch) French (F)	Durchmesser in mm	Inches
1	0,33	0,013
2	0,67	0,025
3	1,00	0,039
4	1,33	0,051
5	1,67	0,065
6	2,00	0,0787
7	2,33	0,092
8	2,67	0,105
9	3,00	0,1181
10	3,33	0,131
11	3,67	0,144
12	4,00	0,1575
13	4,33	0,170
14	4,67	0,184
15	5,00	0,1968
16	5,33	0,210
17	5,67	0,223
18	6,00	0,2362
19	6,33	0,249
20	6,67	0,263
21	7,00	0,2756
22	7,33	0,288
23	7,67	0,302
24	8,00	0,3150
25	8,33	0,328
26	8,67	0,341
27	9,00	0,3543
28	9,33	0,367
29	9,67	0,380
30	10,00	0,3973
31	10,33	0,407
32	10,67	0,420
34	11,33	0,446
36	12,00	0,4724
38	12,67	0,494
40	13,33	0,5199
45	15,00	0,5905

Gauge (G)	Durchmesser in mm	Inches
35	0,13	0,005
34	0,18	0,007
33	0,20	0,008
32	0,23	0,009
31	0,25	0,010
30	0,30	0,012
29	0,33	0,013
28	0,36	0,014
27	0,41	0,016
26	0,46	0,018
25	0,51	0,020
	0,53	0,021
24	0,56	0,022
23	0,64	0,025
22	0,71	0,028
21	0,81	0,032
20	0,89	0,035
	0,97	0,038
19	1,07	0,042
18	1,27	0,050
17	1,50	0,059
16	1,65	0,065
15	1,83	0,072
14	2,11	0,083
13	2,41	0,095
12	2,77	0,109
11	3,05	0,120
10	3,40	0,134
9	3,76	0,148
8	4,19	0,165
7	4,57	0,180
6	5,16	0,203

1 OZ	0,028 ml
5 OZ	0,140 ml
16 OZ	0,450 ml

35 OZ	1,0 l
128 OZ	3,7 l



GARANTIE / WARRANTY / GARANTIA / GARANZIA

GARANTIE

Wir gewähren auf alle **Reda**-Instrumente 5 Jahre Garantie. Voraussetzung ist der sach- und fachgerechte Einsatz der Instrumente. Von der Garantie sind Verschleißerscheinungen ausgeschlossen.

WARRANTY

Our **Reda** products are free from manufacturing defects in material and workmanship. We therefore give on all instruments a guarantee of five years provided that the instruments are maintained and cleaned properly and used normally for their intended purpose.

GARANTIA

Estamos convencidos de nuestra calidad y concedemos a todos los instrumentos de **Reda** 5 años de garantía contra cualquier defecto de fabricación, siempre y cuando se usen adecuadamente. De la garantía excluimos la manifestación de desgaste.

GARANZIA

Siamo convinti della nostra qualità e concediamo cinque anni di garanzia sulla funzione dei tutti gli strumenti **Reda** sotto la presupposizione che l'utilizzo è da esperto. Escluso della garanzia sono tracce di consumo.

Arbeitsanweisung Aufbereitung (Reinigung) und Sterilisation von resterilisierbaren chirurgischen Instrumenten

DIN EN ISO 17664:2004 (D)

Hersteller:
REDA Instrumente GmbH, Gänsäcker 34
78532 Tuttlingen

Alle von Reda gelieferten wieder verwendbaren Instrumente wurden ausschließlich für den chirurgischen Gebrauch konstruiert und dürfen zu keinen anderen Zwecken benutzt werden. Unsachgemäße Handhabung und sorglose Pflege sowie zweckentfremdeter Gebrauch können zu vorzeitigem Verschleiß der Instrumente führen. Die Produkte sind bei der Auslieferung nicht sterilisiert.

Reinigungsvorbereitung

Fabrikneue Instrumente müssen vor der ersten Anwendung den gesamten Aufbereitungsprozess durchlaufen. Instrumente unmittelbar nach Anlieferung aus den Folienverpackungen entnehmen und in trockenen Räumen bei gleichbleibender Raumtemperatur luftoffen lagern, um Kondensationsbildung zu vermeiden.

Die Instrumente keinen Sonnenlichteinstrahlungen oder Dämpfen durch Chemikalien (Säuren oder scharfe Reinigern) aussetzen.

Vor der ersten Sterilisation alle Schutzkappen und Folien vollständig entfernen und anschließend reinigen.

Gebrauchte Instrumente unmittelbar nach Beendigung des Eingriffs von Blut, Gewebe und Arzneimittel reinigen. Instrumente in eine freigegebene Lösung eines kombinierten Reinigungs- und Desinfektionsmittels, das keine proteinfixierende Wirkung besitzt, einlegen.

Dosierung des Herstellers beachten. Nicht in NaCl Lösung einlegen, ansonsten Gefahr für Loch- bzw. Spannungsriss-Korrosion

Überfüllung von Instrumentensieben und Wasch-Trays vermeiden.

Gelenkinstrumente vor dem Aufbereiten öffnen. Zerlegbare Instrumente gemäß Bedienungsanleitung (Piktogramm) zur Reinigung zerlegen. Reinigungsgerechtes Zubehör verwenden. Für die manuelle Reinigung nie Metallbürsten oder Metallschwämme verwenden.

Spülmaschinen und Ultraschallanlagen nicht überladen. Spül- oder Schallschatten vermeiden. Dosierung, Einwirkzeit und Einwirktemperatur bei der Desinfektion und Reinigung unbedingt einhalten. Nach der Reinigung sorgfältig spülen. Möglichst vollentsalztes (demineralisiertes) Wasser verwenden.

Nach dem Spülen ausreichend trocknen. Abgenutzte, korrodierte, deformierte, poröse oder anderweitig beschädigte Instrumente austrieren.

Aus hygienischen Gründen müssen Instrumente, die zur Reparatur eingesandt werden komplett aufbereitet werden.

Gelenkinstrumente nach jeder Aufbereitung mit einem Pflegemittel auf Basis von Paraffinöl behandeln (gilt nicht für flexible Endoskope und Zubehör).

Funktionsprüfung in zusammengebautem Zustand durchführen.

Instrumente mit Rastensperre vor der Sterilisation nur im ersten Zahn schließen.

Als Sterilisationsverfahren empfehlen wir die Dampfsterilisation (üblicherweise mit Sattedampf bei 134° C)

Sterilisation ist kein Ersatz für Sauberkeit!

Die Broschüre "Instrumenten-Aufbereitung richtig gemacht" des Arbeitskreis Instrumenten-Aufbereitung dient als Anhalt.

Reda Instrumente GmbH
78532 Tuttlingen

IMPORTANT INFORMATION CONCERNING PREPARING AND STERILIZING SURGICAL INSTRUMENTS

Dear Sirs,
please read the following instructions very carefully before using the instruments.

1. INITIAL USE

All instruments which are being used for the first time must be thoroughly cleaned, rinsed and then sterilized before using.

2. TREATING INSTRUMENTS AFTER USAGE

- a.) The instruments might be immediately thoroughly cleaned and disinfected. Please follow the manufacturer's instructions when using cleaning agents and disinfectants.
- b.) Instruments which may be dismantled must be cleaned and disinfected after being taken apart.
- c.) Cleaning may be carried out either manually or with a machine. Care should be taken that only cleaning agents and disinfectants are used, which are changed daily.
- d.) Following chemical disinfection and manual cleaning, all instruments must always be thoroughly rinsed under running water.
- e.) The temperature of water used in a machine for cleaning should not exceed 45°C.
- f.) Whether cleaning is carried out manually or by machine, we especially ask you to ensure that the correct dosage for cleaning solutions or the correct combination of disinfectant and cleaning solution, is employed. Similar importance should be applied to the length of time the agents require to perform properly and to the temperature set.
- g.) Hinged instruments should be opened before cleaning.
- h.) Please ensure that the perforated instrument trays, when loaded, do not exceed 10 kg in weight.
- i.) Please take care that when instruments are being cleaned they are arranged proper in a manne that fluids can circulate freely.
- j.) Deposits remaining after the cleaning process must be completely removed in the first rinse which now follows. The optimum temperature for final rinsing has proved to be between 70° and 90° C. Please use only purified water in this final cleaning stage.
- k.) The instruments must be carefully dried after cleaning and rinsing is completed.
- l.) Moving parts and the cutting edges of shears and scissors must be treated with preservatives which are both suitable and physiologically safe.

3. TESTING FOR CORRECT FUNCTIONING

- a.) Instruments must be carefully and thoroughly checked before every occasion that they are used.

- b.) After each time they are cleaned, the instruments must be macroscopically clean, i.e., visibly free from proteinbased residues and other soiling.
- c.) Care should be taken so that cracks, breakages and corrosion are noticed.
- d.) Instruments with flecks should be separated and taken out for special treatment.
- e.) All moving parts as well as working tips and blades should be checked with special care.
- f.) Checking should be carried out according to the extent to which the instruments will be used.
- g.) Instruments which are in any way defective or damaged should be immediately sorted out from the others.

4. STERILIZATION

- a.) All stainless steel surgical instruments supplied by us may be sterilized in an autoclave.
- b.) Please follow the manufacturer's operating instructions when using autoclave. All machines used must comply with all current quality and other standards.
- c.) Instruments are being sterilized/ autoclaved at a temperature of 134°C.
- d.) Sterilization packing material must comply with all current standards.
- e.) Instruments with ratchets or self-retaining mechanisms should be sterilized opened or in the first ratchet position.
- f.) Please ensure that perforated instrument trays, when loaded do not exceed 10 kg in weight.

5. IN GENERAL

- a.) All surgical instruments supplied by us have been thoroughly inspected before dispatch and leave our factory in perfect condition. Damage which can arise as a result of transporting, cleaning, preserving, sterilizing or storing, must be prevented.
- b.) Please handle surgical instruments always with the utmost care.
- c.) Instruments must be stored in a clean and dry place.
- d.) If you have any queries or problems please contact us at any time:

We should like to point out that, if the above-mentioned directions are not followed or the instruments supplied by us are not properly used, all guarantee claims become void and any consequences must be borne by yourselves.

SUGERENCIAS PARA LA LIMPIEZA, ESTERILIZACIÓN Y MANTENIMIENTO DE INSTRUMENTOS QUIRÚRGICOS

ENJUAGADO

Tras el uso enjuagar enseguida los instrumentos bajo un chorro de agua caliente (no hirviendo). El enjuagado debe servir para quitar los residuos de sangre, mucosas y tejidos.

LIMPIEZA

Si la limpieza no se efectúa inmediatamente después del enjuagado, los instrumentos tienen que sumergirse en una solución de agua y detergente con PH neutro (7)

Para los instrumentos muy delicados (algunos tipos de porta agujas o tijeras se aconseja una limpieza manual: ver punto "C").

a.- Limpieza en la pila de ultrasonido

Los instrumentos tienen que estar en la pila el tiempo necesario recomendado por el fabricante para efectuar el ciclo del lavado, generalmente de 5 a 10 minutos.

Los instrumentos con bisagras o juntas (articulaciones) tienen que sumergirse en la pila en posición abierta.

Asegurarse de que las hojas afiladas de las tijeras, bisturíes para gingivectomía, curetas, etc. no estén en contacto con otros instrumentos.

Todos los instrumentos deben estar completamente sumergidos en la solución de lavado.

No poner instrumentos de diferentes metales (acero inoxidable, instrumentos cromados, latón, etc.) en el mismo ciclo de lavado.

Cambiar a menudo la solución para el lavado, como mínimo todas las veces que lo recomienda el fabricante de la pila de ultrasonidos.

Enjuagar concienzudamente los instrumentos con agua corriente tras lavado con ultrasonidos para quitar los residuos de la solución de lavado.

b.- Limpieza con lavadora

Seguir las indicaciones del fabricante. Asegurarse de que los instrumentos hayan sido lubricados tras el último ciclo de lavado y antes del ciclo de esterilización.

c.- Limpieza manual

La mayor parte de los fabricantes de instrumentos indican el lavado con los ultrasonidos como el modo mejor y más eficaz para limpiar los instrumentos quirúrgicos, especialmente los que tienen bisagras, cierres y en general articulaciones. Si la limpieza con los ultrasonidos no es posible, se aconseja usar el método siguiente:

- Usar cepillos rígidos de plástico, nylon, etc.
- Cepillar concienzudamente los instrumentos más delicados y, si es posible, enjuagar, limpiar y esterilizar estos instrumentos separadamente.
- Verificar que toda la superficie de estos instrumentos esté limpia.
- Tras haber cepillado los instrumentos, enjuagarlos bajo el chorro de agua corriente.
- Durante el enjuagado abrir y cerrar las tijeras, las pinzas hemostáticas, los porta agujas y los demás instrumentos con bisagras o juntas y asegurarse de que las partes internas de las bisagras estén perfectamente enjuagadas como la superficie externa del instrumento.

SECADO, LUBRIFICACIÓN E INSPECCIÓN

Tras las operaciones de limpieza y de enjuagado, los instrumentos quirúrgicos tienen que ser secados perfectamente.

Todos los instrumentos con juntas o bisagras (acción "metal contra metal") como tijeras, pinzas hemostáticas, porta agujas, fórceps de extracción, etc., tienen que ser lubricados. Se aconsejan lubricantes específicos para el instrumental quirúrgico. No usar aceites o lubricantes industriales.

A este punto es buena norma inspeccionar el estado de cada instrumento y verificar el funcionamiento según el uso específico. Controlar y asegurarse de que:

- Las hojas de las tijeras estén lisas de arriba abajo y de que, una vez cerradas, no hagan juego. Probar las tijeras cortando gasa muy fina. Tres cuartas parte de la hoja tienen que cortar la gasa sin retenerla.

- Las puntas de las pinzas estén al mismo nivel.
- Las pinzas hemostáticas y los porta agujas no dejen pasar la luz entre las puntas cuando estén cerradas, se abran y cierren fácilmente y que las bisagras no estén demasiado flojas.
- Controlar el desgaste de la porta agujas sobre la superficie interna de las puntas.
- Las cánulas metálicas de aspiración estén bien limpias en su interior.
- Los instrumentos cortantes y los bisturíes tengan las hojas bien afiladas y no estropeadas.

ESTERILIZACIÓN EN AUTOCLAVE

Tras haber enjuagado, limpiado, secado, lubricado e inspeccionado los instrumentos, éstos pueden ser preparados para la esterilización separadamente o en serie.

Instrumentos individuales:

Las bolsas especiales monouso son el ideal para contener los instrumentos. Asegurarse de que las bolsas que contendrán los instrumentos con cierres y articulaciones (pinzas hemostáticas, porta agujas, etc.) sean lo bastante grandes como para contener los citados instrumentos en posición abierta.

Instrumentos en serie:

Poner los instrumentos en los especiales cestos o bandejas de acero inoxidable. Poner los instrumentos más pesados en la parte inferior cuando sean necesarias varias bandejas.

No cerrar nunca los instrumentos durante el ciclo en autoclave. Un instrumento cerrado no estará nunca esterilizado, ya que el vapor no puede penetrar en la parte de cierre a contacto "metal contra metal". En el instrumento podría además romperse en la parte de la bisagra a causa de la expansión del metal debida al calor durante el ciclo del autoclave.

No cargar demasiado la cámara del autoclave ya que algunos instrumentos podrían formar "zonas de sombra" sobre otros en los que el vapor no penetraría.

ATENCIÓN

Al final del ciclo de esterilización - antes del ciclo de secado- abrir ligeramente la portezuela del autoclave y preceder con el ciclo desecado según las instrucciones del fabricante. Si la portezuela del autoclave se abre completamente antes del ciclo de secado, el aire frío de la habitación entraría en la cámara del autoclave causando la formación de condensación sobre los instrumentos y de consecuencia aparecerían las manchas de agua que vemos a menudo en los mismos.

ESTERILIZACIÓN EN FRÍO:

La mayor parte de las soluciones para la esterilización en frío esterilizan los instrumentos completamente tras 10 horas de inmersión. Esta acción química prolongada puede ser más perjudicial para los instrumentos que el ciclo normal de 20 minutos en autoclave.

Si los instrumentos tienen necesidad de ser simplemente "desinfectados", el proceso en frío es adecuado, ya que la desinfección tiene lugar en 10 minutos solamente.

Recuerde bien la diferencia entre:

ESTÉRIL - término absoluto (ningún organismo logra sobrevivir) y

DESINFECTADO - perfectamente limpio.

Usen siempre la técnica más adecuada de esterilización/limpieza de los instrumentos según el uso que se haga posteriormente de ellos.

Recuerden que la esterilización de los instrumentos no sustituye la limpieza de los mismos.

Recomendamos no volver a usar ni esterilizar los artículos de un solo uso.

Si se tratan en el modo correcto los instrumentos contruidos con las modernas aleaciones inoxidables pueden durar muchos años.

INDICAZIONI PER LA CURA, PULITURA E LA STERILIZZAZIONE DELLO STRUMENTARIO CHIRURGICO RISTERILIZZABILE

Misure preventive anticorrosione

- 1) Raggruppare accuratamente gli strumenti correttamente confezionati e sterilizzati prima dell'operazione; selezionarli secondo l'intervento. Verificare sempre che la confezione esterna sia integra e che lo strumento stesso non sia danneggiato.
- 2) Assicurarsi tramite l'indicatore di sterilizzazione collocato all'interno del vaglio che il contenuto sia stato sterilizzato.
- 3) Disporre gli strumenti seguendo l'ordine di utilizzo durante l'operazione; lasciare gli strumenti non necessari nel vaglio; predisporre gli strumenti solo immediatamente prima dell'operazione.
- 4) Nel corso dell'operazione rimuovere dagli strumenti sangue ed altri materiali biologici; dopo l'uso, riporre gli strumenti nel corretto alloggiamento.
- 5) Risciacquare opportunamente gli strumenti cavi, al fine di evitare l'adesione di sangue e polvere d'osso.
- 6) Per la pulitura degli strumenti utilizzare una soluzione lattata o una soluzione salina, ma non immergerli nelle suddette soluzioni.
- 7) Iniziare l'operazione di pulitura subito dopo l'intervento. Strumenti utilizzati su pazienti con possibili infezioni: smaltire in modo analogo, eliminando sangue, polvere d'osso parti di tessuto in eccesso.
- 8) Pulire gli strumenti in un luogo previsto nell'ambito della sala operatoria.

Nel caso in cui gli strumenti vadano collocati direttamente nella centrale di sterilizzazione, è necessario dapprima coprirli, per evitare il rischio di contaminazione ai danni del personale o dell'ambiente circostante.

Disinfezione

Durante l'uso di disinfettanti chimici è necessario osservare scrupolosamente le indicazioni del produttore; utilizzare le soluzioni sempre previa diluizione. Nella fase termica di disinfezione con acqua bollente assicurarsi che l'acqua sia priva di corpi estranei.

Pulitura

Indipendentemente dal metodo utilizzato per la pulitura (meccanico o manuale) si raccomanda di verificare attentamente quale detergente vada utilizzato con ciascun metodo. Valori pH consigliati: tra 7,0 e 8,5.

1) Pulitura meccanica

Osservare scrupolosamente le istruzioni d'uso fornite dal produttore della macchina pulitrice. Predisporre gli

strumenti per la pulitura meccanica. Tutti gli strumenti appuntiti e delicati dovrebbero essere puliti manualmente.

Non sovraccaricare i vagli, mettere gli strumenti pesanti sul fondo del vaglio. Se necessario, immergere e risciacquare gli strumenti molto sporchi (strumenti cavi), prima di collocarli nella lavatrice.

2) Pulitura ad ultrasuoni

(fa parte dei metodi di pulitura meccanica)

Prima di inserire uno strumento nel bagno ad ultrasuoni, rimuovere i materiali organici in eccesso. I bagni ad ultrasuoni sono consigliati per le filettatrici o gli strumenti con solchi profondi. L'ultrasuono deve essere seguito da un programma di risciacquo normale.

3) Pulitura manuale

Richiede diverse spazzole in nylon, una canna da soffio ed un ugello da soffio/ un dispositivo ad aria compressa pulito, detersivi e solventi come per la pulitura meccanica.

Per gli additivi di pulitura osservare le indicazioni fornite dal produttore.

Per la pulitura degli strumenti dotati di cannula, passare più volte lo spazzolino di nylon attraverso la cannula eseguendo movimenti rotatori (non utilizzare spazzole in lana d'acciaio/metallo) fino alla completa rimozione dei residui eliminabili con questo metodo.

Soffiare poi con aria compressa nella cannula.

4) Asciugatura

Ogni strumento deve essere asciugato completamente sia internamente che esternamente per evitare la formazione di ruggine o malfunzionamenti.

Indicazioni per la sterilizzazione della strumentazione

Pulire immediatamente ed asciugare bene gli strumenti usati, non utilizzare detersivi e disinfettanti con additivi fortemente acidi o alcalini (ad es. soda, soda caustica o acidi)!

Sterilizzare la strumentazione solo a vapore A 134°!

Prima della sterilizzazione, assicurarsi che gli strumenti siano perfettamente funzionanti ed integri. La sterilizzazione non sostituisce la pulitura.

DIAGNOSTIK DIAGNOSTICS DIAGNOSTICO DIAGNOSTICA	7 - 12
SKALPELLE SCALPELS BISTURÍES BISTURI	13 - 18
SCHEREN SCISSORS TIJERAS FORBICI	19 - 48
PINZETTEN FORCEPS PINZAS PINZETTE	49 - 76
KLEMMEN CLAMPS PINZAS PINZE	77 - 92
NADELHALTER NEEDLE HOLDERS PORTA-AGUJAS PORT'AGHI	93 - 100
HAKEN HOOKS GANCHOS UNCINI	101 - 118
SPREIZER SPREADER SEPARADORES DIVARICATORI	119 - 160
ZANGEN FORCEPS PINZAS PINZE	161 - 174
SCHÄDELHALTER, DRAHTSÄGEN, TREPHINEN SKULL HOLDER, WIRE SAWS, TREPHINE CRÁNEO TITULAR, ALAMBRE DE SIERRAS, TREPANO SKULL TITOLARE, SEGHE A FILO, TRAPANO	175 - 182
LÖFFEL, MEISSEL CURETTES, CHISELS CUCHARILLAS, CINCELES CUCCHIAI, SCALPELLI	183 - 204
ELEVATORIEN, RASPATORIEN, DISSEKTOREN ELEVATORS, RASPATORIES, DISSECTORS ELEVADORES, PERIOSTÓTOMOS, DISECTORES ELEVATORI, PERIOSTOTOMI, DISSETTORI	205 - 228

SAUGROHRE SUCTION TUBES TUBOS DE ASPIRACIÓN TUBI D'ASPIRAZIONE	229 - 236
LAMINEKTOMIE LAMINECTOMY LAMINECTOMIA LAMINECTOMIA	237 - 246
MIKRO-RUNDGRIFFINSTRUMENTE MICRO INSTRUMENTS WITH ROUND HANDLE INSTRUMENTOS PARA MICROCIRUGÍA CON MANGOS REDONDOS STRUMENTI PER MICROCHIRURGIA CON MANICO ROTONDO	247 - 258
HYPOPHYSEKTOMIE HYPOPHYSECTOMY HIPOFISECTOMIA IPOFISECTOMIA	259 - 272
HIRNSPATEL BRAIN SPATULAS ESPÁTULAS CEREBRALES SPATOLE CEREBRALI	273 - 280
STANZEN PUNCHES PINZAS SACABOCADO PINZE LAMINOTOMO	281 - 288
CLIPS CLIPS CLIPS CLIPS PER ANEURISMA	289 - 320
BOHRAPPARATE BONE HAND DRILLS PERFORADORES DE MANO PERFORATORI A MANO	321 - 326
BIPOLARE KOAGULATION BIPOLAR COAGULATION COAGULACIÓN BIPOLAR COAGULAZIONE BIPOLARE	327 - 336
SÄTZE SET SET SET	337 - 344
NUMMERNVERZEICHNIS NUMERICAL INDEX INDICE NUMÉRICO INDICE NUMERICO	345 - 353
ALPHABETISCHER INDEX ALPHABETICAL INDEX INDICE ALFABÉTICO INDICE ALFABETICO	355 - 377

Reda Instrumente GmbH
Gänsäcker 34 - P.O. Box 131
D-78532 Tuttlingen



DIAGNOSTIK

DIAGNOSTICS

DIAGNÓSTICO

DIAGNOSTICA



www.Reda-Instrumente.de

Perkussionshämmer
Percussion Hammers
Martillos de percusión
Martelli da percussione



TAYLOR - USA Mod.
03288-17 17 cm, 6 ³/₄"
03288-20 20 cm, 8"



BABINSKY
03292-22 22 cm, 8 ³/₄"



TROEMNER
03294-24 24 cm, 9 ¹/₂"



DEJERINE
03304-20 20 cm, 8"



BERLINER
03306-17 17 cm, 6 ³/₄"



BUCK
03308-18 18 cm, 7"

Hämmer
Bone Hammers and Mallets
Martillos y mazos
Martelli

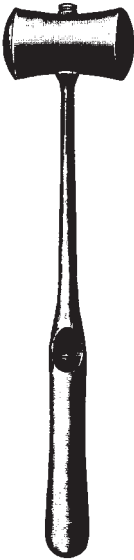

WILLIGER
33691-34
24 cm, 9 1/2"
340 g

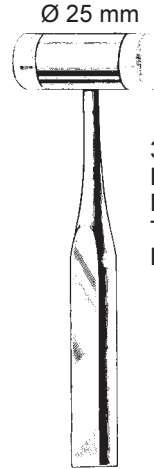

33694-03
Ersatzbacken
Nylon Caps
Tapas de repuesto
Battenti di ricambio

33694-01
18,5 cm, 7 1/4"
135 g

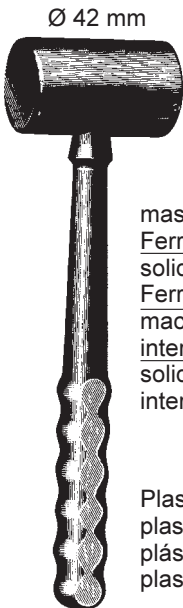

massiv, mit auswechselbaren
Ferrozellbacken
solid, with interchangeable
Ferrozell jaws
macizo, con tapas
intercambiables de Ferrozell
solido, con placche
intercambiabili in Ferrozell

Plastik
plastic
plástico
plastica

33695-40
26 cm, 10 1/4"
400 g



33699-17
26,5 cm, 10 1/2"
530 g

Hämmer
 Bone Hammers and Mallets
 Martillos y mazos
 Martelli

Ø 30 mm



33700-01-01
 Ersatzbacken
 Nylon Caps
 Tapas de repuesto
 Battenti di ricambio

33700-01
 24,5 cm, 9 3/4" 215 g

Ø 30 mm



COTTLE
 33700-05
 18 cm, 7" 240 g

Ø 40 mm



OMBREDANNE
 33700-07
 25 cm, 10" 700 g

Ø 35 mm



WAGNER
 33709-00
 24,5 cm, 9 3/4" 215 g

- komplett mit:
- | | |
|-------------------------|----------|
| 1 Paar Metallbacken | 33709-01 |
| 1 Paar Kunststoffbacken | 33709-02 |
| 1 Schlüssel | 33709-03 |
- complete with:
- | | |
|-------------------------|----------|
| 1 pair of metal discs | 33709-01 |
| 1 pair of plastic discs | 33709-02 |
| 1 wrench | 33709-03 |
- completo con:
- | | |
|------------------------------|----------|
| 1 par de mandibulas de metal | 33709-01 |
| 1 par de zapatos de plástico | 33709-02 |
| 1 llave | 33709-03 |
- completo di battenti:
- | | |
|------------------------------|----------|
| 1 paio di ganasce di metallo | 33709-02 |
| 1 paio di dischi di plastica | 33709-02 |
| 1 chiave | 33709-03 |

Prüf- und Meßinstrumente, Stimmgabel
 Examination and Measuring Instruments, Tuning Fork
 Instrumentos para exámenes y medición, Diapason
 Strumenti per esaminare e misurare, Diapason



03360-01
 Messbereich bis 150 mm
 measuring range up to 150 mm
 campo de medición hasta 150 mm
 calibro con scala fino a 150 mm



WARTENBERG
 03320-19
 19 cm, 7 1/2"

aus Stahl
 of steel
 de acero
 di acciaio



03350-15
 1,5 m 0.6"

mm & Inch

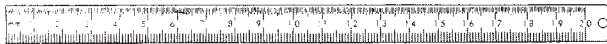

Metall		
03340-10	10 cm	4"
03340-15	15 cm	6"
03340-20	20 cm	8"
03340-30	30 cm	12"
03340-50	50 cm	20"



45075-00

Reda Instrumente GmbH
Gänsäcker 34 - P.O. Box 131
D-78532 Tuttlingen



SKALPELLE

SCALPELS

BISTURÍES

BISTURI



www.Reda-Instrumente.de

Skalpell-Griffe
Scalpel Handles
Mangos de bisturios
Manici per lame bisturi

passend zu den Klingen
for blades
para las hojas
per lame bisturi

Ⓐ No. 10, 11, 12, 13, 14, 15, 16, 17, 18, 19



07103-00
Fig. 3

Ⓐ



07103-01
Fig. 3 grad.

Ⓐ



07106-01
14,5 cm 5 3/4"

Ⓐ

Skalpelli-Griffe
 Scalpel Handles
 Mangos de bisturíes
 Manici per lame bisturi

passend zu den Klängen
 for blades
 para las hojas
 per lame bisturi

Ⓐ No. 10, 11, 12, 13, 14, 15, 16, 17, 18, 19



07107-00
 Fig. 7
 Ⓐ



07107-01
 Fig. 7K
 Ⓐ



07109-10 10,0 cm, 4"
 07109-13 13,0 cm, 5"
 07109-15 15,5 cm, 6"



07161-00 07162-00



07165-00 07167-00

Packung mit 10 Stück
 box of 10
 en cajas de 10 pzas
 confezione di 10

Skalpell-Griffe
Scalpel Handles
Mangos de bisturíes
Manici per lame bisturi



CASPAR



93380-13
135 mm / 5 1/2"



93380-15
155 mm / 6"



93380-18
180 mm / 7"



93380-20
200 mm / 8"



LANDOLT

93385-21 210 mm / 8 1/4"
93385-25 250 mm / 10"

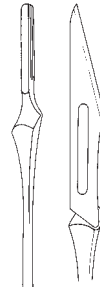

horizontal

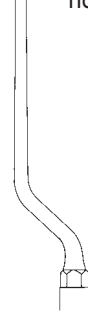

LANDOLT

93390-21 210 mm / 8 1/4"



Klingenbrecher
Blade Breakers
Rompe-hojas
Rompi lama di rasoio



TROUTMAN-CHRIS
07290-09 9 cm, 3 1/2"



REDA
07291-11 11 cm, 4 3/8"



CASTROVIEJO
07294-13 13 cm, 5 1/8"

Reda Instrumente GmbH
Gänsäcker 34 - P.O. Box 131
D-78532 Tuttlingen

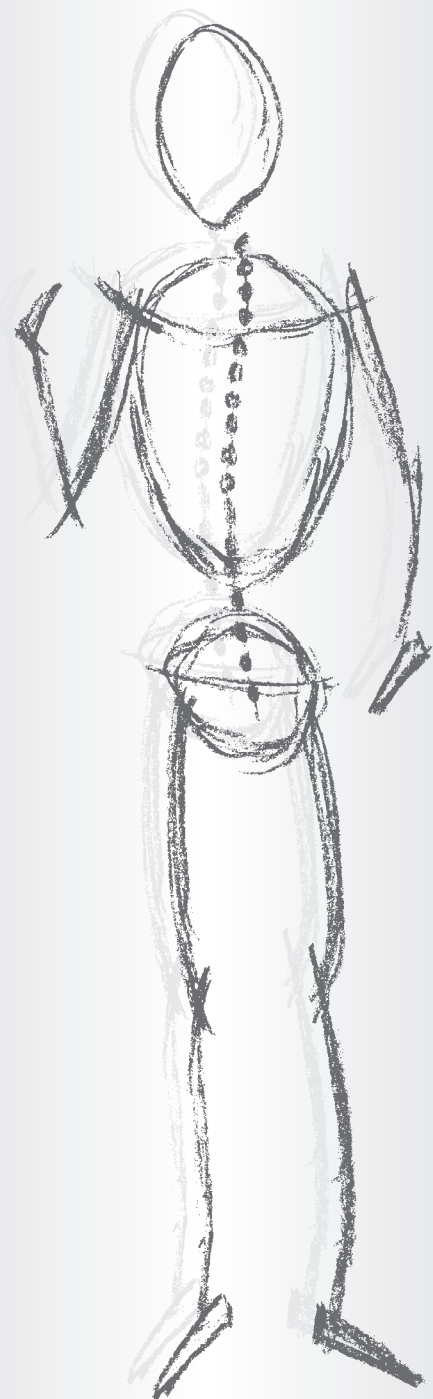

SCHEREN

SCISSORS

TIJERAS

FORBICI



www.Reda-Instrumente.de

Chirurgische Scheren
 Operating Scissors
 Tijeras para cirugía
 Forbici per chirurgia



STANDARD —
 09102-13 13,0 cm, 5"
 09102-14 14,5 cm, 5 3/4"
09104-14 TC
 09102-16 16,5 cm, 6 1/2"
 09102-18 18,5 cm, 7 1/4"



STANDARD —
 09110-13 13,0 cm, 5"
 09110-14 14,5 cm, 5 3/4"
09114-14 TC
 09110-16 16,5 cm, 6 1/2"
 09110-18 18,5 cm, 7 1/4"



STANDARD —
 09120-13 13,0 cm, 5"
 09120-14 14,5 cm, 5 3/4"
09124-14 TC
 09120-16 16,5 cm, 6 1/2"
 09120-18 18,5 cm, 7 1/4"



STANDARD —
 09103-13 13,0 cm, 5"
 09103-14 14,5 cm, 5 3/4"
09105-14 TC
 09103-16 16,5 cm, 6 1/2"
 09103-18 18,5 cm, 7 1/4"



STANDARD —
 09111-13 13,0 cm, 5"
 09111-14 14,5 cm, 5 3/4"
09115-14 TC
 09111-16 16,5 cm, 6 1/2"
 09111-18 18,5 cm, 7 1/4"



STANDARD —
 09121-13 13,0 cm, 5"
 09121-14 14,5 cm, 5 3/4"
09125-14 TC
 09121-16 16,5 cm, 6 1/2"
 09121-18 18,5 cm, 7 1/4"

Chirurgische Scheren
Operating Scissors
Tijeras para cirugía
Forbici per chirurgia

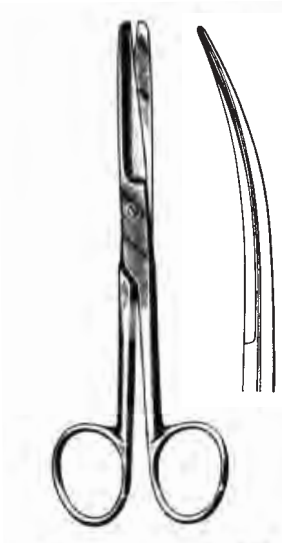

DEAVER
09130-14 14 cm 09131-14
5 1/2"

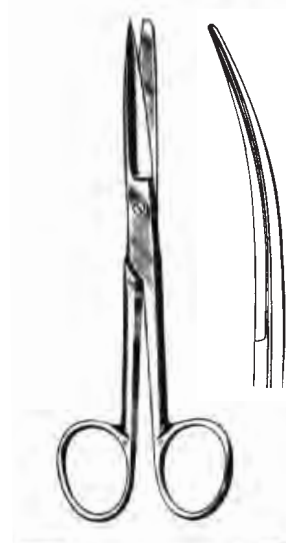

DEAVER
09140-14 14 cm 09141-14
5 1/2"

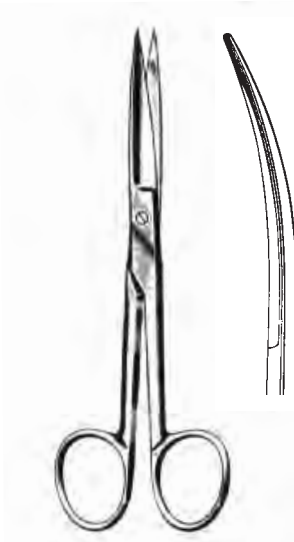

DEAVER
09150-14 14 cm 09151-14
5 1/2"



KELLY
09540-16 09541-16
09542-16 TC 09543-16 TC
16 cm, 6 1/4"

Präparierscheren
 Dissecting Scissors
 Tijeras de disección
 Forbici per dissezione



MAYO

09160-14	14,5 cm	09161-14
09164-14 TC	14,5 cm	09165-14 TC
	5 ³ / ₄ "	
09160-17	17,0 cm	09161-17
09164-17 TC	17,0 cm	09165-17 TC
	6 ³ / ₄ "	
09160-23	23,0 cm	09161-23
09164-23 TC	23,0 cm	09165-23 TC
	9"	



MAYO-STILLE

09170-15	15,0 cm	09171-15
09174-15 TC	15,0 cm	09175-15 TC
	6"	
09170-17	17,0 cm	09171-17
09174-17 TC	17,0 cm	09175-17 TC
	6 ³ / ₄ "	
09170-21	21,0 cm	09171-21
09174-21 TC	21,0 cm	09175-21 TC
	8 ¹ / ₄ "	



LEXER
 09190-16

09194-16 TC
 16 cm, 6 ¹/₄"



LEXER
 09191-16

09195-16 TC
 16 cm, 6 ¹/₄"

Präparierscheren
Dissecting Scissors
Tijeras de disección
Forbici per dissezione



- METZENBAUM**
- 09280-12 **09284-12 TC**
12 cm 4 3/4"
 - 09280-15 **09284-15 TC**
15 cm 6"
 - 09280-18 **09284-18 TC**
18 cm 7"
 - 09280-20 **09284-20 TC**
20 cm 8"
 - 09280-23 **09284-23 TC**
23 cm 9"
 - 09280-25 **09284-25 TC**
25 cm 10"



- METZENBAUM**
- 09281-12 **09285-12 TC**
12 cm 4 3/4"
 - 09281-15 **09285-15 TC**
15 cm 6"
 - 09281-18 **09285-18 TC**
18 cm 7"
 - 09281-20 **09285-20 TC**
20 cm 8"
 - 09281-23 **09285-23 TC**
23 cm 9"
 - 09281-25 **09285-25 TC**
25 cm 10"



- METZENBAUM FINO**
- 09282-15 **09286-15 TC**
15 cm 6"
 - 09282-18 **09286-18 TC**
18 cm 7"
 - 09282-20 **09286-20 TC**
20 cm 8"
 - 09282-23 **09286-23 TC**
23 cm 9"
 - 09282-25 **09286-25 TC**
25 cm 10"



- METZENBAUM FINO**
- 09283-15 **09287-15 TC**
15 cm 6"
 - 09283-18 **09287-18 TC**
18 cm 7"
 - 09283-20 **09287-20 TC**
20 cm 8"
 - 09283-23 **09287-23 TC**
23 cm 9"
 - 09283-25 **09287-25 TC**
25 cm 10"

Präparierscheren
Dissecting Scissors
Tijeras de disección
Forbici per dissezione



METZENBAUM BLACK



09281-15B
14,5 cm, 5 ³/₄"



09281-18B
18 cm, 7"



09281-20B
20 cm, 8"



09283-18B
18 cm, 7"

fein
delicate
fina
delicate



09283-20B
20 cm, 8"

fein
delicate
fina
delicate

Präparierscheren
Dissecting Scissors
Tijeras de disección
Forbici per dissezione



BABY-METZENBAUM BLACK
09283-15B
14,5 cm, 5 ³/₄"



BLACK
09371-11B
11,5 cm, 4 ¹/₂"

Präparierscheren
 Dissecting Scissors
 Tijeras de disección
 Forbici per dissezione

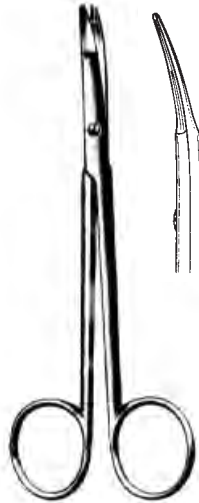

KILNER

- 09310-12 12 cm, 4 3/4" **09314-12 TC**
- 09310-15 15 cm, 6"
- 09312-12 12 cm, 4 3/4"



fein
 delicate
 fina
 delicate

JAMESON WERBER
 09322-13 13 cm, 5"



REYNOLDS

- 09321-15 15 cm, 6"
- 09321-18 18 cm, 7"
- **09325-15 TC** 15 cm, 6"

Feine Scheren, Nerv-Präparierscheren
 Delicate Scissor, Nerve Dissecting Scissors
 Tijeras finas, Tijeras de diseccion para nervios
 Forbici delicate per preparazione nervi

Iris - Standard



abgewinkelt
 angled
 angulada
 angolata

09340-09	9 cm, 3 1/2"	09341-09	09346-11	11 cm, 4 3/8"
09340-10	10 cm, 4"	09341-10		
09340-11	11 cm, 4 3/8"	09341-11		
09344-11 TC	11 cm, 4 3/8"	09345-11 TC		

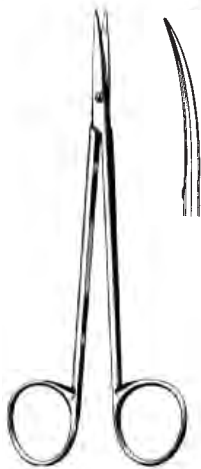

09582-15 09583-15
 15 cm, 6"



TOENNIS-ADSON
 09610-18
 18 cm, 7"

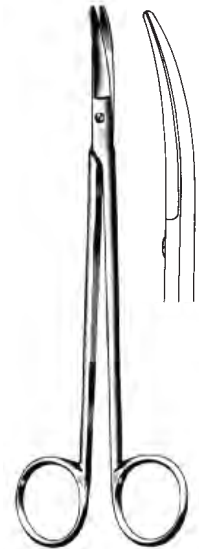

TOENNIS-ADSON
 09611-18
 18 cm, 7"

Feine Scheren
Delicate Scissors
Tijeras finas
Forbici delicate



— GRADLE —
09350-09 09351-09
9,5 cm, 3 3/4"



— —
09352-09 09353-09
9,5 cm, 3 3/4"



09360-11



09362-11



STEVENS
11 cm, 4 3/8"



09361-11



09363-11

Gefäßscheren
 Vascular Scissors
 Tijeras vasculares
 Forbici vascolari

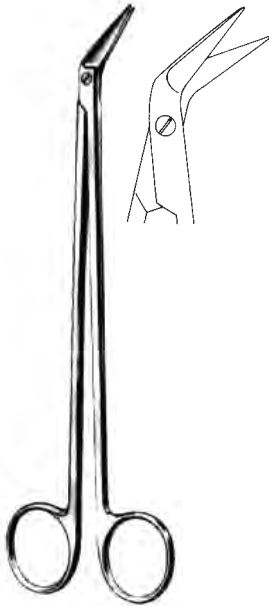

POTTS-DE MARTEL
 09473-21
 21 cm, 8 1/4"



MILLS
 09474-22
 22 cm, 8 3/4"



DIETRICH



09475-25
 09476-25 TC
 18 cm, 7"

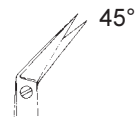

09475-45
 09476-45 TC
 18 cm, 7"

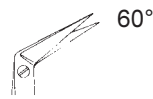

09475-60
 09476-60 TC
 17,5 cm, 6.9"



09475-90
 09476-90 TC
 17 cm, 6 3/4"



09475-00
 09476-00 TC
 17 cm, 6 3/4"

Gefäßscheren
 Vascular Scissors
 Tijeras vasculares
 Forbici vascolari



DIETRICH
 09477-01
 17 cm, 6 3/4"



POTTS-SMITH
 09480-18
 18,5 cm, 7 1/4"

Scheren mit Hartmetalleinsätzen
 Scissors with Tungsten Carbide
 Tijeras con carburo de tungsteno
 Forbici con carburo di tungsteno



09478-25 **09478-45** **09478-60**
 19 cm 19 cm 19 cm
 7 1/2" 7 1/2" 7 1/2"

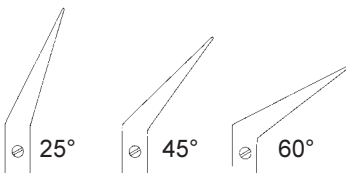

09479-25 **09479-45** **09479-60**
 23 cm 23 cm 23 cm
 9" 9" 9"



DE BAKEY
 (POTTS-SMITH)

Gefäßscheren
 Vascular Scissors
 Tijeras vasculares
 Forbici vascolari

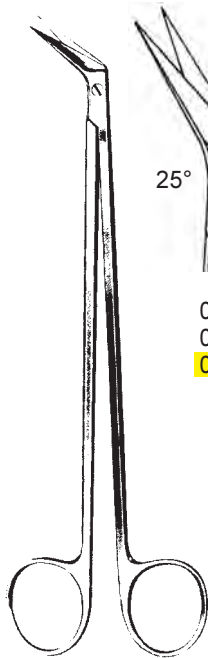

POTTS-SMITH
 19 cm, 7 1/2"

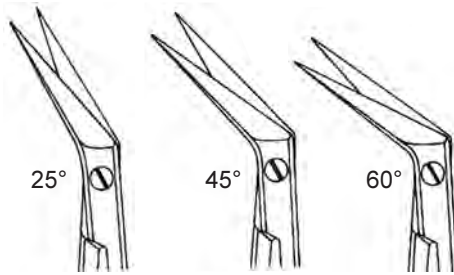

- | | | |
|-------------|-------------|-------------|
| 09480-25 | 09480-40 | 09480-60 |
| 09480-25 SC | 09480-40 SC | 09480-60 SC |
| 09481-25 TC | 09481-40 TC | 09481-60 TC |

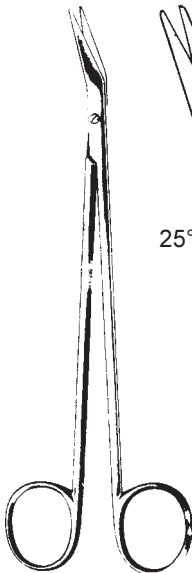

DE BAKEY

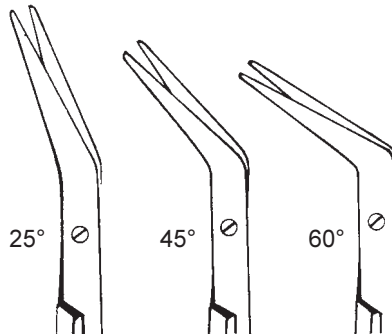

- | | | | |
|----------|----------|----------|---------------|
| 09490-16 | 09491-16 | 09492-16 | 16 cm, 6 1/4" |
| 09490-23 | 09491-23 | 09492-23 | 23 cm, 9" |
| 09490-28 | 09491-28 | 09492-28 | 28 cm, 11" |

Gefäßscheren
Vascular Scissors
Tijeras vasculares
Forbici vascolari

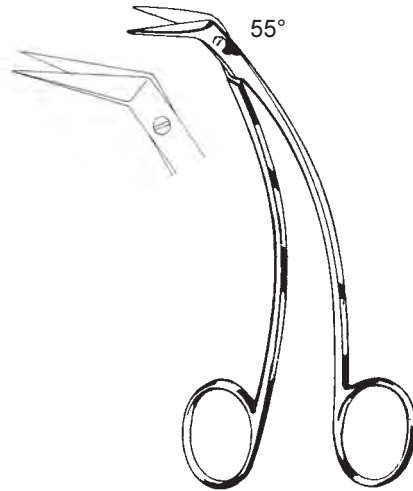

FAVALORO
09496-15 15 cm, 5.9"

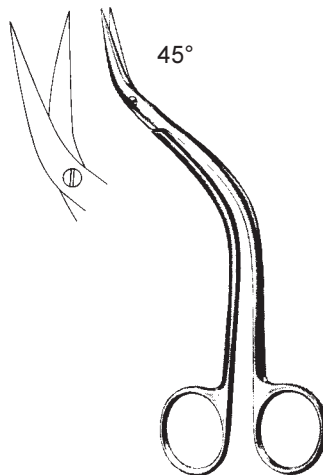

DE BAKEY
09497-15 15,5 cm, 6"

Trigeminusscheren
Trigeminal Scissors
Tijera para trigémino
Forbici per trigemino



STRULLY
09601-22
22 cm, 8 3/4"



DANDY
09617-17
17 cm, 6 3/4"



gezahnt
toothed
dentada
dentate

OLIVECRONA
09620-23
23 cm, 9"

Duraschere
Dura Scissors
Tijeras para duramadre
Forbici per dura-madre



SCHMIEDEN-TAYLOR
09619-17
17 cm, 6 ³/₄"

Draht-, Blehschere
Wire and plate scissors
Tijeras para alambre y láminas
Forbici per filo di metallo e lamiera



UNIVERSAL
09831-12 12 cm, 4 ³/₄"
09835-12 TC 12 cm, 4 ³/₄"

Mikro-Federschere, bajonettförmig
Micro Scissors (Spring Type), bayonet-shaped
Micro tijeras, forma bayoneta
Micro forbici a baionetta



190 mm
7 1/2"



10120-18



10121-18



10122-18



10123-18

Mikro-Federscheren
Micro Scissors (Spring Type)
Micro tijeras
Micro forbici



CASTROVIEJO
100 mm
4"



10133-10
spitz
sharp
agudo
acuta



10135-10
stumpf
blunt
romo
smussa

Mikro-Federscheren
Micro Scissors (Spring Type)
Micro tijeras
Micro forbici



1/1

VANNAS
80 mm
3 1/8"



1/1

10140-08



1/1

10141-08



1/1

10143-08

Mikro Scheren
 Micro Scissors
 Micro tijeras
 Micro Forbice



10 mm

11 cm
 4 3/8"

10202-11

10203-11

14,5 cm
 5 3/4"

10202-14
 10202-14T

10203-14
 10203-14T

18 cm
 7"

10202-18
 10202-18T

10203-18
 10203-18T

21 cm
 8 1/4"

10202-21
 10202-21T

10203-21
 10203-21T

23 cm
 9"

10202-23

10203-23

T = Titan, titanium, titanio, titanio

Mikro Scheren
Micro Scissors
Micro tijeras
Micro Forbice



18 cm 7"



25°

10220-25

10220-25T

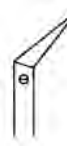

45°

10220-45

10220-45T



60°

10220-60

10220-60T



90°

10220-90

10220-90T



125°





10220-00

10220-00T

T = Titan, titanium, titanio, titanio

Mikro Scheren
 Micro Scissors
 Micro tijeras
 Micro Forbice

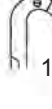

	11 cm 4 3/8"	14,5 cm 5 3/4"	18 cm 7"	21 cm 8 1/4"	23 cm 9"
 25°	10226-11	10226-14	10226-18 10226-18T	10226-21	10226-23
 45°	10227-11	10227-14	10227-18 10227-18T	10227-21	10227-23
 60°	10228-11	10228-14	10228-18 10228-18T	10228-21	10228-23
 90°	10229-11	10229-14	10229-18 10229-18T	10229-21	10229-23
 125°	10230-11	10230-14	10230-18 10230-18T	10230-21	10230-23

T = Titan, titanium, titanio, titanio

Mikro-Federschere, bajonettförmig
 Micro Scissors (Spring Type), bayonet-shaped
 Micro tijeras, forma bayoneta
 Micro forbici a baionetta



YASARGIL



93094-16 165 mm / 6 1/2"
 93094-20 200 mm / 8"



93095-16 165 mm / 6 1/2"
 93095-20 200 mm / 8"



93097-20 200 mm / 8"



93098-20 200 mm / 8"
 Präparierscheren
 Dissecting Scissors
 Tijeras de disección
 Forbici per dissezione



93099-20 200 mm / 8"
 Präparierscheren
 Dissecting Scissors
 Tijeras de disección
 Forbici per dissezione

Mikro-Federscheren, bajonettförmig
 Micro Scissors (Spring Type), bayonet-shaped
 Micro tijeras, forma bayoneta
 Micro forbici a baionetta



93100-22	225 mm / 9"	YASARGIL
93101-22	225 mm / 9"	Schneiden gezahnt toothed blades ramas dentadas tagli dentellati



93102-22	225 mm / 9"	VANNAS
----------	-------------	--------



93103-22	225 mm / 9"	YASARGIL
93103-24	245 mm / 9 3/4"	



93105-22	225 mm / 9"	VANNAS
----------	-------------	--------



93107-22	225 mm / 9"	YASARGIL
----------	-------------	----------



93108-22	225 mm / 9"	YASARGIL
		Präparierscheren Dissecting Scissors Tijeras de disección Forbici per dissezione



93109-22	225 mm / 9"	YASARGIL
		Präparierscheren Dissecting Scissors Tijeras de disección Forbici per dissezione

Mikro-Federschere, bajonettförmig
Micro Scissors (Spring Type), bayonet-shaped
Micro tijeras, forma bayoneta
Micro forbici a baionetta



NAGEL

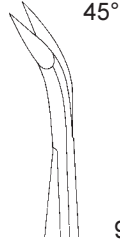

45°

93111-20 200 mm / 8"

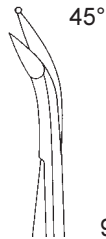

45°

93113-20 200 mm / 8"
mit Kopf
with probe-pointed blade
punta abotonada
punta bottonuta



125°

93115-19 190 mm / 7 1/2"

Mikro-Federscheren
 Micro Scissors (Spring Type)
 Micro tijeras
 Micro forbici



- | | | |
|----------|-------------------|----------|
| 93180-12 | 120 mm / 4 3/4" | |
| 93180-16 | 160 mm / 6 1/4" | |
| 93182-16 | 160 mm / 6 1/4" | MILLES |
| | Schneiden gezahnt | ← |
| | toothed blades | |
| | ramas dentadas | |
| | tagli dentellati | |
| 93180-18 | 185 mm / 7 1/4" | YASARGIL |



- | | | |
|----------|-------------------|----------|
| 93181-12 | 120 mm / 4 3/4" | |
| 93181-16 | 160 mm / 6 1/4" | |
| 93183-16 | 160 mm / 6 1/4" | MILLES |
| | Schneiden gezahnt | ← |
| | toothed blades | |
| | ramas dentadas | |
| | tagli dentellati | |
| 93181-18 | 185 mm / 7 1/4" | JACOBSON |



- | | | |
|----------|-----------------|--------|
| 93190-12 | 120 mm / 4 3/4" | VANNAS |
| 93190-16 | 160 mm / 6 1/4" | |



- | | | |
|----------|-----------------|--------|
| 93191-12 | 120 mm / 4 3/4" | VANNAS |
| 93191-16 | 160 mm / 6 1/4" | |



- | | | |
|----------|-------------------|--------|
| 93192-13 | 130 mm / 5 1/8" | BIEMER |
| | Venenschere | |
| | Vein Scissors | |
| | Tijera para venas | |
| | Forbice per vene | |



- | | | |
|----------|-----------------|--------|
| 93193-12 | 120 mm / 4 3/4" | VANNAS |
|----------|-----------------|--------|

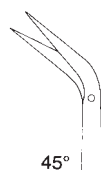

- | | | |
|----------|-----------------|----------------|
| 93195-18 | 185 mm / 7 1/4" | POTTS-YASARGIL |
|----------|-----------------|----------------|

45°

Mikro-Federscheren
 Micro Scissors (Spring Type)
 Micro tijeras
 Micro forbici

93210-12	120 mm / 4 3/4"	
93210-16	160 mm / 6 1/4"	
93212-16	160 mm / 6 1/4"	MILLES
	Schneiden gezahnt	←
	toothed blades	
	ramas dentadas	
	tagli dentellati	
93210-18	185 mm / 7 1/4"	YASARGIL



93211-12	120 mm / 4 3/4"	
93211-16	160 mm / 6 1/4"	
93213-16	160 mm / 6 1/4"	MILLES
	Schneiden gezahnt	←
	toothed blades	
	ramas dentadas	
	tagli dentellati	
93211-18	185 mm / 7 1/4"	JACOBSON



93216-12	120 mm / 4 3/4"	VANNAS
93216-16	160 mm / 6 1/4"	



93217-12	120 mm / 4 3/4"	VANNAS
93217-16	160 mm / 6 1/4"	



93218-13	130 mm / 5 1/8"	BIEMER
	Venenschere	
	Vein Scissors	
	Tijera para venas	
	Forbice per vene	



93219-12	120 mm / 4 3/4"	VANNAS
----------	-----------------	--------



93221-18	185 mm / 7 1/4"	POTTS-YASARGIL
----------	-----------------	----------------



Mikro-Federscheren
 Micro Scissors (Spring Type)
 Micro tijeras
 Micro forbici



1/1



1/1

93270-14 145 mm / 5 3/4"
 93270-18 180 mm / 7"



1/1

93270-23 230 mm / 9"



1/1

93271-14 145 mm / 5 3/4"
 93271-18 180 mm / 7"



1/1

93273-14 145 mm / 5 3/4"
 93273-18 180 mm / 7"

Mikro Präparierscheren
 Micro dissecting Scissors
 Micro tijeras de disección
 Micro forbici per dissezione

Tumorschere
Tumor scissors
Tijera para tumores
Forbice per tumori

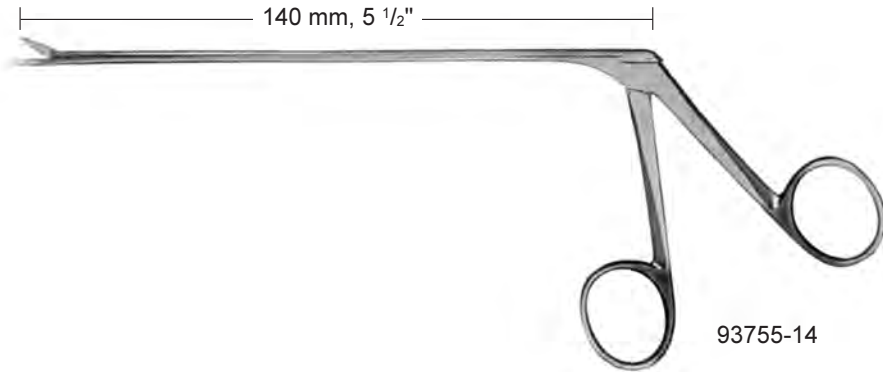

93755-14 gerade
straight
recta
retta

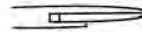

93756-14 rechts gebogen
curved right
curva hacia la derecha
curva a destra



93757-14 links gebogen
curved left
curva hacia la izquierda
curva a sinistra



Rippenscheren
Rib Shears
Costótomos
Costotomi



SAUERBRUCH
57131-26
26 cm, 10 1/4"



GIERTZ-STILLE
57137-27
27 cm, 10 1/2"



SAUERBRUCH-FREY
57141-36
36 cm, 14.2"

Reda Instrumente GmbH
Gänsäcker 34 - P.O. Box 131
D-78532 Tuttlingen



PINZETTEN

FORCEPS

PINZAS

PINZETTE



www.Reda-Instrumente.de

Anatomische und chirurgische Pinzetten
Dressing and Tissue Forceps
Pinzas de disección, sin/con dientes
Pinze per dissezione, chirurgiche/anatomiche



POTTS-SMITH

11112-18	18 cm, 7"	11116-18 TC
11112-21	21 cm, 8 1/4"	11116-21 TC
11112-25	25 cm, 10"	11116-25 TC



1x2

POTTS-SMITH

11126-18	18 cm, 7"	
11126-21	21 cm, 8 1/4"	
11126-25	25 cm, 10"	

Anatomische und chirurgische Pinzetten
 Dressing and Tissue Forceps
 Pinzas de disección, sin/con dientes
 Pinze per dissezione, chirurgiche/anatomiche



ADSON
 11170-12 12,0 cm, 4 ³/₄"
 11170-15 15,0 cm, 6"



ADSON
 11174-12 TC 12,0 cm, 4 ³/₄"
 11174-15 TC 15,0 cm, 6"



ADSON micro
 11176-12 12,0 cm, 4 ³/₄"
 11176-15 15,0 cm, 6"



ADSON-DE BAKEY atrauma
 11177-12
 12,0 cm, 4 ³/₄"



ADSON
 11178-12
 12,0 cm, 4 ³/₄"



ADSON
 11179-12
 12 cm, 4 ³/₄"

Anatomische und chirurgische Pinzetten
 Dressing and Tissue Forceps
 Pinzas de disección, sin/con dientes
 Pinze per dissezione, chirurgiche/anatomiche



ADSON
 11180-12 12,0 cm, 4 3/4"
 11180-15 15,0 cm, 6"

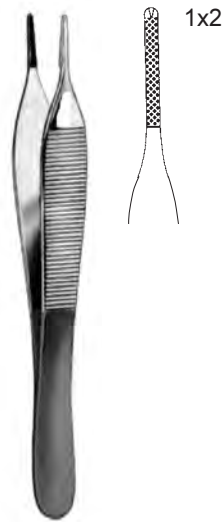

ADSON
 11181-12 TC 12,0 cm, 4 3/4"
 11181-15 TC 15,0 cm, 6"



ADSON micro
 11186-12 12,0 cm, 4 3/4"
 11186-15 15,0 cm, 6"



ADSON
 11187-12
 12 cm, 4 3/4"



ADSON-BROWN
 11188-12 12,0 cm, 4 3/4"
 11188-15 15,0 cm, 6"
 11189-12 TC 12,0 cm, 4 3/4"

Anatomische und chirurgische Pinzetten
 Dressing and Tissue Forceps
 Pinzas de disección, sin/con dientes
 Pinze per dissezione, chirurgiche/anatomiche



9x9

BROWN

- 11189-15 15,0 cm, 6"
- 11189-20 20,0 cm, 8"
- 11189-25 25,0 cm, 10"



1x2

WAUGH

- 11187-18 18 cm, 7"
- 11187-20 20 cm, 8"
- 11187-25 25 cm, 10"
- 11187-30 30 cm, 11 3/4"



11220-17

11224-17 TC



CUSHING
 17 cm, 6 3/4"



11221-17

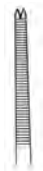

1x2

11222-17

11225-17 TC



CUSHING
 17 cm, 6 3/4"



1x2

11223-17

Anatomische und chirurgische Pinzetten
Dressing and Tissue Forceps
Pinzas de disección, sin/con dientes
Pinze per dissezione, chirurgiche/anatomiche



BROPHY
11231-20
20,0 cm, 8"



BROPHY
11233-20
20,0 cm, 8"



11234-20



11235-20



BROPHY
11236-15
20,0 cm, 8"



ADLERKREUTZ
11236-15 15,0 cm, 6"
11236-20 20,0 cm, 8"

Anatomische und chirurgische Pinzetten
Dressing and Tissue Forceps
Pinzas de disección, sin/con dientes
Pinze per dissezione, chirurgiche/anatomiche



DUEHRSEN
11237-20
20 cm, 8"



McINDOE
11257-15
15,0 cm, 6"



McINDOE
11258-15 15,0 cm, 6"
11259-15 TC 15,0 cm, 6"

Anatomische und chirurgische Pinzetten
 Dressing and Tissue Forceps
 Pinzas de disección, sin/con dientes
 Pinze per dissezione, chirurgiche/anatomiche



SEMKEN
 11260-12 12,5 cm, 5"
 11260-15 15,5 cm, 6"
 11261-15 TC 15,5 cm, 6"



1x2

SEMKEN
 11270-12 12,5 cm, 5"
 11270-15 15,5 cm, 6"
 11271-15 TC 15,5 cm, 6"
 11271-18 TC 18,0 cm, 7"



1x2

GILLIES
 11272-15 15,5 cm, 6"
 11273-15 TC 15,5 cm, 6"



15,5 cm, 6"



11274-06
 0,6 mm



11274-08
 0,8 mm



11274-10
 1,0 mm



GERALD
 11302-17 17,5 cm, 6.9"
 11302-23 23,0 cm, 9"
 11304-17 TC 17,0 cm, 6 3/4"



GERALD
 11303-17
 17,5 cm, 6.9"

Anatomische und chirurgische Pinzetten
Dressing and Tissue Forceps
Pinzas de disección, sin/con dientes
Pinze per dissezione, chirurgiche/anatomiche



GERALD
11305-17
17,5 cm, 6.9"



GERALD
11310-17 17,5 cm, 6.9"
11312-17 TC 17,5 cm, 6.9"

1x2



GERALD
11311-17
17,5 cm, 6.9"

1x2



CUSHING-TAYLOR
11312-18 TC 18,5 cm, 7 1/4"



GERALD
11313-17 17,5 cm, 6.9"

1x2

Anatomische und chirurgische Pinzetten
 Dressing and Tissue Forceps
 Pinzas de disección, sin/con dientes
 Pinze per dissezione, chirurgiche/anatomiche

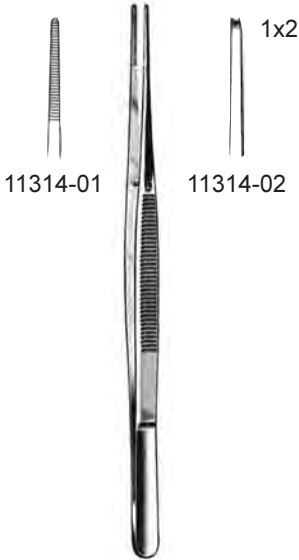

TAYLOR
 17 cm, 6 3/4"

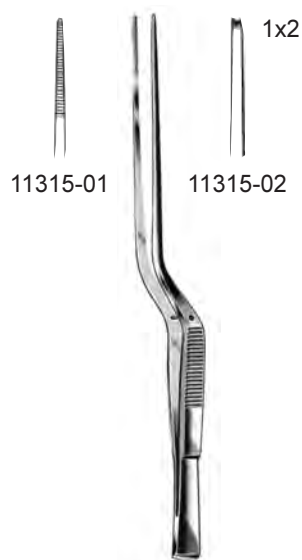

TAYLOR
 17 cm, 6 3/4"



WANGENSTEEN
 11324-23 23 cm 9"



WANGENSTEEN
 11325-15 TC 15 cm, 6"
 11325-23 TC 23 cm, 9"
 11325-25 TC 25 cm, 10"



MAYO
 11326-23 23 cm, 9"

Hirnspatelpinzette
Brain Spatula Forceps
Pinza-espátula cerebral
Pinze a spatola cerebrale



SCOVILLE
22 cm, 8 ³/₄"



10 mm
11327-10



13 mm
11327-13

Uhrmacherpinzette
Jeweler Type Forceps
Pinzas de relojero
Pinze da orologiaio

Fig. 1



11401-01
12 cm, 4 3/4"

Fig. 3



11403-03
12 cm, 4 3/4"

Fig. 3c



11403-04
11 cm, 4 3/8"

Fig. 4



11404-04
11 cm, 4 3/8"

Fig. 5



11405-05
11 cm, 4 3/8"





Fig. 7



11407-07
12 cm, 4 3/4"

Gefäßdilatoren
Vessel dilators
Dilatadores vasculares
Pinze dilatatori vascolari



	0,2 mm	0,3 mm	0,2 mm	0,3 mm
				
	11408-01 11 cm, 4 ³ / ₈ "	11408-02 11 cm, 4 ³ / ₈ "	11408-03 13,5 cm, 5 ¹ / ₄ "	11408-04 13,5 cm, 5 ¹ / ₄ "

Juwelierpinzette/Uhrmacherpinzette
Jeweler's Forceps/Jeweler Type Forceps
Pinzas para joyero/Pinzas de relojero
Pinze per gioielliere/Pinze da orologiaio



11,5 cm, 4 ¹/₂"



11 cm, 4 ³/₈"

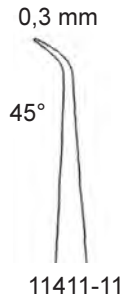

Mikro Knüpfpinzetten
 Micro Suture Tying Forceps
 Micro Pinzas para ligaduras
 Micro Pinze per legature



	0,3 mm	0,8 mm
12 cm, 4 3/4"	12102-12	
	12102-12D	
15 cm, 6"	12104-15	
	12104-15D	
18 cm, 7"		12108-18
		12108-18D
21 cm, 8 1/4"		12102-21
		12102-21D
23 cm, 9"		12102-23
		12102-23D



	0,3 mm	0,8 mm
12 cm, 4 3/4"	12103-12	
	12103-12D	
15 cm, 6"	12103-15	
	12103-15D	
18 cm, 7"		12109-18
		12109-18D
21 cm, 8 1/4"		12109-21
		12109-21D
23 cm, 9"		12109-23
		12109-23D

1x2



	0,3 mm	0,3 mm
15 cm, 6"	12090-15D	12091-15D
18 cm, 7"	0,4 mm	0,4 mm
	12090-18D	12091-18D
21 cm, 8 1/4"	0,8 mm	0,8 mm
	12090-21D	12091-21D
23 cm, 9"	12090-23D	12091-23D

1x2



D = mit diamantiertem Maul
 with diamond jaw
 con boca de diamante
 con morso diamantato

Mikro Knüpfpinzetten
Micro Suture Tying Forceps
Micro Pinzas para ligaduras
Micro Pinze per legature



LAZAR



93340-15 155 mm / 6"
Spitzen 0,5 mm
tips 0,5 mm
puntas de 0,5 mm
punte 0,5 mm



93342-15 155 mm / 6"
Spitzen 0,8 mm
tips 0,8 mm
puntas de 0,8 mm
punte 0,8 mm



93342-18 185 mm / 7 1/4"
Spitzen 0,5 mm
tips 0,5 mm
puntas de 0,5 mm
punte 0,5 mm

Mikro Knüpfpinzetten
 Micro Suture Tying Forceps
 Micro Pinzas para ligaduras
 Micro Pinze per legature



0,3 mm 93350-12
 120 mm / 4 3/4"



0,3 mm 93350-13
 135 mm / 5 1/4"



0,3 mm 93351-13
 135 mm / 5 1/4"



WISE



1x2

0,2 mm 93360-09
 95 mm / 3 3/4"



0,8 mm 93370-14
 140 mm / 5 1/2"



93370-18
 180 mm / 7" AUSTIN

93360-09
 95 mm
 3 3/4"

Ultra-Light-Pinzetten
Ultra-Light-Forceps
Pinzas-Ultra-Ligeras
Pinza-Ultra-Leggera

1,5 mm

1,2 mm

1,5 mm

1,5 mm



12110-15
15 cm, 6"

12110-20
20 cm, 8"

12110-24
24 cm, 9 1/2"

12110-30
30 cm, 11 3/4"

Mikro Ring Pinzetten
 Micro Ring Forceps
 Micro Pinzas
 Micro Pinza



	Ø 1 mm x 0,5 mm	Ø 2 mm x 1 mm
15 cm, 6"	12112-15D 12112-15T	12114-15D 12114-15T
18 cm, 7"	12112-18D 12112-18T	12114-18D 12114-18T
21 cm, 8 1/4"	12112-21D 12112-21T	12114-21D 12114-21T
23 cm, 9"	12112-23D 12112-23T	12114-23D 12114-23T

D = mit diamantiertem Maul
 with diamond jaw
 con boca de diamante
 con morso diamantato
 T = Titan, titanium, titanio, titanio

Atrauma Mikro Pinzetten
Atrauma Micro Forceps
Micro Pinzas Atraumáticas
Micro Pinza Atraumatica



	1,2 mm	2,0 mm
15 cm, 6"	12115-15 12115-15T	12116-15
18 cm, 7"	12115-18 12115-18T	12116-18
21 cm, 8 1/4"	12115-21 12115-21T	12116-21
23 cm, 9"	12115-23 12115-23T	12116-23

T = Titan, titanium, titanio, titanio

DE BAKEY

TC Atrauma Pinzetten
TC Atrauma Forceps
Pinzas Atraumáticas con TC
Pinza Atraumatica TC



	1,2 mm	2,0 mm
18 cm, 7"	12117-18 TC	12118-18 TC
21 cm, 8 1/4"	12117-21 TC	12118-21 TC
23 cm, 9"	12117-23 TC	12118-23 TC

DE BAKEY TC

Atraumatische Pinzetten
 Atraumatic Tissue Forceps
 Pinzas Atraumáticas
 Pinze Atraumatiche



DE BAKEY
 12302-16 16 cm, 6 1/4"
 12302-20 20 cm, 8"
 12302-24 24 cm, 9 1/2"



DE BAKEY
 12306-16 16 cm, 6 1/4"
 12306-20 20 cm, 8"
 12306-24 24 cm, 9 1/2"
 12306-30 30 cm, 11 3/4"



DE BAKEY
 12308-16 16 cm, 6 1/4"
 12308-20 20 cm, 8"
 12308-24 24 cm, 9 1/2"
 12308-30 30 cm, 11 3/4"



DE BAKEY
 12309-16 16 cm, 6 1/4"
 12309-20 20 cm, 8"
 12309-24 24 cm, 9 1/2"
 12309-30 30 cm, 11 3/4"



DE BAKEY
 12304-16 16 cm, 6 1/4"
 12304-20 20 cm, 8"
 12304-24 24 cm, 9 1/2"
 12304-30 30 cm, 11 3/4"



DE BAKEY
 12310-16 16 cm, 6 1/4"
 12310-20 20 cm, 8"
 12310-24 24 cm, 9 1/2"
 12310-30 30 cm, 11 3/4"

Pinzetten zum Fassen von Gewebe, Tumoren
 Forceps for grasping tissue, tumors
 Pinzas para coger tejidos y tumores
 Pinze per afferrare tessuti e tumori



12295-22 200 mm / 8" YASARGIL
 Maul flach, gezahnt
 flat jaw, serrated
 boca plana, dentada
 morso piatto, striato



12297-22 200 mm / 8" HUNT
 Maul flach, gezahnt
 flat jaw, serrated
 boca plana, dentada
 morso piatto, striato



12300-18 185 mm / 7 1/4"
 feine Spitzen
 fine tips
 puntas finas
 punte acute



12302-18 185 mm / 7 1/4"
 breite Spitzen
 broad tips
 puntas anchas
 punte smusse



12303-18 185 mm / 7 1/4"
 breite Spitzen
 broad tips
 puntas anchas
 punte smusse

Pinzetten zum Fassen von Gewebe, Tumoren
Forceps for grasping tissue, tumors
Pinzas para coger tejidos y tumores
Pinze per afferrare tessuti e tumori



Ø 5 mm

Maul flach, gezahnt
flat jaw, serrated
boca plana, dentada
morso piatto, striato

HUNT
12305-20
200 mm
8"

Pinzetten zum Fassen von Gewebe, Tumoren
 Forceps for grasping tissue, tumors
 Pinzas para coger tejidos y tumores
 Pinze per afferrare tessuti e tumori



	 Ø 3 mm	93300-22 93300-24	220 mm / 8 3/4" 240 mm / 9 1/2"	YASARGIL YASARGIL-SAMII
	Maul löffelförmig jaw spoon-shaped boca en forma de cucharilla morso forma cucchiaio liscio			
	 Ø 5 mm	93302-22 93302-24	220 mm / 8 3/4" 240 mm / 9 1/2"	YASARGIL YASARGIL-SAMII
	Maul löffelförmig jaw spoon-shaped boca en forma de cucharilla morso forma cucchiaio liscio			
	 Ø 7 mm	93304-24	240 mm / 9 1/2"	YASARGIL-SAMII
	Maul löffelförmig jaw spoon-shaped boca en forma de cucharilla morso forma cucchiaio liscio			
	 Ø 3 mm	93306-22	220 mm / 8 3/4"	YASARGIL
Maul flach, gezahnt flat jaw, serrated boca plana, dentada morso piatto, striato				
 Ø 5 mm	93308-22	220 mm / 8 3/4"	YASARGIL	
Maul flach, gezahnt flat jaw, serrated boca plana, dentada morso piatto, striato				
 Ø 3 mm	93310-22	220 mm / 8 3/4"	HEIFETZ	
Maul kürettenförmig curette jaw, toothed boca en forma de cureta, estriada morso forma curetta, striato				
 Ø 5 mm	93312-22	220 mm / 8 3/4"	HEIFETZ	
Maul kürettenförmig curette jaw, toothed boca en forma de cureta, estriada morso forma curetta, striato				

Pinzetten zum Fassen von Gewebe, Tumoren
Forceps for grasping tissue, tumors
Pinzas para coger tejidos y tumores
Pinze per afferrare tessuti e tumori

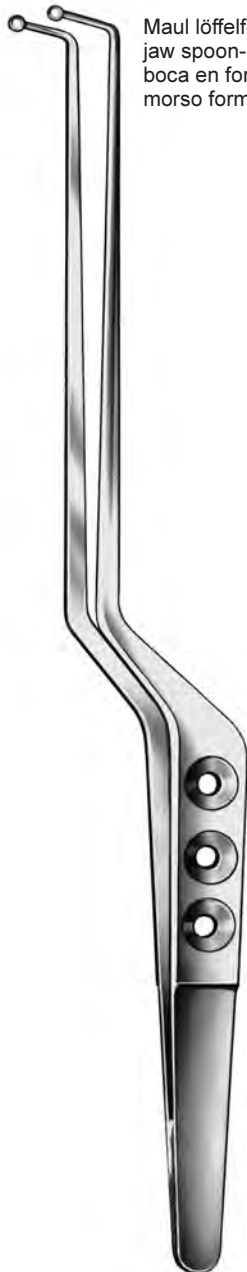

Maul löffelförmig
jaw spoon-shaped
boca en forma de cucharilla
morso forma cucchiaino liscio

SAMII
230 mm
9"



93321-23

Ø 3 mm



93323-23

Ø 4 mm

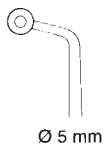

93325-23

Ø 5 mm



93327-23

Ø 3 mm



93329-23

Ø 4 mm



93331-23

Ø 5 mm

Pinzette, bajonettförmig
Forceps, bayonet-shaped
Pinzas, forma bayoneta
Pinze, forma di baionetta



LUCAE
45206-14 14 cm, 5 1/2"



LUCAE
45206-16 16 cm, 6 1/4"



COTTLE
45208-14 14 cm, 5 1/2"



JANSEN-GRUENWALD
47154-20 20 cm, 8"



JANSEN
47155-20 20 cm, 8"

Mikro Pinzetten, bajonettförmig
 Micro Forceps, bayonet-shaped
 Micro Pinzas, forma bayoneta
 Micro Pinze, forma di baionetta



YASARGIL



93290-16 160 mm / 6¹/₄"
 93290-18 180 mm / 7"
 93290-20 200 mm / 8"
 93290-22 220 mm / 8³/₄"
 93290-24 240 mm / 9¹/₂"

Spitzen 0,6 mm
 tips 0,6 mm
 puntas de 0,6 mm
 punte 0,6 mm



93292-16 160 mm / 6¹/₄"
 93292-18 180 mm / 7"
 93292-20 200 mm / 8"
 93292-22 220 mm / 8³/₄"
 93292-24 240 mm / 9¹/₂"

Spitzen 0,9 mm
 tips 0,9 mm
 puntas de 0,9 mm
 punte 0,9 mm



93294-18 180 mm / 7"
 1 x 2 Zähne
 1 x 2 teeth
 1 x 2 dientes
 1 x 2 denti

Reda Instrumente GmbH
Gänsäcker 34 - P.O. Box 131
D-78532 Tuttlingen



KLEMMEN

CLAMPS

PINZAS

PINZE



www.Reda-Instrumente.de

Mini-Bulldogklemmen
 Mini Bulldog Clamps
 Clamps Bulldog Mini
 Pinze Bulldog Mini

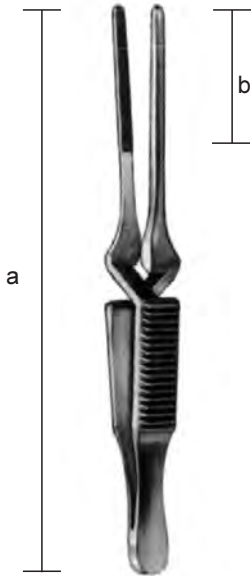

DIETHRICH

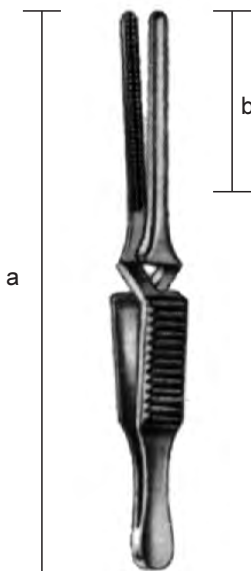
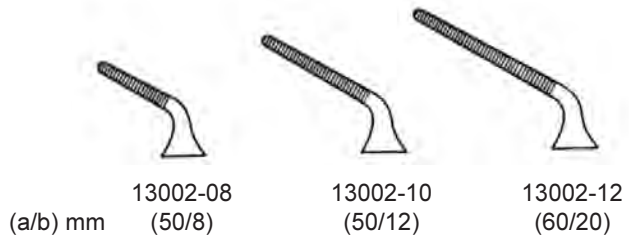
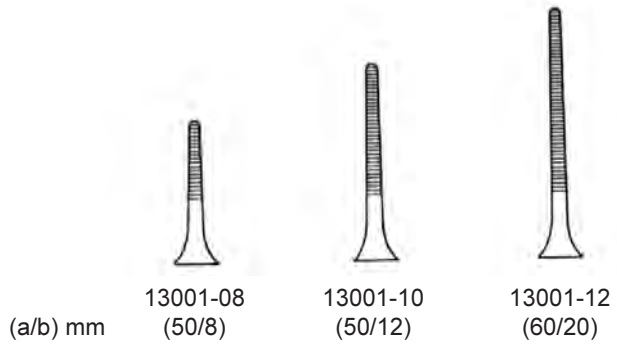

DE BAKEY-DIETHRICH

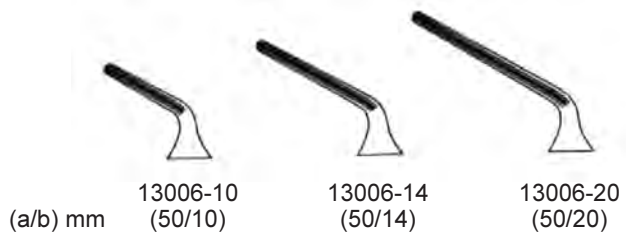
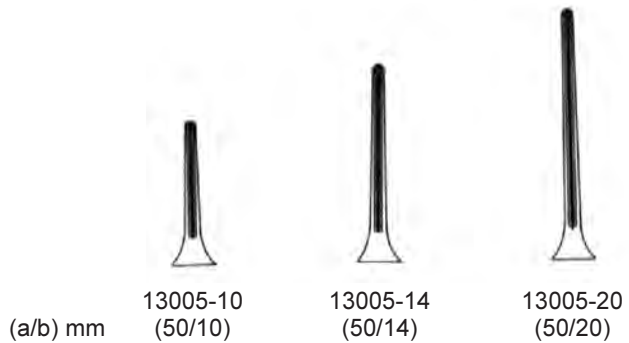

Titan-Atrauma-Bulldogklemmen
 Titanium Atrauma Bulldog Clamps
 Titan Clamp Bulldog
 Titan Pinze Bulldog



	3 cm, 1.2"	3,5 cm, 1.4"	4 cm, 1 1/2"	5 cm, 2"
Vene	13010-30	13010-35	13010-40	13010-50
Arterie	13011-30	13011-35	13011-40	13011-50



	3 cm, 1.2"	3,5 cm, 1.4"	4 cm, 1 1/2"	5 cm, 2"
Vena	13012-30	13012-35	13012-40	13012-50
Arteria	13013-30	13013-35	13013-40	13013-50



	3 cm, 1.2"	3,5 cm, 1.4"	4 cm, 1 1/2"	5 cm, 2"
Vene	13014-30	13014-35	13014-40	13014-50
Arterie	13015-30	13015-35	13015-40	13015-50

Atrauma-Bulldogklemmen
Atrauma-Bulldog Clamps
Clamps Atrauma Bulldog
Pinze Atrauma Bulldog



13090-40
40 mm / 1 1/2"

13090-45
45 mm / 1 3/4"

13090-50
50 mm / 2"



13091-40
40 mm / 1 1/2"

13091-45
45 mm / 1 3/4"

13091-50
50 mm / 2"

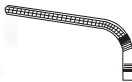

GLOVER
13098-06
57 mm
2 3/8"



DE BAKEY
13099-07
73 mm
2 3/4"

Atrauma-Bulldogklemmen
 Atrauma Bulldog Clamps
 Clamps Atrauma Bulldog
 Pinze Atrauma Bulldog



DE BAKEY

13092-07
7,5 cm
3"

13092-08
8,5 cm
3.4"

13092-10
10,5 cm
4"

13092-12
12 cm
4 3/4"

13093-07
7 cm
2 3/4"

13093-08
8 cm
8 1/8"

13093-10
10 cm
4"

13093-12
11,5 cm
4 1/2"



GLOVER

13096-06
6 cm
2 1/4"

13096-07
7 cm
2 3/4"

13096-09
9 cm
3 1/2"

13096-11
11 cm
4 3/8"

13097-06
5,5 cm
2"

13097-07
6,5 cm
2 1/2"

13097-09
8,5 cm
3 1/4"

13097-11
10,5 cm
4"

Atrauma-Bulldogklemmen
Atrauma-Bulldog Clamps
Clamps Atrauma Bulldog
Pinze Atrauma Bulldog



DE BAKEY
13094-09
9 cm, 3 1/2"



DE BAKEY
13095-10
10 cm, 4"



3 cm, 1.2"

Maulänge
Jaw length
Largo de la boca
Lunghezza del morso

DE BAKEY-HESS
13113-03

Gefäßklemmen, Bulldogklemmen, Arterienklemmen
 Bulldog Clamps, Hemostatic Forceps
 Pinzas serra-finas, Pinzas hemostáticas
 Pinze serrafina, Pinze emostatiche



DIEFFENBACH

- 13102-04 3,5 cm, 1.4"
- 13102-05 5,5 cm, 2.2"



DIEFFENBACH

- 13103-04 3,5 cm, 1.4"
- 13103-05 5,5 cm, 2.2"

gerade
 straight
 recta
 rette



gebogen
 curved
 curva
 curve

JOHNS-HOPKINS

- | | | |
|----------|----------------|----------|
| 13110-50 | 5,0 cm, 2" | 13111-50 |
| 13110-55 | 5,5 cm, 2.2" | 13111-55 |
| 13110-65 | 6,5 cm, 2.6" | 13111-65 |
| 13110-70 | 7,0 cm, 2 3/4" | 13111-70 |
| 13110-75 | 7,5 cm, 3" | 13111-75 |
| 13110-90 | 9,0 cm, 3 1/2" | 13111-90 |

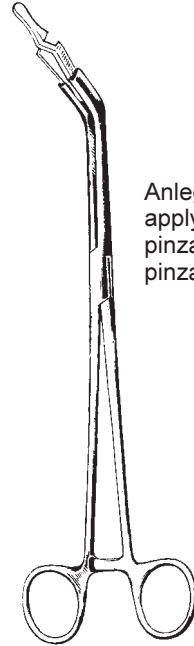

Anlegezange
 applying Forceps
 pinza aplicadora
 pinza applicatrice

- 13115-00
- 23 cm, 9"

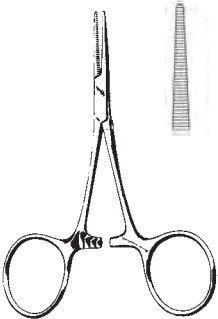

- HARTMANN**
- 13210-10
- 10 cm, 4"

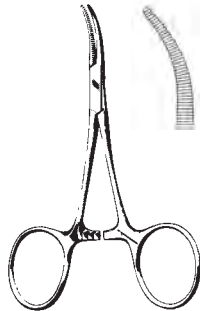

- HARTMANN**
- 13211-10
- 10 cm, 4"

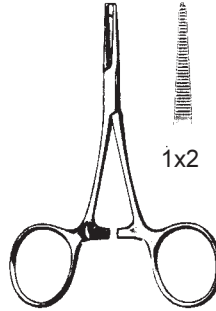

- HARTMANN**
- 13212-10
- 10 cm, 4"

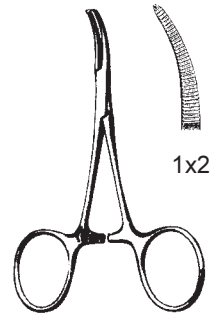

- HARTMANN**
- 13213-10
- 10 cm, 4"

- Micro-HARTMANN**
- 13214-10
- 10 cm, 4"

- Micro-HARTMANN**
- 13215-10
- 10 cm, 4"

Arterienklemmen
 Hemostatic Forceps
 Pinzas hemostáticas
 Pinze emostatiche

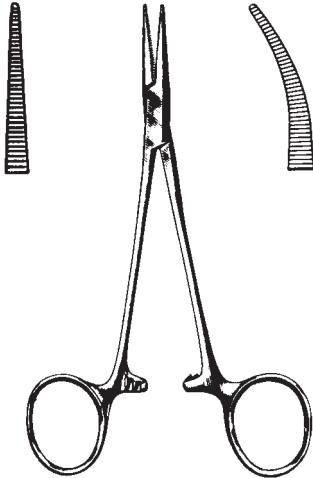

HALSTED-MOSQUITO

TITAN		TITAN
13224-12		13225-12
13220-12	12,5 cm, 5"	13221-12
13220-14	14,0 cm, 5 1/2"	13221-14
13220-18	18,0 cm, 7"	13221-18

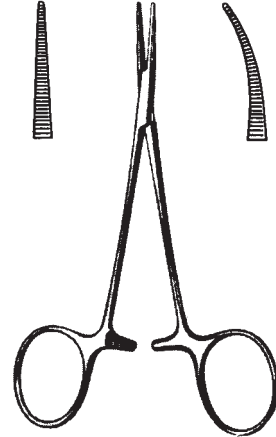

HALSTED-MOSQUITO micro

13222-12	12,5 cm, 5"	13223-12
----------	-------------	----------

JACOBSON micro

13226-12	12,0 cm, 4 3/4"	13227-12
----------	-----------------	----------

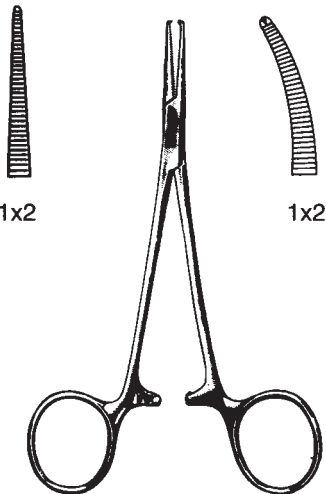

HALSTED-MOSQUITO

13230-12	12,5 cm, 5"	13231-12
13230-14	14,0 cm, 5 1/2"	13231-14

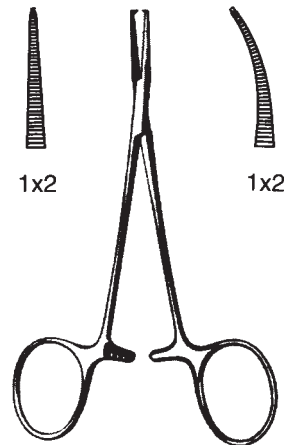

HALSTED-MOSQUITO micro

13232-12	12,5 cm, 5"	13233-12
----------	-------------	----------

Arterienklemmen
 Hemostatic Forceps
 Pinzas hemostáticas
 Pinze emostatiche

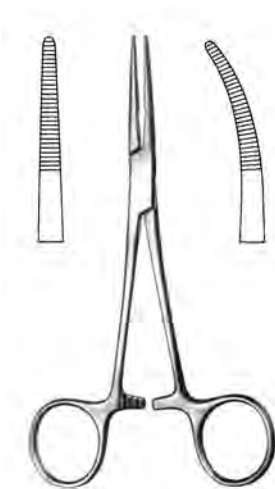

KELLY

- | | | |
|----------|---------------|----------|
| 13240-14 | 14 cm, 5 1/2" | 13241-14 |
| 13240-18 | 18 cm, 7" | 13241-18 |
| 13244-14 | 14 cm, 5 1/2" | 13245-14 |
| TITAN | | TITAN |

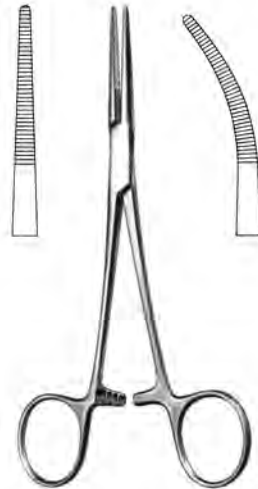

KELLY-RANKIN

- | | | |
|----------|---------------|----------|
| 13242-16 | 16 cm, 6 1/4" | 13243-16 |
|----------|---------------|----------|



CRILE

- | | | |
|----------|---------------|----------|
| 13250-14 | 14 cm, 5 1/2" | 13251-14 |
| 13250-18 | 18 cm, 7" | 13251-18 |
| 13254-14 | 14 cm, 5 1/2" | 13255-14 |
| TITAN | | TITAN |

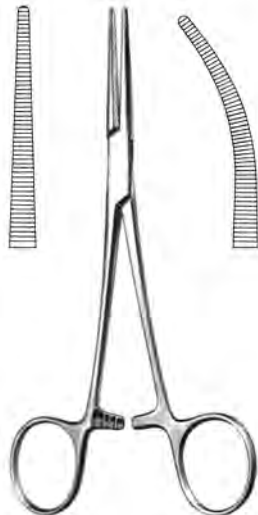

CRILE-RANKIN

- | | | |
|----------|---------------|----------|
| 13262-16 | 16 cm, 6 1/4" | 13263-16 |
|----------|---------------|----------|

Arterienklemmen
Hemostatic Forceps
Pinzas hemostáticas
Pinze emostatiche

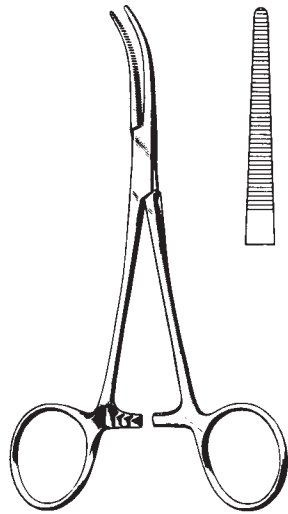

DANDY

13345-12 12 cm, 4 ³/₄"
13345-14 14 cm, 5 ¹/₂"

Kopfschwartenzangen
Scalp Flap Forceps
Pinzas para el cuero cabelludo
Pinze per cuoio capelluto

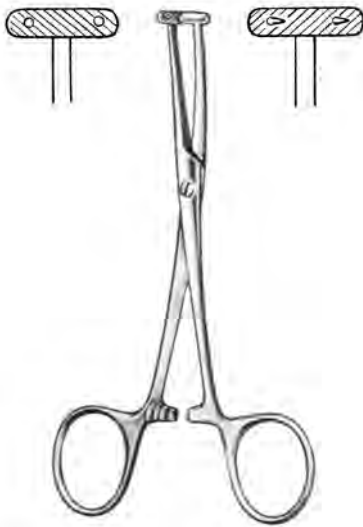

MARTEL
13364-14 14 cm, 5 1/2"



WILLET MARTEL
13366-19 19 cm, 7 1/2"

Präparier- und Ligaturklemmen
Dissecting and Ligature Forceps
Pinzas para preparaciones y para ligaduras
Pinze per preparazione e per legatura



FUCHSIG
13414-20 19 cm, 7 1/2"



ADSON BABY
13415-14 14,0 cm, 5 1/2"
13415-18 18,5 cm, 7 1/4"

Präparier- und Ligaturklemmen
Dissecting and Ligature Forceps
Pinzas para preparaciones y para ligaduras
Pinze per preparazione e per legatura



GEMINI

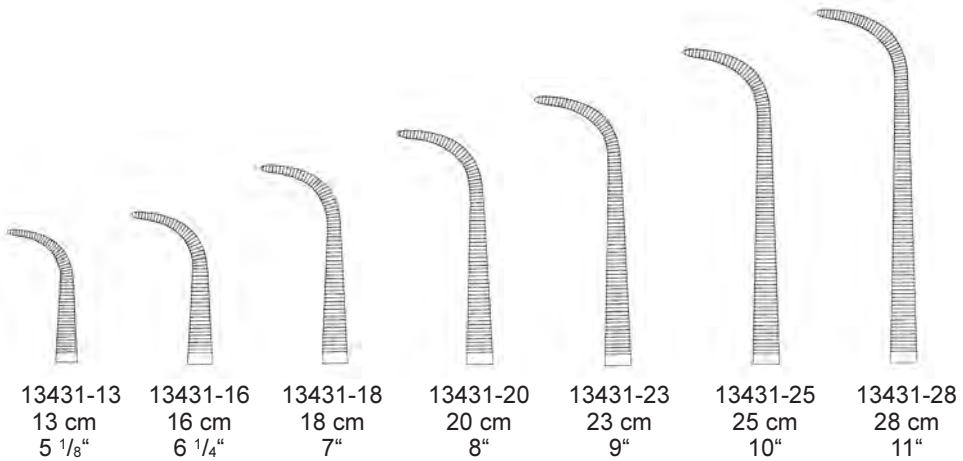

Präparier- und Ligaturklemmen
Dissecting and Ligature Forceps
Pinzas para preparaciones y para ligaduras
Pinze per preparazione e per legatura



MIXTER BABY
13475-14
14 cm, 5 1/2"



MIXTER BABY
13475-18
18 cm, 7"

Tumorfaßzange
Tumor Grasping Forcep
Pinza para agarrar tumores
Pinze per afferrare tumori



TOENNIS
20 cm, 8"



13610-01



13610-02



13610-03

Sehnenfaßzange
Tendon grasping Forceps
Pinza para agarrar tendones
Pinze da presa per tendini



CAROLL
33966-11
11 cm, 4 $\frac{3}{8}$ "

Reda Instrumente GmbH
Gänsäcker 34 - P.O. Box 131
D-78532 Tuttlingen



NADELHALTER

NEEDLE HOLDERS

PORTA-AGUJAS

PORT'AGHI



www.Reda-Instrumente.de

Nadelhalter
 Needle Holders
 Porta-agujas
 Port'aghi

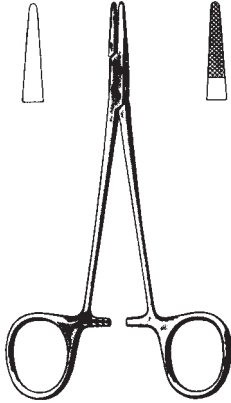

HALSEY

25130-13 25140-13
25134-13 TC **25144-13 TC**
 13 cm, 5 1/8"

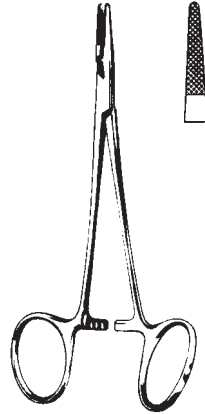

NEIVERT

25148-13 TC
 13 cm, 5 1/8"

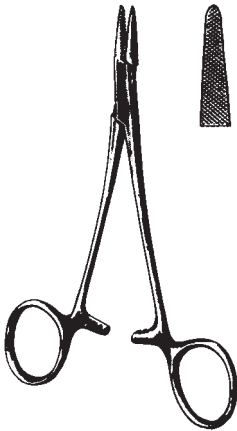

BAUMGARTNER

25150-14 **25154-14 TC**
 14,0 cm , 5 1/2"



CRILE-WOOD

25160-15 15 cm, 6" **25164-15 TC**
 25160-18 18 cm, 7" **25164-18 TC**
 25160-20 20 cm, 8" **25164-20 TC**
 25160-23 23 cm, 9" **25164-23 TC**

Nadelhalter
Needle Holders
Porta-agujas
Port'aghi

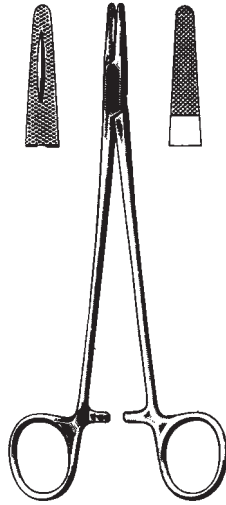

MAYO-HEGAR

25180-14	14 cm, 5 1/2"	25184-14 TC
25180-16	16 cm, 6 1/4"	25184-16 TC
25180-18	18 cm, 7"	25184-18 TC
25180-20	20 cm, 8"	25184-20 TC
25180-24	24 cm, 9 1/2"	25184-24 TC
25180-26	26 cm, 10 1/4"	25184-26 TC



DE BAKAY

25214-16 TC	16 cm, 6 1/4"
25214-18 TC	18 cm, 7"
25214-20 TC	20 cm, 8"
25214-23 TC	23 cm, 9"
25214-26 TC	26 cm, 10 1/4"



RYDER 1 mm

25224-13 TC	13 cm, 5 1/8"
25224-15 TC	15 cm, 6"
25224-18 TC	18 cm, 7"
25224-20 TC	20 cm, 8"
25224-23 TC	23 cm, 9"
25224-26 TC	26 cm, 10 1/4"

RYDER 2 mm

25225-13 TC
25225-15 TC
25225-18 TC
25225-20 TC
25225-23 TC
25225-26 TC

Mikro-Nadelhalter
 Micro Needle Holders
 Micro-porta-agujas
 Micro portaghi



BARRAQUER

ohne Sperre
 without lock
 sin cremallera
 senza cremagliera

mit Sperre
 with lock
 con cremallera
 con cremagliera



11,5 cm, 4 1/2"
 13,0 cm, 5 1/8"
 14,0 cm, 5 1/2"
 18,0 cm, 7"
 21,0 cm, 8 1/4"
 23,0 cm, 9"

25660-12
 25660-13
 25660-14
 25700-18

25661-12
 25661-13
 25661-14
 25701-18

25720-12
 25720-13
 25720-14
 25730-18
 25730-21
 25730-23

25731-12
 25731-13
 25731-14
 25731-18
 25731-21
 25731-23

mit diamantiertem Maul
 with diamond jaw
 con boca de diamante
 con morso diamantato

11,5 cm, 4 1/2"
 13,0 cm, 5 1/8"
 14,0 cm, 5 1/2"
 18,0 cm, 7"
 21,0 cm, 8 1/4"
 23,0 cm, 9"

25720-12D
 25720-13D
 25720-14D
 25730-18D
 25730-21D
 25730-23D

25671-12D
 25671-13D
 25671-14D
 25731-18D
 25731-21D
 25731-23D

T = Titan, titanium, titanio, titanio



15,0 cm, 6"
 18,0 cm, 7"
 21,0 cm, 8 1/4"

93250-15T	93251-15T	93260-15T	93261-15T
93250-18T	93251-18T	93260-18T	93261-18T
93250-21T	93251-21T	93260-21T	93261-21T

Mikro-Nadelhalter mit Sperre
 Micro Needle Holders, with lock
 Micro-porta-agujas con cremallera
 Micro portaghi, con cremagliera

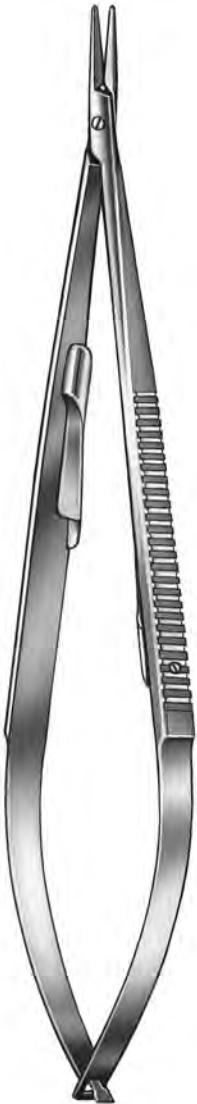

CASTROVIEJO



14,0 cm, 5 1/2"
 18,0 cm, 7"
 21,5 cm, 8 1/2"
 23,0 cm, 9"

25670-14
 25670-18
 25670-21

25671-14
 25671-18

25672-14
 25672-18
 25672-21
 25672-23

25673-14
 25673-18

mit TC 1,4 mm
 with TC jaw 1,4 mm
 con TC 1,4 mm
 con morso in TC 1,4 mm

14,0 cm, 5 1/2"
 18,0 cm, 7"
 21,5 cm, 8 1/2"
 23,0 cm, 9"

25674-14	25675-14	25676-14	25677-14
25674-18	25675-18	25668-18	25691-18
25674-21		25668-21	
		25668-23	

mit diamantiertem Maul 0,8 mm
 with diamond jaw 0,8 mm
 con boca de diamante 0,8 mm
 con morso diamantato 0,8 mm

14,0 cm, 5 1/2"
 18,0 cm, 7"
 21,5 cm, 8 1/2"
 23,0 cm, 9"

25672-14D 25673-14D
 25672-18D 25673-18D
 25672-21D
 25672-23D

T = Titan, titanium, titanio, titanio
 Maul/jaw/boca/morso 0,4mm

14,0 cm, 5 1/2"
 18,0 cm, 7"
 21,5 cm, 8 1/2"

25672-14T	25673-14T
25672-18T	25673-18T
25672-21T	25673-21T

Mikro-Nadelhalter, bajonettförmig
Micro Needle Holders, bayonet-shaped
Micro-porta-agujas, forma bayoneta
Micro port'aghi, forma baionetta



93092-20	200 mm / 8"
93092-22	225 mm / 9"



93093-16	165 mm / 6 1/2"
93093-20	200 mm / 8"
93093-22	225 mm / 9"
93093-24	245 mm / 9 3/4"

YASARGIL

Mikro-Nadelhalter
Micro Needle Holders
Micro-porta-agujas
Micro port'aghi



93170-16 160 mm / 6 1/4"
93170-18 185 mm / 7 1/4"

ohne Sperre
without catch
sin cremallera
senza cremagliera



93171-16 160 mm / 6 1/4"
93171-18 185 mm / 7 1/4"

ohne Sperre
without catch
sin cremallera
senza cremagliera

Mikro-Nadelhalter
Micro Needle Holders
Micro-porta-agujas
Micro port'aghi

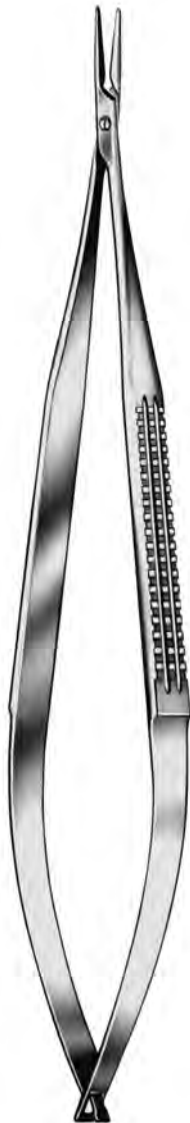

93200-16
93200-18

160 mm / 6 1/4"
185 mm / 7 1/4"

ohne Sperre
without catch
sin cremallera
senza cremagliera



93201-16
93201-18

160 mm / 6 1/4"
185 mm / 7 1/4"

ohne Sperre
without catch
sin cremallera
senza cremagliera

Reda Instrumente GmbH
Gänsäcker 34 - P.O. Box 131
D-78532 Tuttlingen



HAKEN

HOOKS

GANCHOS

UNCINI



www.Reda-Instrumente.de

Hauthäkchen
 Skin Hooks
 Ganchos para la piel
 Uncini per pelle

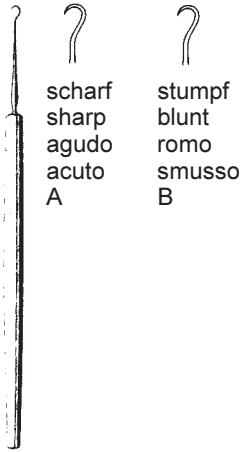

scharf
 sharp
 agudo
 acuto
 A

stumpf
 blunt
 romo
 smusso
 B

- FRAZIER**
- A 19214-13 13 cm, 5"
 - A 19214-18 18 cm, 7"
 - B 19215-13 13 cm, 5"
 - B 19215-18 18 cm, 7"

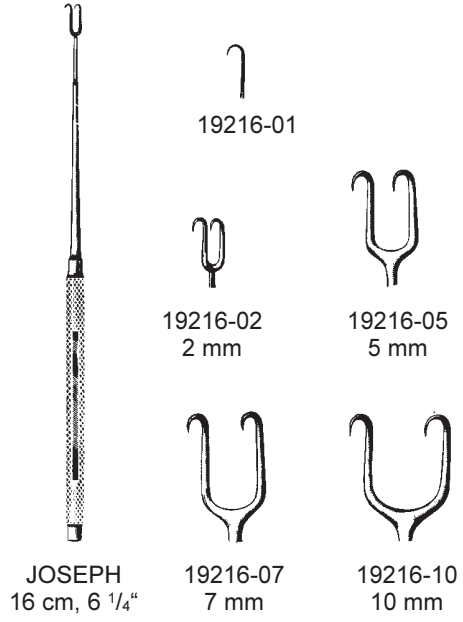

JOSEPH
 16 cm, 6 1/4"

19216-01

19216-02
 2 mm

19216-05
 5 mm

19216-07
 7 mm

19216-10
 10 mm



FREER
 47558-15
 15 cm, 6"



GILLIES
 18 cm, 7"

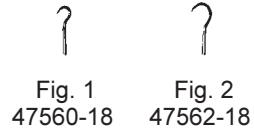

Fig. 1
 47560-18

Fig. 2
 47562-18

Wundhaken
Retractors
Separadores
Divaricatori



Blattretractor
blade retractor
separador de hoja
lama divaricatore

CLOWARD
19128-18 18 mm
19128-20 20 mm
19128-23 23 mm



CUSHING
19234-20
20 cm, 8"



CUSHING
19235-21
21,5 cm, 8 1/2"

Wundhaken
Retractors
Separadores
Divaricatori

- 19314-07 35x 7 mm
- 19314-10 35x10 mm
- 19314-12 80x12 mm
- 19314-14 70x14 mm
- 19314-15 35x15 mm
- 19314-16 80x16 mm
- 19314-20 60x20 mm
- 19315-06 25x 6 mm
- 19330-40 40x12 mm
- 19330-55 55x11 mm

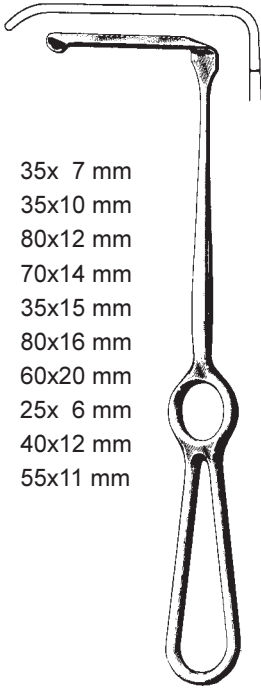

KOCHER-LANGENBECK
21 cm, 8 1/4"

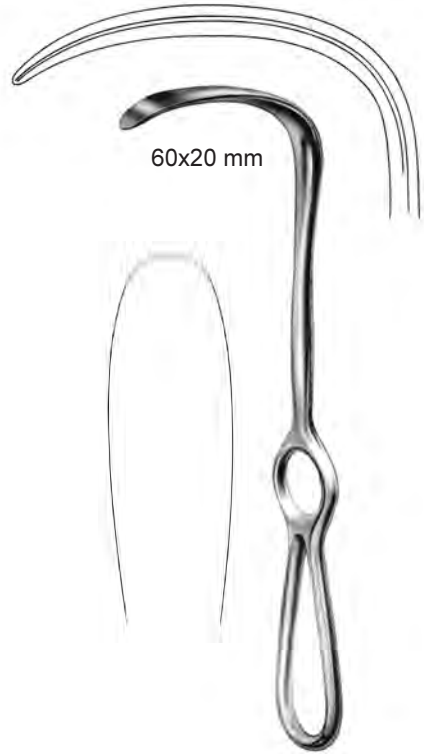

LANGENBECK
19315-21
21 cm, 8 1/4"

Wundhaken
Retractors
Separadores
Divaricatori

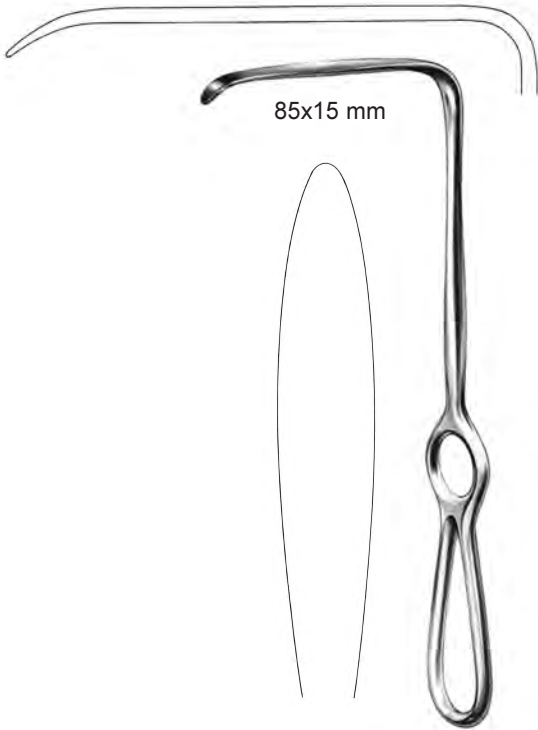

85x15 mm

LANGENBECK
19317-21
21 cm, 8 1/4"

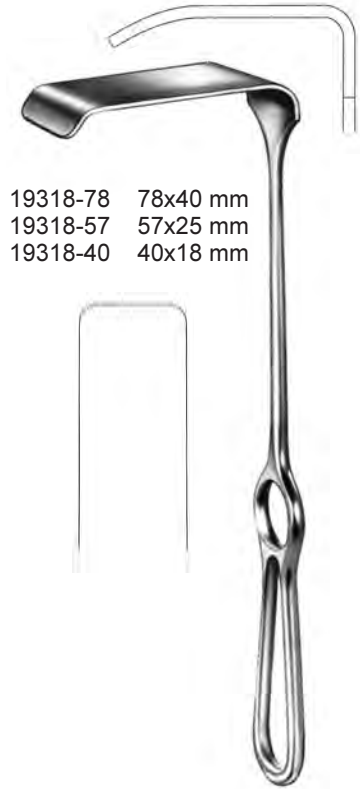

19318-78 78x40 mm
19318-57 57x25 mm
19318-40 40x18 mm

KOCHER
23 cm, 9"

Wundhaken
Retractors
Separadores
Divaricatori

19694-01
50 x 16 mm
20 cm, 8"



19694-02
75 x 25 mm
23 cm, 9"



19694-03
90 x 50 mm
24 cm, 9 1/2"



MEYERDING

Spinalhaken
Spinal retractors
Separadores espinales
Divaricatori spinali



TAYLOR
16,5 cm, 6 1/2"
33831-16 75 x 30 mm
33833-16 100 x 30 mm

Nervhaken, Durahaken
Nerve Hooks, Dura Hooks
Ganchos para nervios y para dura-madre
Unicini per nervi e per dura-madre



DANDY
41051-20
20 cm, 8"



DANDY
41052-20
20 cm, 8"



DANDY
41053-20
20 cm, 8"

Nervhaken, Durahaken
Nerve Hooks, Dura Hooks
Ganchos para nervios y para dura-madre
Unicini per nervi e per dura-madre



CRILE
41054-20
20 cm, 8"

Fig. 1



CUSHING
41056-18 18 cm, 7"
41056-28 28 cm, 11"

Fig. 2



CUSHING
41058-18 18 cm, 7"
41058-28 28 cm, 11"

Nervhaken, Durahaken
Nerve Hooks, Dura Hooks
Ganchos para nervios y para dura-madre
Unicini per nervi e per dura-madre



GRAHAM
41061-16
16,5 cm, 6 1/2"



SACHS
41064-16
18,5 cm, 7 1/4"



ADSON
41068-20
20 cm, 8"



ADSON
41069-20
20 cm, 8"



SMITHWICK
41070-29
29 cm, 11.4"

Nervwurzelhaken
Nerve Root Retractors
Separadores de raiz de nervios
Uncini per le radici dei nervi

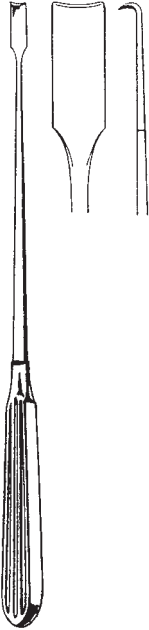

SCOVILLE
41074-23
23 cm, 9"



HOLSHER
41075-24
24 cm, 9 1/2"

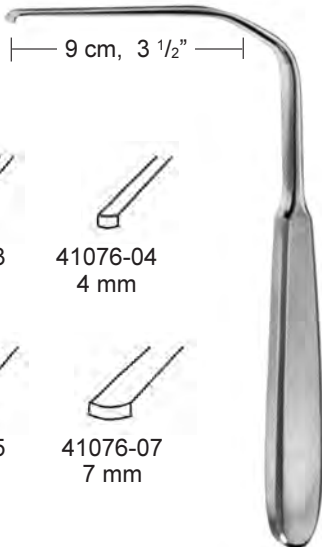

41076-03
3 mm

41076-04
4 mm

41076-05
5 mm

41076-07
7 mm

HESS
17,5 cm, 7"

Nervwurzelnhaken
Nerve Root Retractors
Separadores de raiz de nervios
Uncini per le radici dei nervi



CASPAR
24 cm, 9 1/2"

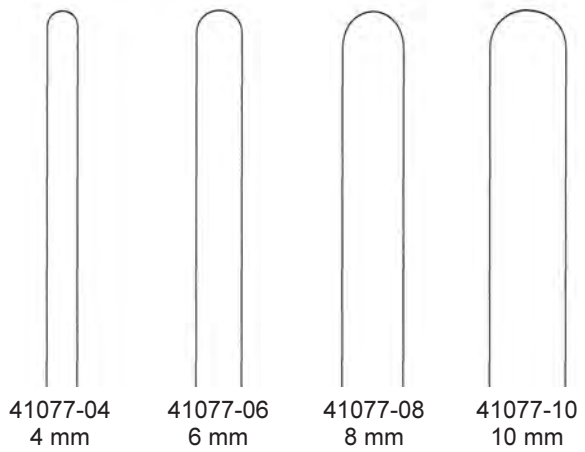

Nervwurzelnhaken
Nerve Root Retractors
Separadores de raiz de nervios
Uncini per le radici dei nervi

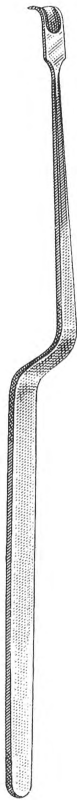

D'ERRICO
41078-23
23 cm, 9"



LOVE
41079-21
21 cm, 8 1/4"

Nervwurzelnhaken, Galea Haken
 Nerve Root Retractors, Galea Hooks
 Separadores de raíz de nervios, Gancho para galea
 Uncini per le radici dei nervi, Uncini galea

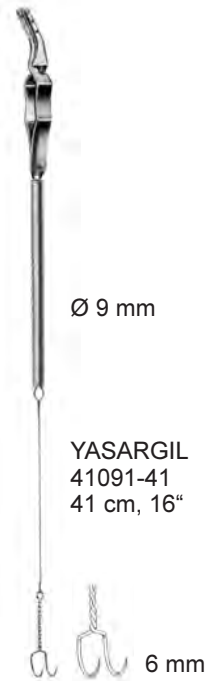
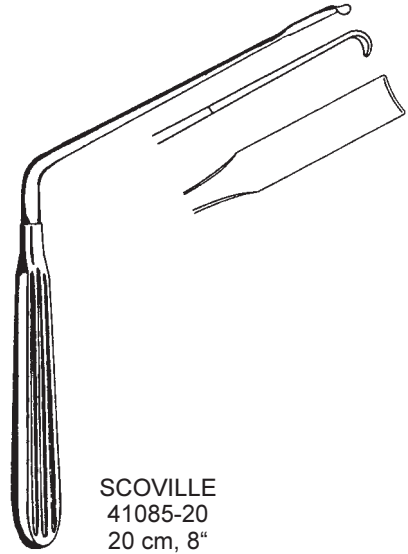
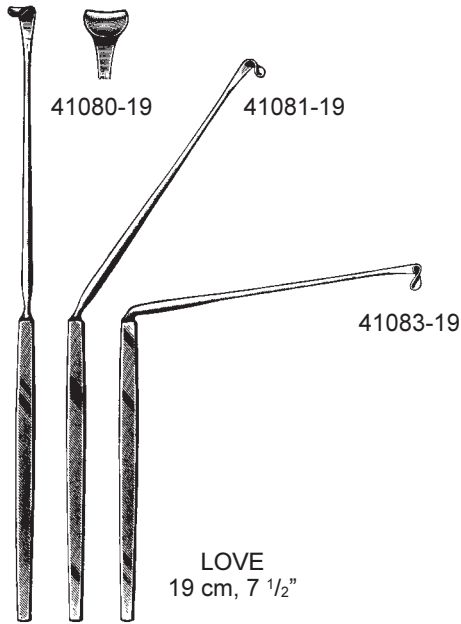

Explorations- und Koagulationshäkchen
 Exploration- and Coagulation Hooks
 Ganchos para exploración y coagulación
 Uncini per esplorazione e coagulazione



CASPAR
 245 mm
 9 3/4"



93400-01 isoliert / insulated
 aislado / isolato

93400-02 nicht isoliert / not insulated
 no-aislado / non isolato



93401-01 isoliert / insulated
 aislado / isolato

93401-02 nicht isoliert / not insulated
 no-aislado / non isolato



93402-01 isoliert / insulated
 aislado / isolato

93402-02 nicht isoliert / not insulated
 no-aislado / non isolato



93403-01 isoliert / insulated
 aislado / isolato

93403-02 nicht isoliert / not insulated
 no-aislado / non isolato

Fadenführer, Nerv- und Gefäßhäkchen
Ligature Guides, Nerve- and Vessel Hooks
Guia para ligaduras, ganchos para nervios y vasos
Conduttori per legature, uncini per nervi e vasi



YASARGIL
185 mm / 7 1/4"
Fadenführer geknöpft
Ligature Guides, probe pointed
Guiador abotonado
Condottoire bottonuto per legature



93405-01



93405-02



93405-03



93405-04



41242-19



41243-19

KRAYENBÜHL
185 mm / 7 1/4"
Nerv- und Gefäßhäkchen
Nerve- and Vessel Hooks
Ganchos para nervios y vasos
Uncini per nervi e vasi



41244-19



41245-19

Griff für auswechselbare Gefäßmesser und Haken
Handle for interchangeable Vessel Knives and Hooks
Mangos para bisturí y ganchos intercambiables
Manico per lame da bisturi e uncini intercambiabili



93440-02 95 mm / 3 ³/₄" JACOBSON

auswechselbares Gefäßmesser für Griff 93440-01
interchangeable vessel knife for handle 93440-01
cuchillo suelto para mango 93440-01
bisturi intercambiabile per manico 93440-01



93440-03 85 mm / 3 ³/₈"





auswechselbares Haken für Griff 93440-01
interchangeable hook for handle 93440-01
cuchillo suelto para mango 93440-01
uncino intercambiabile per manico 93440-01

93440-01
105 mm / 4 ¹/₈"

Griff mit Spannfutter
handle with chuck
mango con chuck
manico con mandrino

Mikro-Häkchen, Mikro-Gefäßmesser
 Micro Hooks, Micro Vessel Knives
 Micro-ganchitos y micro-cuchillos
 Micro uncinetti e micro coltelli per vasi



		93450-01	230 mm / 9"	
			scharf sharp agudo acuto	
		93450-02	230 mm / 9"	
			stumpf blunt romo smusso	
90°		41236-19	185 mm / 7 1/4"	FISCH
			scharf, gebogen sharp, curved agudo, curvado acuto, curva	
90°		41237-19	185 mm / 7 1/4"	FISCH
			scharf, abgewinkelt sharp, angled agudo, angulado acuto, angolato	
		93450-04	185 mm / 7 1/4"	JACOBSON
			Mikro-Gefäßmesser Micro Vessel Knife Micro-cuchillo Micro coltello per vasi	

Reda Instrumente GmbH
Gänsäcker 34 - P.O. Box 131
D-78532 Tuttlingen



SPREIZER

SPREADER

SEPARADORES

DIVARICATORI



www.Reda-Instrumente.de

Wundspreizer
 Self-retaining Retractors
 Separadores autoestáticos
 Divaricatori autostatici

scharf
 sharp
 agudo
 acuto

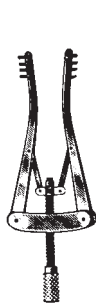

stumpf
 blunt
 romo
 smusso

ALM

19620-07 7 cm, 2 3/4" 19621-07
 19620-10 10 cm, 4" 19621-10

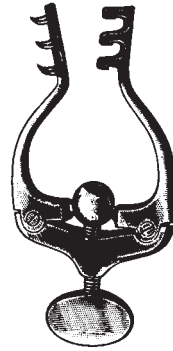

JANSEN
 19630-10
 10 cm, 4"

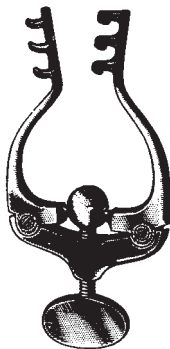

JANSEN
 19631-10
 10 cm, 4"

scharf
 sharp
 agudo
 acuto



stumpf
 blunt
 romo
 smusso

HOLZHEIMER
 19634-10 19635-10
 10 cm, 4"

Wundspreizer
Self-retaining Retractors
Separadores autoestáticos
Divaricatori autostatici

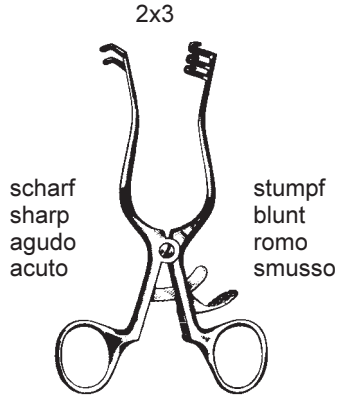

WEITLANER
19650-10 19651-10
11,5 cm, 4 1/2"

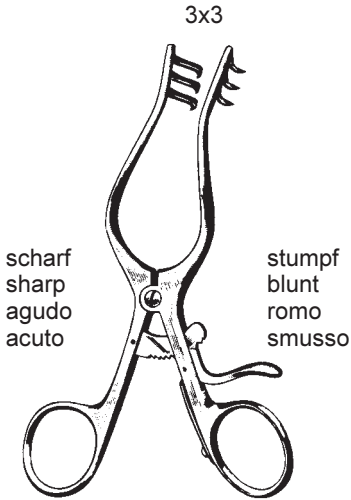

WEITLANER-WULLSTEIN
19654-13 19655-13
13 cm, 5 1/8"

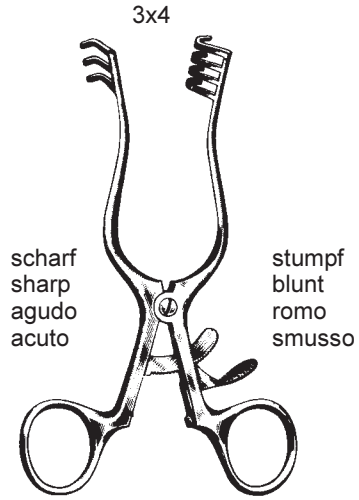

WEITLANER

19670-14	14,0 cm, 5 1/2"	19671-14
19670-16	16,5 cm, 6 1/2"	19671-16
19670-20	20,0 cm, 8"	19671-20
19670-24	24,0 cm, 9 1/2"	19671-24

Wundspreizer
Self-retaining Retractors
Separadores autoestáticos
Divaricatori autostatici

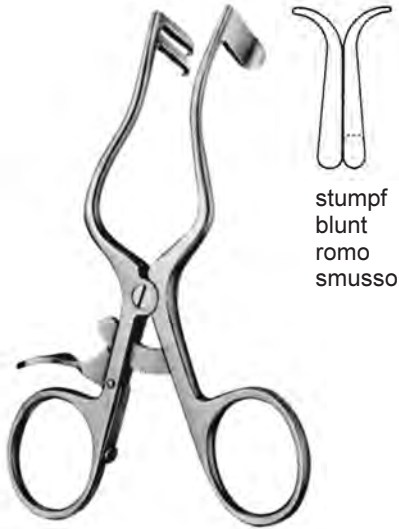

stumpf
blunt
romo
smusso

PLESTER
19672-11 11 cm, 4 3/8"

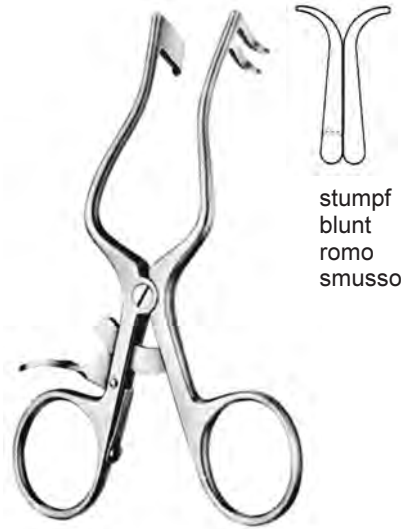

stumpf
blunt
romo
smusso

PLESTER
19673-11 11 cm, 4 3/8"

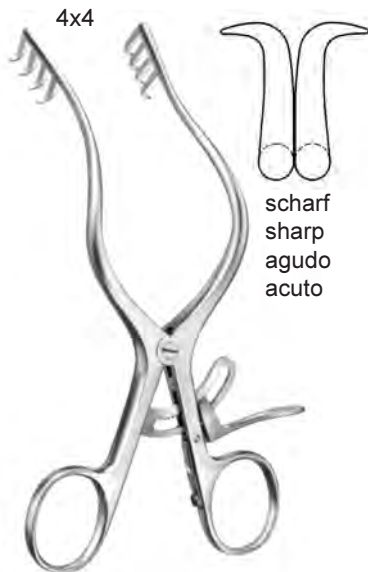

4x4

scharf
sharp
agudo
acuto

MOLLISON
19674-15 15 cm, 6"

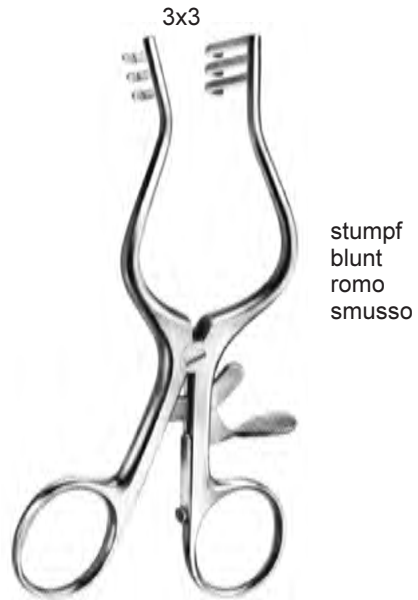

3x3

stumpf
blunt
romo
smusso

WULLSTEIN
19675-13 13 cm, 5 1/8"

Wundspreizer
Self-retaining Retractors
Separadores autoestáticos
Divaricatori autostatici

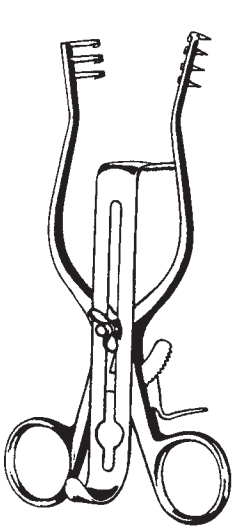

HENLEY
16,5 cm, 6 1/2"

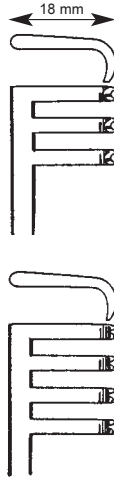

19675-00 komplett, stumpf, 3x4 Z. und 3 Valven
19675-00 complete, blunt, 3x4 teeth and 3 blades
19675-00 completo, romo, 3x4 dientes y 3 valvas
19675-00 completo, smusso, 3x4 d. e 3 valve

19676-00 komplett, scharf, 3x4 Z. und 3 Valven
19676-00 complete, sharp, 3x4 teeth and 3 blades
19676-00 completo, agudo, 3x4 dientes y 3 valvas
19676-00 completo con retr. acuto 3x4 d. e 3 valve

19678-05 Retraktor allein, stumpf 3x4 Zähne
19678-05 Retractor only, blunt 3x4 teeth
19678-05 Separador solo, romo, 3x4 dientes
19678-05 Retrattore solo, smusso 3x4 denti

19678-06 Retraktor allein, scharf 3x4 Zähne
19678-06 Retractor only, sharp 3x4 teeth
19678-06 Separador solo, agudo, 3x4 dientes
19678-06 Retrattore solo, acuto 3x4 denti

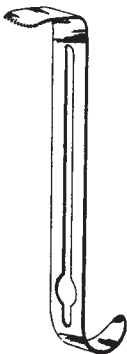

19677-19
16x19 mm
5/8" x 3/4"

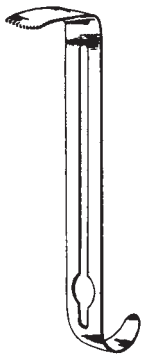

19677-25
16x25 mm
5/8" x 1"

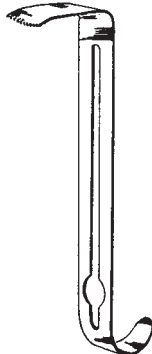

19677-32
16x32 mm
5/8" x 1 1/4"

Wundspreizer
Self-retaining Retractors
Separadores autoestáticos
Divaricatori autostatici



PLESTER
19677-13 13 cm, 5 1/8"

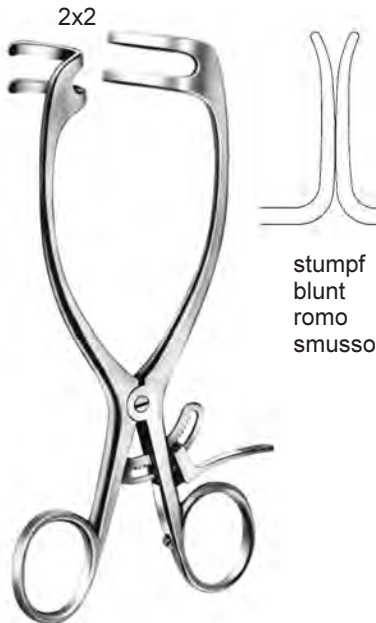

MAYO-ADAMS
19678-16 16,5 cm, 6 1/2"

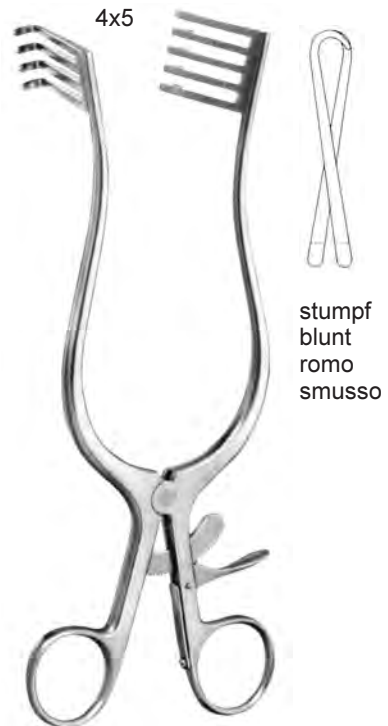

NORFOLK / NORWICH
19679-22 22 cm, 8 3/4"

Wundspreizer
 Self-retaining Retractors
 Separadores autoestáticos
 Divaricatori autostatici



4x4

scharf
 sharp
 agudo
 acuto

ADSON
 19680-19 19 cm, 7 1/2" 19681-19



4x5



stumpf
 blunt
 romo
 smusso

TRAVERS
 19681-21 21,5 cm, 8 1/2"

stumpf
 blunt
 romo
 smusso

Wundspreizer
 Self-retaining Retractors
 Separadores autoestáticos
 Divaricatori autostatici

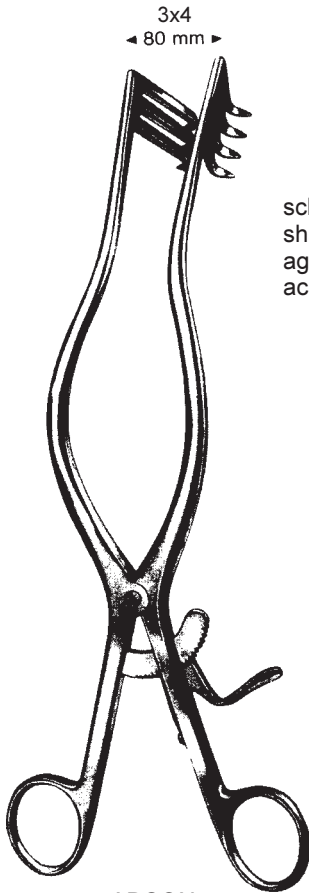

ADSON
 26,5 cm, 10 1/2"

3x4
 ◀ 80 mm ▶

scharf
 sharp
 agudo
 acuto

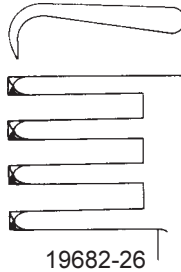

19682-26

stumpf
 blunt
 romo
 smusso

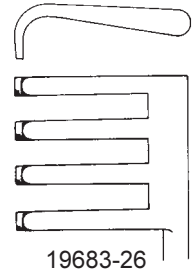

19683-26

- 19684-14 14 cm, 5 1/2"
- 19684-16 16 cm, 6 1/4"
- 19684-20 20 cm, 8"
- 19684-26 26 cm, 10 1/4"

scharf
 sharp
 agudo
 acuto

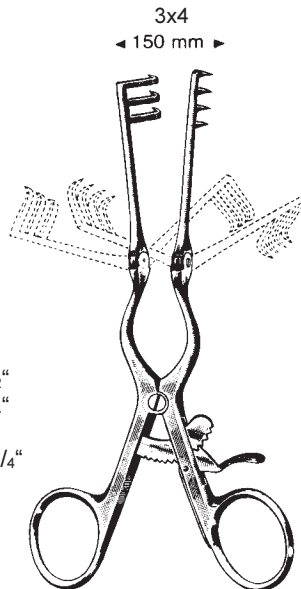

BECKMANN-ADSON (CONE)

3x4
 ◀ 150 mm ▶

- 19685-14 14 cm, 5 1/2"
- 19685-16 16 cm, 6 1/4"
- 19685-20 20 cm, 8"
- 19685-26 26 cm, 10 1/4"

stumpf
 blunt
 romo
 smusso

Kopfhautspreizer
Scalp Retractor
Separador para el cuero cabelludo
Divaricatore automatico per cuoio capelluto

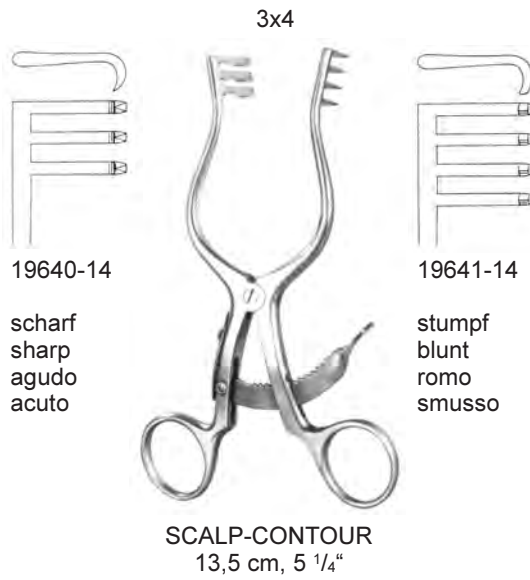

Zerebellum-Spreizer
 Cerebellar Retractor
 Separador para cerebello
 Divaricatore per cervelletto

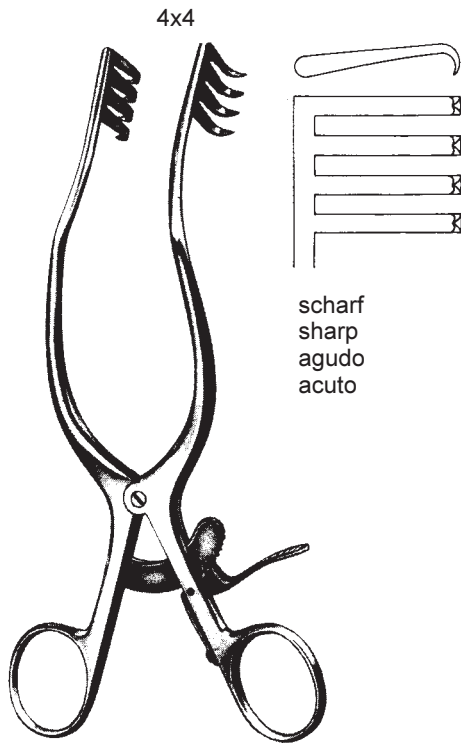

ANDERSON ADSON
 19679-20 19,5 cm, 7 3/4"



MISKIMON
 22 cm, 8 3/4"

19693-01	19693-02
scharf	stumpf
sharp	blunt
agudo	romo
acuto	smusso

Laminektomie-Wundspreizer
Laminectomy Retractors
Separadores para laminectomía
Divaricatori per laminectomia

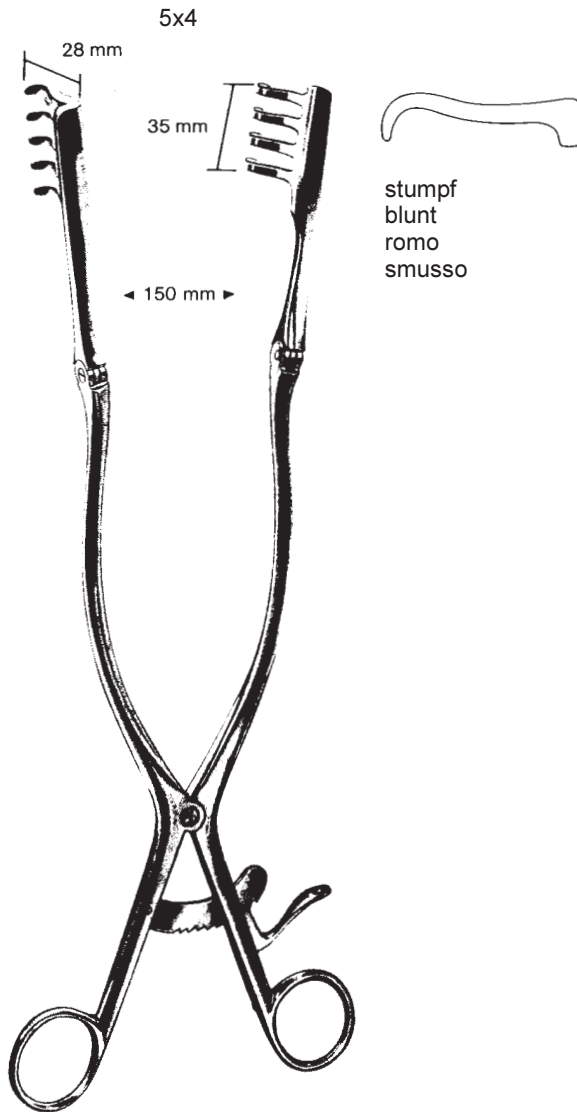

ADSON
19686-32
32 cm, 12 3/4"

Laminektomie-Wundspreizer
Laminectomy Retractors
Separadores para laminectomía
Divaricatori per laminectomia

4x4



BECKMANN-ADSON
31 cm, 12 1/4"

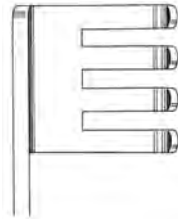

19687-01
25 x 27 mm

stumpf
blunt
romo
smusso

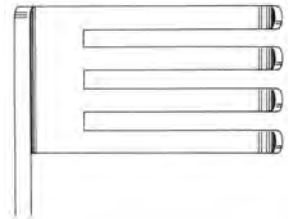

19688-01
45 x 27 mm

stumpf
blunt
romo
smusso

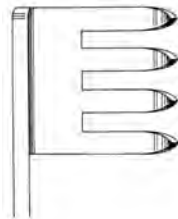

19687-02
25 x 27 mm

scharf
sharp
agudo
acuto

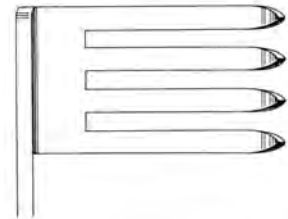

19688-02
45 x 27 mm

scharf
sharp
agudo
acuto

Laminektomie-Wundspreizer
Laminectomy Retractors
Separadores para laminectomía
Divaricatori per laminectomia



28,5 cm, 11 1/4"

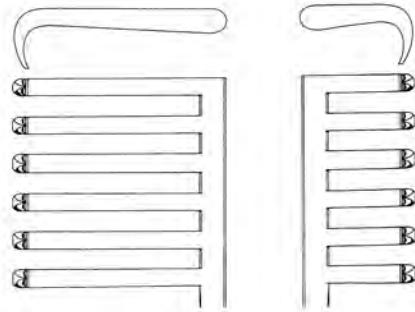

19689-01

scharf, lange Zähne links
sharp, long teeth on left side
agudo, dientes largos a la izquierda
acuto, denti lunghi a sinistra

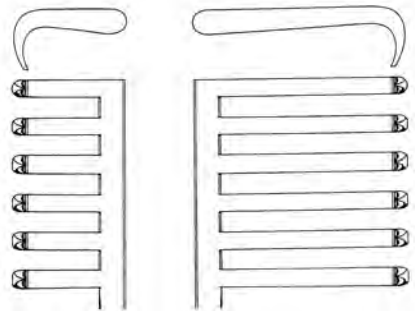

19689-02

scharf, lange Zähne rechts
sharp, long teeth on right side
agudo, dientes largos a la derecha
acuto, denti lunghi a destra

Laminektomie-Wundspreizer
Laminectomy Retractors
Separadores para laminectomía
Divaricatori per laminectomia

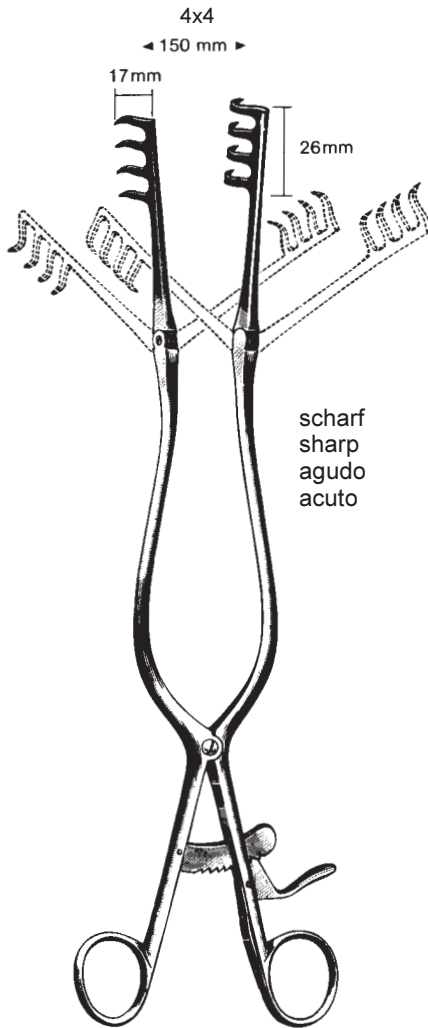

BECKMANN
19690-31
31 cm, 12 1/4"

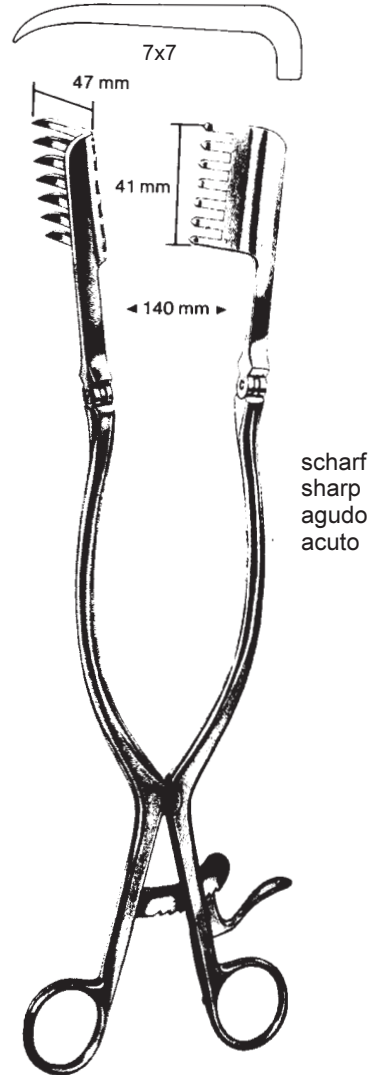

BECKMANN-EATON
19692-32
32 cm, 12 3/4"

Laminektomie-Wundspreizer
Laminectomy Retractors
Separadores para laminectomía
Divaricatori per laminectomia

3x3



scharf
sharp
agudo
acuto

HARVEY-JACKSON
19693-28
28 cm, 11"

Laminektomie-Wundspreizer
Laminectomy Retractors
Separadores para laminectomía
Divaricatori per laminectomia

Blätter rechts
blades right hand side
valvas a la derecha
Lame destra



KNIGHTON
19694-18
18 cm, 7"

Blätter links
blades left hand side
valvas a la izquierda
Lame sinistra



KNIGHTON
19695-18
18 cm, 7"

Laminektomie-Wundspreizer
Laminectomy Retractors
Separadores para laminectomía
Divaricatori per laminectomia

Blätter rechts
blades right hand side
valvas a la derecha
Lame destra



WALTON
19695-01
18 cm, 7"

Blätter links
blades left hand side
valvas a la izquierda
Lame sinistra



WALTON
19695-02
18 cm, 7"

Laminektomie-Wundspreizer
 Laminectomy Retractors
 Separadores para laminectomía
 Divaricatori per laminectomia

19770-00 CASPAR

Sperrer mit Haken 19772-38 und
 5 Blättern 19774-37 - 19774-57
 Retractor with hook 19772-38 and
 5 blades 19774-37 - 19774-57
 Retractor con gancho 19772-38 y
 5 hojas 19774-37 - 19774-57
 Divaricatore con gancio 19772-38 e
 5 valve 19774-37 - 19774-57



19770-11
 Sperrer, alleine
 Retractor, only
 Retractor, suelto
 Divaricatore solo



19779-00
 Drehschlüssel alleine
 Key only
 Llave sola
 Chiave sola



19772-38	Haken	38 mm
	Hook	38 mm
	gancho de	38 mm
	gancio	38 mm
19772-58	Haken	58 mm
	Hook	58 mm
	gancho de	58 mm
	gancio	58 mm



19774-32	32 x 22 mm
19774-37	37 x 22 mm
19774-43	43 x 22 mm
19774-47	47 x 22 mm
19774-52	52 x 22 mm
19774-57	57 x 22 mm
19774-62	62 x 22 mm
19774-67	67 x 22 mm

Blätter / blades
 hojas / valve



19776-32	32 x 37 mm
19776-37	37 x 37 mm
19776-43	43 x 37 mm
19776-47	47 x 37 mm
19776-52	52 x 37 mm
19776-57	57 x 37 mm
19776-62	62 x 37 mm
19776-67	67 x 37 mm

Blätter / blades
 hojas / valve



19778-32	32 x 52 mm
19778-37	37 x 52 mm
19778-43	43 x 52 mm
19778-47	47 x 52 mm
19778-52	52 x 52 mm
19778-57	57 x 52 mm
19778-62	62 x 52 mm
19778-67	67 x 52 mm

Blätter / blades
 hojas / valve

Laminektomiespreizer
Laminectomy Retractors
Separadores para laminectomia
Divaricatori per laminectomia

SCOVILLE-HAVERFIELD
19910-00
Rahmen allein
Frame only
Marco solo
Telaio solo



SCOVILLE
19911-00
Rahmen allein
Frame only
Marco solo
Telaio solo



SCOVILLE-HAVERFIELD
19910-01
komplett bestehend aus:
complete consisting of:
completo con:
completo con:
19910-00 + 19913-50 + 19917-64

SCOVILLE
19911-01
komplett bestehend aus:
complete consisting of:
completo con:
completo con:
19911-00 + 19913-50 + 19917-64



SCOVILLE
19912-50
50 mm



SCOVILLE
19912-70
70 mm



SCOVILLE
19914-41 41 x 38 mm
19914-67 67 x 44 mm



TAYLOR
19915-48 48 x 50 mm
19915-64 64 x 50 mm
19916-64 64 x 64 mm
19916-80 80 x 57 mm



SCOVILLE
19913-50
50 mm



SCOVILLE
19913-70
70 mm



SCOVILLE
19917-64 64 x 25 mm
19918-64 64 x 50 mm
19918-88 88 x 25 mm

Laminektomiespreizer
 Laminectomy Retractors
 Separadores para laminectomia
 Divaricatori per laminectomia

62 x 52 mm 62 x 37 mm



19919-02
 1 Paar / 1 pair / 1 par / 1 paio



19919-03
 47 x 51 mm

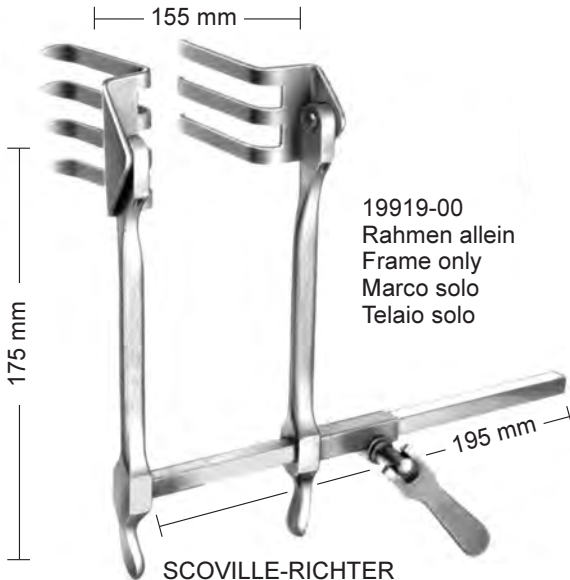

19919-00
 Rahmen allein
 Frame only
 Marco solo
 Telaio solo

SCOVILLE-RICHTER
 19919-01
 komplett / complete / completo / completo



19919-04
 30 x 40 mm



19919-05
 37 x 62 mm

Rahmen mit 1 Paar Valven 19919-02
 frame with one pair of blades 19919-02
 marco con 1 par de valvas 19919-02
 divaricatore con valve 19919-02

Laminektomie-Wundspreizer
Laminectomy Retractors
Separadores para laminectomía
Divaricatori per laminectomia

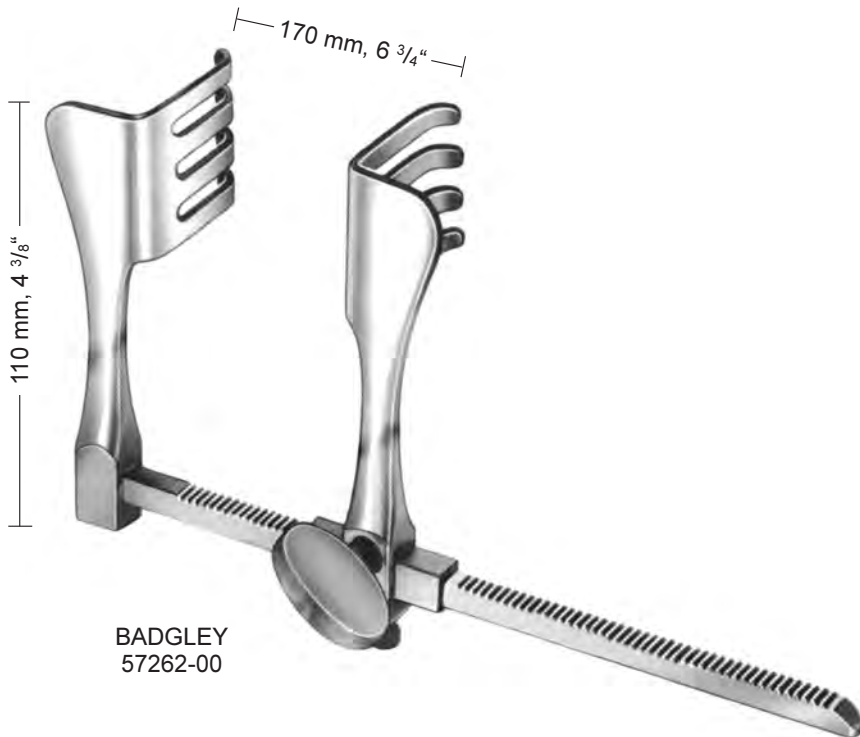

Cervicalspreizer
 Cervical Retractor
 Separador cervical
 Divaricatore cervicale



CLOWARD
 25 cm, 10"



19710-40	40 x 15 / 23 mm
19710-45	45 x 15 / 23 mm
19710-50	50 x 15 / 23 mm
19710-55	55 x 15 / 23 mm
19710-60	60 x 15 / 23 mm

19710-01
 Sperrer, alleine
 Retractor, only
 Retractor, suelto
 Divaricatore solo

19710-00
 Sperrer komplett mit 5 Valven spitz
 Retractor complete with 5 blades sharp
 Separador completo con 5 valvas agudas
 Divaricatore completo con 5 valve acute

Cervicalspreizer
Cervical Retractor
Separador cervical
Divaricatore cervicale



CLOWARD
25 cm, 10"

stumpf
blunt
romo
smusso



19711-40	40 x 15 / 23 mm
19711-45	45 x 15 / 23 mm
19711-50	50 x 15 / 23 mm
19711-55	55 x 15 / 23 mm
19711-60	60 x 15 / 23 mm

19710-01
Sperrer, alleine
Retractor, only
Retractor, suelto
Divaricatore solo

19712-00
Sperrer komplett mit 5 Valven stumpf
Retractor complete with 5 blades blunt
Separador completo con 5 valvas romas
Divaricatore completo con 5 valve smusse

Cervicalspreizer
 Cervical Retractor
 Separador cervical
 Divaricatore cervicale



spitz
 sharp
 agudo
 acuto

23 mm

15 mm



19710-40	40 x 15 / 23 mm
19710-45	45 x 15 / 23 mm
19710-50	50 x 15 / 23 mm
19710-55	55 x 15 / 23 mm
19710-60	60 x 15 / 23 mm

19711-01
 Sperrer, alleine
 Retractor, only
 Retractor, suelto
 Divaricatore solo

CLOWARD
 16 cm, 6 1/4"

19711-00
 Sperrer komplett mit 5 Valven spitz
 Retractor complete with 5 blades sharp
 Separador completo con 5 valvas agudas
 Divaricatore completo con 5 valve acute

Cervicalspreizer
Cervical Retractor
Separador cervical
Divaricatore cervicale

stumpf
blunt
romo
smusso



19711-40	40 x 15 / 23 mm
19711-45	45 x 15 / 23 mm
19711-50	50 x 15 / 23 mm
19711-55	55 x 15 / 23 mm
19711-60	60 x 15 / 23 mm



CLOWARD
16 cm, 6 1/4"

19711-01
Sperrer, alleine
Retractor, only
Retractor, suelto
Divaricatore solo

19713-00
Sperrer komplett mit 5 Valven stumpf
Retractor complete with 5 blades blunt
Separador completo con 5 valvas romas
Divaricatore completo con 5 valve smusse

Cervicalspreizer
Cervical Retractor
Separador cervical
Divaricatore cervicale

90 mm, 3 1/2"



CASPAR
19721-15
165 mm, 5 1/2"
Sperrer, alleine
Retractor, only
Retractor, suelto
Divaricatore solo



19726-01
Blätter-Wechselpinzette
Blade ejector
Pinza para cambiar hojas
Pinze per cambiare valve

19721-00 compl.
5 Valven / 5 blades / 5 valvas / 5 valve
Blätter, stumpf / blunt blades, only stainless steel /
hojas romas de acero inox. / valve smusse di acciaio inox

19738-45 45 x 23 mm
19738-50 50 x 23 mm
19738-55 55 x 23 mm
19738-60 60 x 23 mm
19738-65 65 x 23 mm



Titan Blätter, gefenstert
 Titanium blades, fenestrated
 Valvas de titanio, fenestradas
 Valve de titanio, fenestrated

- 19 mm x 25 mm 19727-25T
- 19 mm x 30 mm 19727-30T
- 19 mm x 35 mm 19727-35T
- 19 mm x 40 mm 19727-40T
- 19 mm x 45 mm 19727-45T
- 19 mm x 50 mm 19727-50T
- 19 mm x 55 mm 19727-55T
- 19 mm x 60 mm 19727-60T

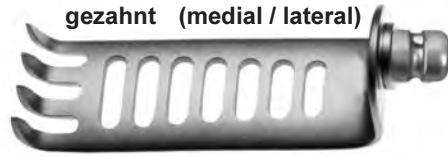

- 19 mm x 25 mm 19728-25T
- 19 mm x 30 mm 19728-30T
- 19 mm x 35 mm 19728-35T
- 19 mm x 40 mm 19728-40T
- 19 mm x 45 mm 19728-45T
- 19 mm x 50 mm 19728-50T
- 19 mm x 55 mm 19728-55T
- 19 mm x 60 mm 19728-60T

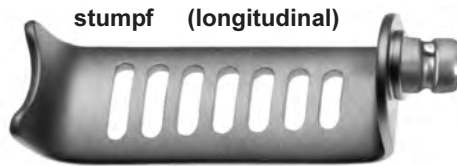

- 24 mm x 30 mm 19729-30T
- 24 mm x 35 mm 19729-35T
- 24 mm x 40 mm 19729-40T
- 24 mm x 45 mm 19729-45T
- 24 mm x 50 mm 19729-50T
- 24 mm x 55 mm 19729-55T
- 24 mm x 60 mm 19729-60T
- 24 mm x 65 mm 19729-65T
- 24 mm x 70 mm 19729-70T



- 24 mm x 30 mm 19730-30T
- 24 mm x 35 mm 19730-35T
- 24 mm x 40 mm 19730-40T
- 24 mm x 45 mm 19730-45T
- 24 mm x 50 mm 19730-50T
- 24 mm x 55 mm 19730-55T
- 24 mm x 60 mm 19730-60T
- 24 mm x 65 mm 19730-65T
- 24 mm x 70 mm 19730-70T

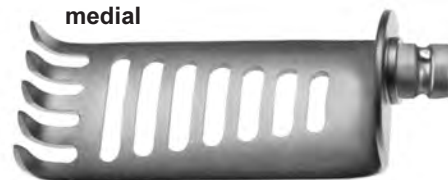

- 24 mm x 35 mm 19731-35T
- 24 mm x 40 mm 19731-40T
- 24 mm x 45 mm 19731-45T
- 24 mm x 50 mm 19731-50T
- 24 mm x 55 mm 19731-55T
- 24 mm x 60 mm 19731-60T
- 24 mm x 65 mm 19731-65T
- 24 mm x 70 mm 19731-70T
- 24 mm x 75 mm 19731-75T

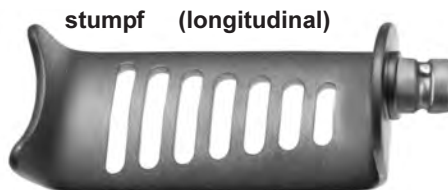

Blätter für Cervicalspreizer
 Blades for cervical Retractors
 Hojas sueltas para separador cervical
 Valve per divaricatori cervicale



19724-55
 55 x 20 mm

Blätter, medial / medial blades, only stainless steel /
 hojas mediales de acero inox. / valve mediali di acciaio inox

19724-40	40 x 23 mm	19724-55	55 x 23 mm
19724-45	45 x 23 mm	19724-60	60 x 23 mm
19724-50	50 x 23 mm		

Blätter, medial, TITAN / medial blades, only, TITANIUM /
 hojas mediales de TITANIO / valve mediali di TITANIO

19732-25 T	25 x 24 mm	19732-50 T	50 x 24 mm
19732-30 T	30 x 24 mm	19732-55 T	55 x 24 mm
19732-35 T	35 x 24 mm	19732-60 T	60 x 24 mm
19732-40 T	40 x 24 mm	19732-65 T	65 x 24 mm
19732-45 T	45 x 24 mm	19732-70 T	70 x 24 mm



19734-50
 50 x 23 mm

Blätter, lateral / lateral blades, only stainless steel /
 hojas laterales de acero inox. / valve laterali di acciaio inox

19725-40	40 x 23 mm	19725-55	55 x 23 mm
19725-45	45 x 23 mm	19725-60	60 x 23 mm
19725-50	50 x 23 mm		

Blätter, lateral, TITAN / lateral blades, only, TITANIUM /
 hojas laterales de TITANIO / valve laterali di TITANIO

19736-25 T	25 x 24 mm	19736-50 T	50 x 24 mm
19736-30 T	30 x 24 mm	19736-55 T	55 x 24 mm
19736-35 T	35 x 24 mm	19736-60 T	60 x 24 mm
19736-40 T	40 x 24 mm	19736-65 T	65 x 24 mm
19736-45 T	45 x 24 mm	19736-70 T	70 x 24 mm



19738-55
 55 x 23 mm

Blätter, stumpf / blunt blades, only stainless steel /
 hojas romas de acero inox. / valve smusse di acciaio inox

19738-45	45 x 23 mm	19738-60	60 x 23 mm
19738-50	50 x 23 mm	19738-65	65 x 23 mm
19738-55	55 x 23 mm		

Blätter, stumpf, TITAN / blunt blades, only, TITANIUM /
 hojas romas de TITANIO / valve smusse di TITANIO

19739-30 T	30 x 24 mm	19739-55 T	55 x 24 mm
19739-35 T	35 x 24 mm	19739-60 T	60 x 24 mm
19739-40 T	40 x 24 mm	19739-65 T	65 x 24 mm
19739-45 T	45 x 24 mm	19739-70 T	70 x 24 mm
19739-50 T	50 x 24 mm	19739-75 T	75 x 24 mm



Blätter, stumpf / blunt blades, only stainless steel /
 hojas romas de acero inox. / valve smusse di acciaio inox

19740-50	50 x 25 mm
19740-60	60 x 25 mm

Hemilaminectomiespreizer
Hemilaminectomy Retractor
Separadores para hemilaminectomía
Divaricatori per emilaminectomia

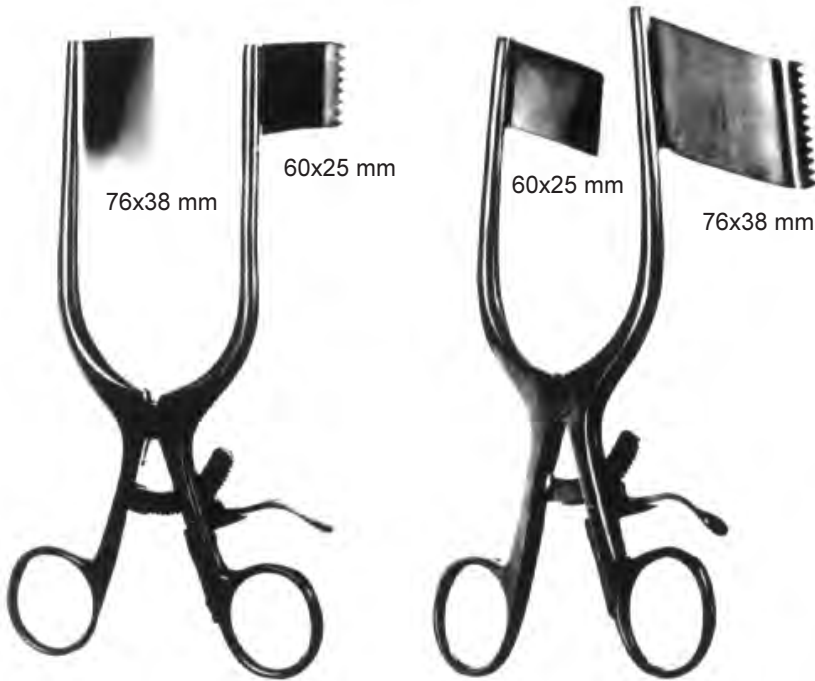

DARLING
19696-18 18 cm, 7"

links
left
a la izquierda
a sinistra

DARLING
19698-18 18 cm, 7"

rechts
right
a la derecha
a destra

Hemilaminectomiespreizer
Hemilaminectomy Retractor
Separadores para hemilaminectomía
Divaricatori per emilaminectomia

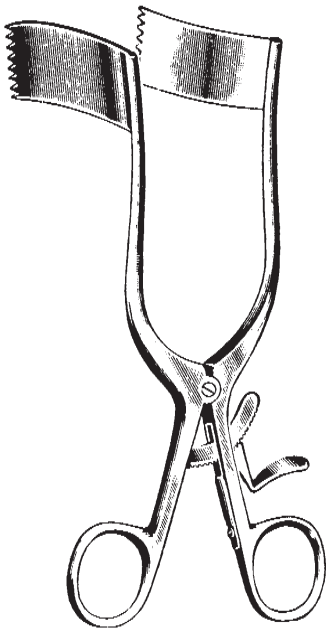

MEYERDING
17 cm, 6 ³/₄"
19748-01 2,5 x 3,2 cm
19748-02 2,5 x 5,4 cm
19748-03 1,9 x 6,0 cm
19748-04 2,5 x 6,0 cm



MARKHAM-MEYERDING
19749-01
18 cm, 7"



MARKHAM-MEYERDING
19749-02
18 cm, 7"

Hemilaminectomiespreizer
Hemilaminectomy Retractor
Separadores para hemilaminectomía
Divaricatori per emilaminectomia



WILLIAMS
20 cm, 8"

50 x 10 mm	19750-01
60 x 10 mm	19750-02
70 x 10 mm	19750-03
50 x 20 mm	19750-04
60 x 20 mm	19750-05
70 x 20 mm	19750-06

links
left
a la izquierda
a sinistra



WILLIAMS
20 cm, 8"

50 x 10 mm	19751-01
60 x 10 mm	19751-02
70 x 10 mm	19751-03
50 x 20 mm	19751-04
60 x 20 mm	19751-05
70 x 20 mm	19751-06

rechts
right
a la derecha
a destra

Wundspreizer
Retractors
Separadores
Divaricatori

< 100 mm >

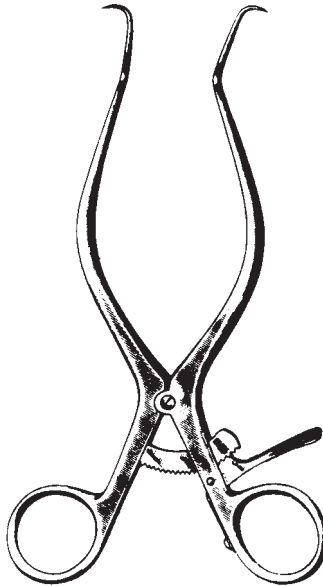

GELPI

19802-09	9 cm, 3 1/2"
19802-11	11 cm, 4 3/8"
19802-14	14 cm, 5 1/2"
19802-16	16 cm, 6 1/4"
19802-18	18 cm, 7"

Lamina Spreizer
Lamina Retractor
Separadores para vertebrales
Separatori per vertebre



CLOWARD
41401-16
16 cm, 6 1/4"

Lamina Spreizer
Lamina Retractor
Separadores para vertebrales
Separatori per vertebre

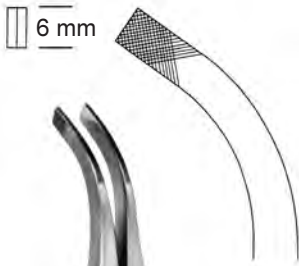

INGE
41405-17
17 cm, 6 ³/₄"

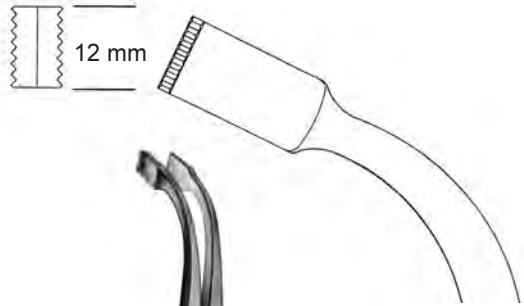

INGE
41405-27
27 cm, 10 ¹/₂"

Lamina Spreizer
Lamina Retractor
Separadores para vertebrales
Separatori per vertebre



19 mm

CLOWARD
41406-01
12,5 cm, 5"



38 mm

CLOWARD
41406-02
7,6 cm, 3"

Lumbal-Wundspreizer
Lumbal Retractors
Separadores lumbales autoestáticos
Divaricatori autostatici lombari



19745-40
40 mm, 1 1/2"



19745-45
45 mm, 1 3/4"



19745-60
60 mm, 2 1/4"



19745-50
50 mm, 2"



19745-65
65 mm, 2 1/2"



19745-55
55 mm, 2 1/8"



19745-70
70 mm, 2 3/4"

CASPAR
19744-00
compl. incl. 7 Blätter
compl. incl. 7 blades
completo con 7 valvas
complete di 7 valve

19744-17
ohne Blätter
without blades
sin valvas
senza valve

Spekula für lumbale Bandscheibenoperationen
Specula for lumbar operations
Especulas para operaciones lumbales
Specolo per ernia discale lombare



CASPAR

19748-40	40 mm / 1 1/2"
19748-45	45 mm / 1 3/4"
19748-50	50 mm / 2"
19748-55	55 mm / 2 1/8"
19748-60	60 mm / 2 1/4"
19748-65	65 mm / 2 1/2"
19748-70	70 mm / 2 3/4"
19748-75	75 mm / 3"
19748-85	85 mm / 3 1/4"



Lumbal-Wundspreizer
 Lumbal Retractors
 Separadores lumbales autoestáticos
 Divaricatori autostatici lombari

19726-01 Blätter-Wechselpinzette
 Blade ejector
 Pinza para cambiar hojas
 Pinze per cambiare valve



60 mm



19742-35 35 mm
 19742-40 40 mm
 19742-45 45 mm
 19742-50 50 mm
 19742-55 55 mm
 19742-60 60 mm



Valven, lateral / blades, lateral
 valvas, laterales / valve, laterali

19930-00 Gegensperrer, komplett mit 6 Blättern
 Counter Retractor, complete with 6 blades
 Contra-retractor, completo, con 6 hojas
 Divaricatore completo di 6 valve

19930-01 Gegensperrer, alleine
 Counter Retractor, only
 Contra-retractor, suelto
 Divaricatore solo

Lumbal-Wundspreizer
Lumbal Retractors
Separadores lumbal
Divaricatore lombare



19742-35	35 mm / 1 1/4"
19742-40	40 mm / 1 1/2"
19742-45	45 mm / 1 3/4"
19742-50	50 mm / 2"
19742-55	55 mm / 2 1/8"
19742-60	60 mm / 2 1/4"
19742-65	65 mm / 2 1/2"
19742-75	75 mm / 3"
19742-85	85 mm / 3 1/4"

Blätter alleine, lateral
blades only, lateral
hojas sueltas, lateral
valve sole, laterale



19743-35	35 mm / 1 1/4"
19743-40	40 mm / 1 1/2"
19743-45	45 mm / 1 3/4"
19743-50	50 mm / 2"
19743-55	55 mm / 2 1/8"
19743-60	60 mm / 2 1/4"
19743-65	65 mm / 2 1/2"

Blätter alleine, medial
blades only, medial
hojas sueltas, medial
valve sole, mediali

Cervicales Wirbelkörper Distraktions System
Cervical Vertebral Body Distraction System
Cervical Sistema de distracción vertebral
Sistema di distrazione vertebrale cervicale



CASPAR
19920-01

- 19920-01 Distraktor alleine, rechts
Distractor only, right
Distractor suelto, lado derecho
Distrattore solo, a destra
- 19920-02 Distraktor alleine, links
Distractor only, left
Distractor suelto, lado izquierdo
Distrattore solo, a sinistra
- 19930-03 Distraktor alleine, rechts mit verlängerter Führungsstange für mehrere Distraktionen
Distractor only, right with elongated toothed bar for multilevel distraction
Distractor suelto, lado derecho, con guía alargada para distracciones multiples
Distrattore solo, a destra, allungato, per multi-distrazioni
- 19930-02 Distraktor alleine, links
Distractor only, left
Distractor suelto, lado izquierdo
Distrattore solo, a sinistra

Cervicales Wirbelkörper Distraktions System
Cervical Vertebral Body Distraction System
Cervical Sistema de distracción vertebral
Sistema di distrazione vertebrale cervicale



19940-01

19940-01

Bohrlehre, rechts, für Distraktor 19920-01 + 19930-01

Drill guide, right, for distractor 19920-01 + 19930-01

Guía, lado derecho, para distractor 19920-01 + 19930-01

Guida a destra per distrattore 19920-01 + 19930-01

19940-02

Bohrlehre, links, für Distraktor 19920-02 + 19930-02

Drill guide, left, for distractor 19920-02 + 19930-02

Guía, lado izquierdo, para distractor 19920-02 + 19930-02

Guida a sinistra per distrattore 19920-02 + 19930-02

Wirbelkörper Distraktions System
Vertebral Body Distraction System
Sistema de distracción vertebral
Sistema di distrazione vertebrale



Bohrer Ø 1,7 mm
für Distraktionsschrauben
Bohrtiefe 8 mm
Twist drill Ø 1,7 mm
for distraction screws
drilling depth: 8 mm
perforador Ø 1,7 mm
para tornillos de distracción
profundidad de 8 mm
perforatore Ø 1,7 mm
per viti di distrazione
profondità 8 mm

19950-14
145 mm
5 3/4"



Schraubendreher
für Distraktionsschrauben
Screw driver
for distraction screws
Atornillador
para tornillos de distracción
Cacciavite
per viti di distrazione

19960-20
200 mm
8"



19970-12 12 mm
19970-14 14 mm
19970-16 16 mm
19970-18 18 mm

Distraktionsschrauben
Distraction screws
Tornillos de distracción
Vite distrattore

Reda Instrumente GmbH
Gänsäcker 34 - P.O. Box 131
D-78532 Tuttlingen



ZANGEN

FORCEPS

PINZAS

PINZE



www.Reda-Instrumente.de

Hohlmeißelzangen
Bone Rongeurs
Pinzas-gubias
Pinze sgorbie

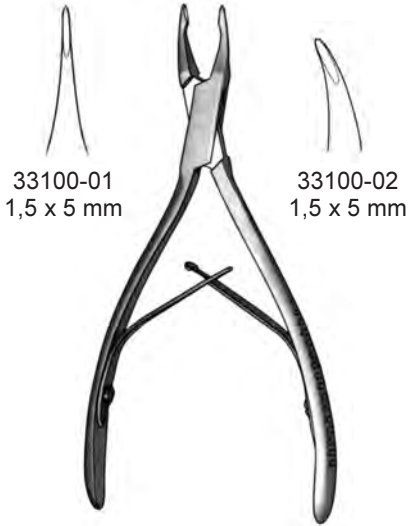

MICRO FRIEDMAN
14 cm, 5 1/2"



FRIEDMAN Mini
33101-12 12 cm, 4 3/4"



FRIEDMAN
33101-14 14 cm, 5 1/2"

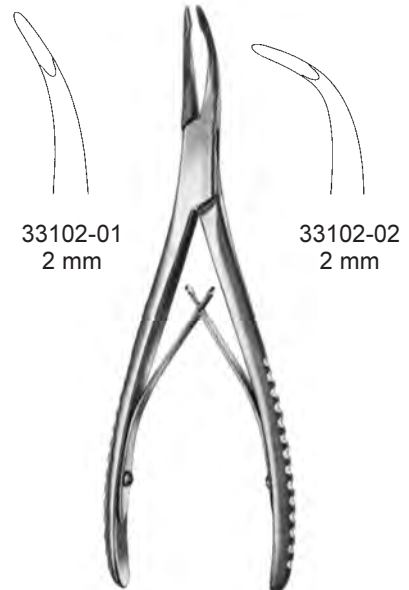

STELLBRINK
17 cm, 6 3/4"

Hohlmeißelzangen
 Bone Rongeurs
 Pinzas-gubias
 Pinze sgorbie



4,5 mm

LUER
 33131-15 15 cm, 5.9"

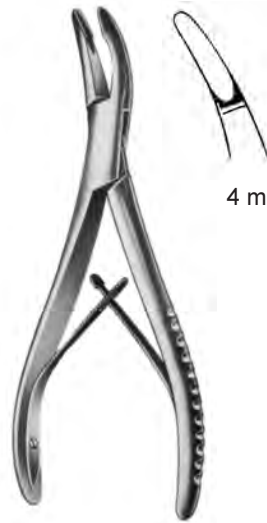

4 mm

LUER
 33133-15 15 cm, 5.9"

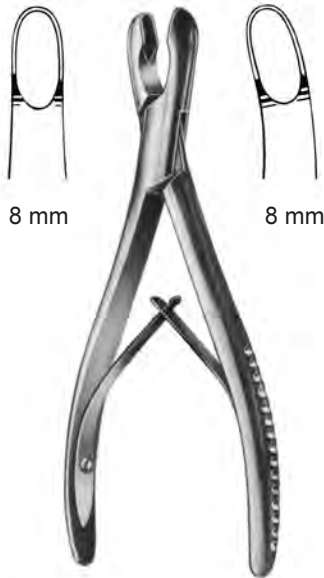

8 mm

8 mm

LUER
 33136-17 33137-17
 17 cm, 6 3/4"



9 mm

ADSON
 33142-20 33143-20
 20 cm, 7.9"

Hohlmeißelzangen
 Bone Rongeurs
 Pinzas-gubias
 Pinze sgorbie



6 mm

OLIVECRONA
 33147-20 20 cm, 7.9"



4,5 mm

BANE-HARTMANN
 33148-18 17,5 cm, 7"



3 mm

— LEMPERT —
 33150-16 33151-16
 16 cm, 6 1/4"



5 mm

— JANSEN —
 33152-17 33153-17
 17 cm, 6 3/4"

Hohlmeißelzangen
Bone Rongeurs
Pinzas-gubias
Pinze sgorbie



3 mm

— LEMPERT —
33154-18 33155-18
18,5 cm, 7 1/4"



3 mm

BEYER
33156-18
18 cm, 7"

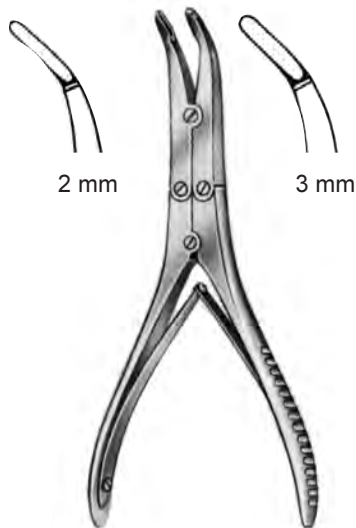

2 mm

3 mm

KLEINERT-KUTZ
33157-02 33157-03
15 cm, 6"

Hohlmeißelzangen
 Bone Rongeurs
 Pinzas-gubias
 Pinze sgorbie

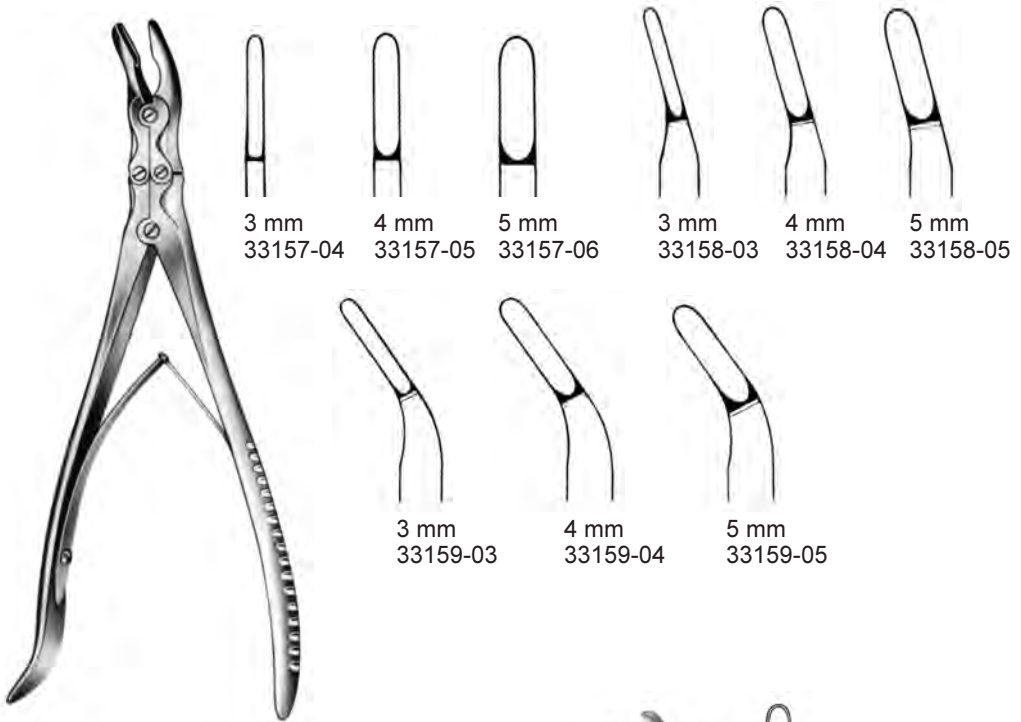

SMITH-PETERSEN
 24 cm, 9 1/2"



BACON
 33159-20
 20 cm, 8"

Hohlmeißelzangen
 Bone Rongeurs
 Pinzas-gubias
 Pinze sgorbie



BEYER
 33201-18
 18 cm, 7"



MAYFIELD
 33202-18
 18 cm, 7"



ZAUFAL-JANSEN
 33205-18
 18 cm, 7"



— BÖHLER —
 33211-15 33213-15
 15 cm, 6"

Hohlmeißelzangen
Bone Rongeurs
Pinzas-gubias
Pinze sgorbie

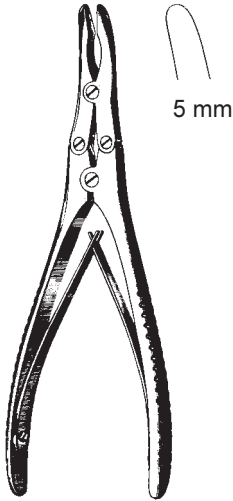

— RUSKIN —
33216-18 33217-18
18 cm, 7"

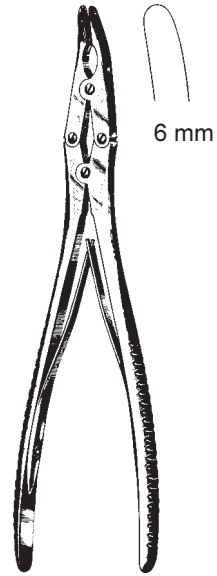

RUSKIN
33219-23 23 cm, 9"



MARQUARDT
33220-20 20 cm, 8"

Hohlmeißelzangen
 Bone Rongeurs
 Pinzas-gubias
 Pinze sgorbie

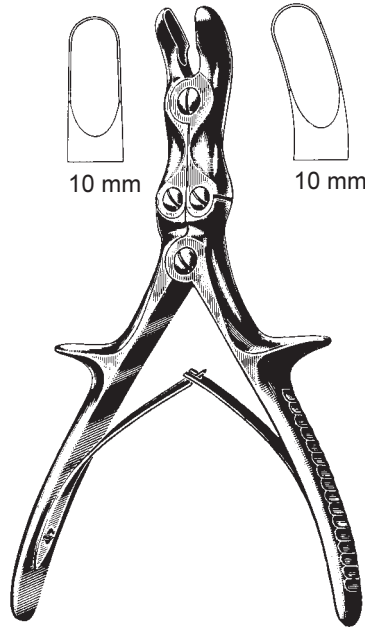

STILLE-LUER
 33230-22 22 cm, 8 ³/₄" 33231-22
 33230-26 26 cm, 10 ¹/₄" 33231-26

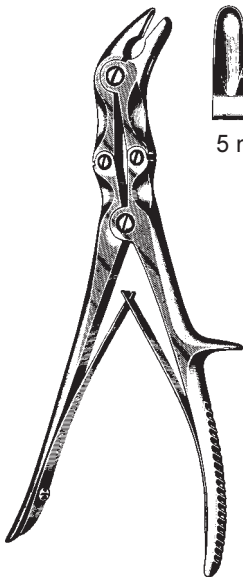

STILLE-LUER
 33235-23
 23 cm, 9"

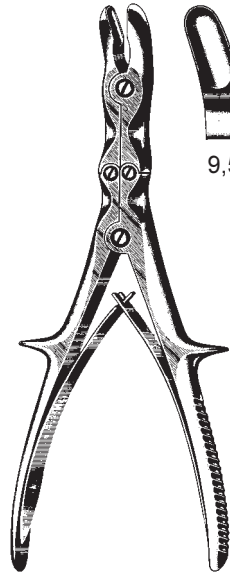

STILLE-RUSKIN
 33237-23
 23 cm, 9"

Hohlmeißelzangen
Bone Rongeurs
Pinzas-gubias
Pinze sgorbie

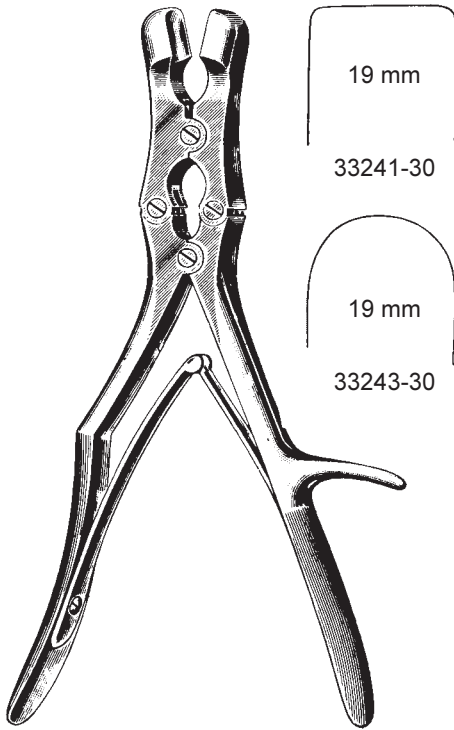

SAUERBRUCH
30 cm, 10 3/4"

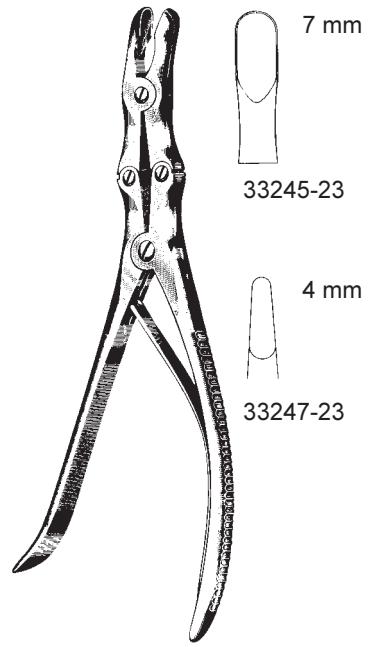

LEKSELL (STILLE)
23 cm, 9"

Hohlmeißelzangen
Bone Rongeurs
Pinzas-gubias
Pinze sgorbie



ECHLIN
23 cm, 9"



33257-23 2 mm



33258-23 4 mm



33259-23 3 mm



FRYKHOLM
33260-24
24 cm, 9 1/2"



4,5 mm



SEMB
33261-22
22,5 cm, 8.9"



17 mm

Knochensplitterzangen
 Bone Cutting Forceps
 Pinzas cortantes para huesos
 Cesoie per ossa

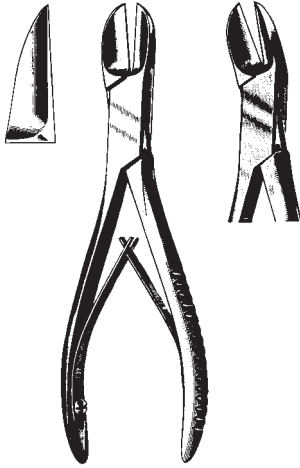

— LISTON —

33274-14 14 cm, 5 1/2" 33275-14
 33274-17 17 cm, 6 3/4" 33275-17
 33274-19 19 cm, 7 1/2" 33275-19



— BÖHLER —

33280-15 33281-15
 15 cm, 6"



COTTLE-KAZANJIAN

33282-19
 19 cm, 7 1/2"



MC INDOE
 33283-17
 17 cm, 6 3/4"



STAMM
 33284-15
 15 cm, 6"



— RUSKIN-LISTON —
 33286-18 33289-18
 18 cm, 7"

Knochensplitterzangen
Bone Cutting Forceps
Pinzas cortantes para huesos
Cesoie per ossa



— STILLE-LISTON —
33290-23 23 cm, 9" 33291-23
33290-27 27 cm, 10 1/2" 33291-27



STILLE-LISTON
33292-26
26 cm, 10 1/4"



STILLE-HORSLEY
33293-27
27 cm, 10 1/2"



SEMB
33295-24
24 cm, 9 1/2"

Anlegezangen, Klammerblock
 Applying Forceps, Clip Rack
 Pinzas aplicadoras, riel para grapas
 Pinza per applicare, porta-fermagli

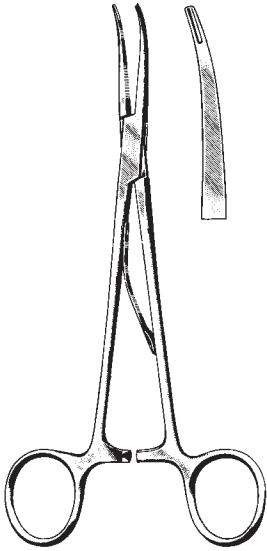

McKENZIE

41011-15 15 cm, 6"
 41011-19 19 cm, 7 1/2"

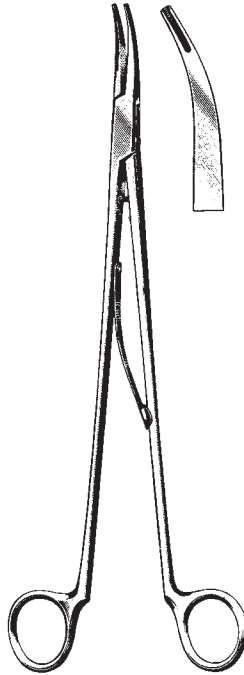

SMITHWICK

41015-23 23 cm, 9"
 41015-26 26 cm, 10 1/4"

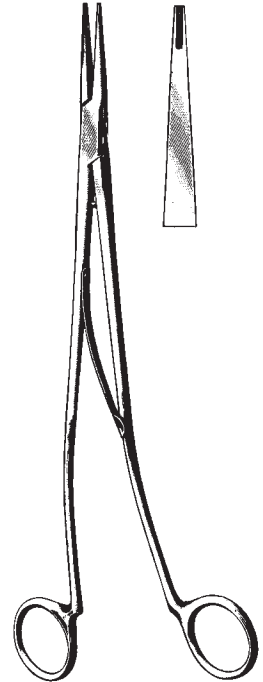

SWEET

41017-23 23 cm, 9"
 41017-26 26 cm, 10 1/4"



OLIVECRONA-TOENNIS
 41019-14

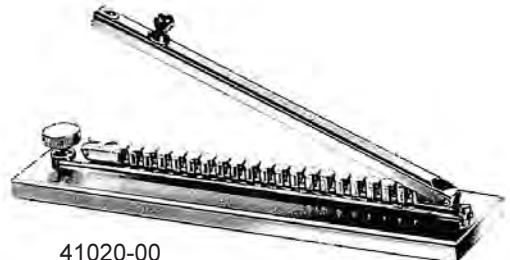

41020-00
 148 x 40 x 6 mm



Reda Instrumente GmbH
Gänsäcker 34 - P.O. Box 131
D-78532 Tuttlingen

**SCHÄDELHALTER
DRAHTSÄGEN
TREPHEINEN**

**SKULL HOLDER
WIRE SAWS
TREPHEINE**

**CRÁNEO TITULAR
ALAMBRE DE SIERRAS
TREPANO**

**SKULL TITOLARE
SEGHE A FILO
TRAPANO**



www.Reda-Instrumente.de

Schädelhalter, Kopfhautklammer, Anlegezange
Cervical Traction Tongs, Clips, Applying Forceps
Pinzas de tracción craneal, Clips, pinza aplicadora para clips
Arco per trazione craniale, Pinza applicatrice

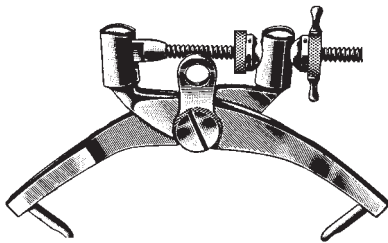

CRUTCHFIELD
41025-01



CRUTCHFIELD
41025-02



41026-35
3,5 mm Ø



41026-50
5 mm Ø

Stainless steel
Acciaio inox
acero inoxidable



RANEY
41027-00

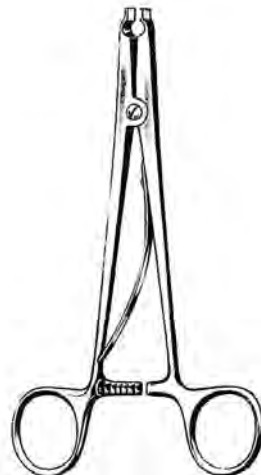

RANEY
41028-00 16 cm, 6 1/4"

Drahtsägen, Einführungsinstrument
 Wire Saws, Guiding Instruments
 Sierras de hilo de metal, Instrumentos para su introducción
 Seghe di filo d'acciaio, Strumenti introduttori



DeMARTEL
 41090-33
 33 cm, 13"

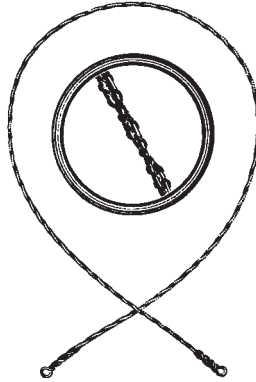

OLIVECRONA	cm	
41092-30	30,	11 3/4"
41092-40	40,	15 3/4"
41092-50	50,	19 3/4"
41092-60	60,	23 3/4"
41092-70	70,	27 1/2"



GIGLI STRULLY
 41093-00



GIGLI
 41094-00

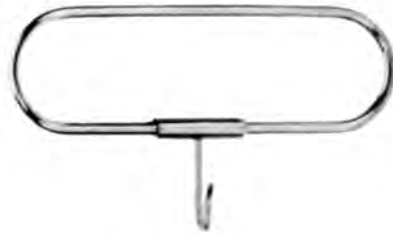

REDA
 41095-00

Schädelzange
Skull Punches
Pinzas sacabocado craneal
Pinza per craniotomia

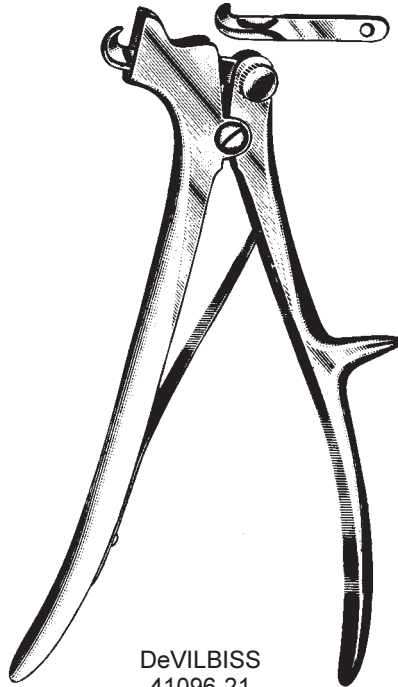

DeVILBISS
41096-21
21 cm, 8 1/4"

Schädelstanze
Cranial Punch
Pinzas sacabocado craneal
Pinza per craniotomia



CONE
41097-22
22,5 cm 9"

Bohrloch-Schutzzange
Bore hole protection Forceps
Pinzas para la protección de orificio
Pinze per la protezione del foro



41098-20
20,5 cm 8"

Schädeltrephine
Skull Trepine
Trépanos craneales
Trapano cranico

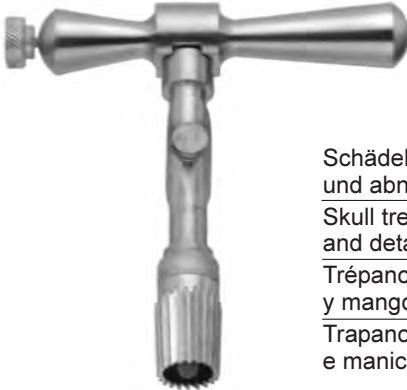

Schädeltrephine mit verstellbarem Dorn
und abnehmbarem Quergriff

Skull trephines with adjustable centering point
and detachable cross-bar handle

Trépano craneal con guia-central ajustable
y mango transversal desmontable

Trapano cranico con punta regolabile
e manico trasversale smontabile

GALT

34816-13 Ø 13 mm

34816-16 Ø 16 mm

34816-19 Ø 19 mm

Bohrlochzange
Drill Guide and Dura Protecting Forceps
Pinza guía taladros y protectora de duramadre
Pinze guida-perforatore e proteggi dura-madre

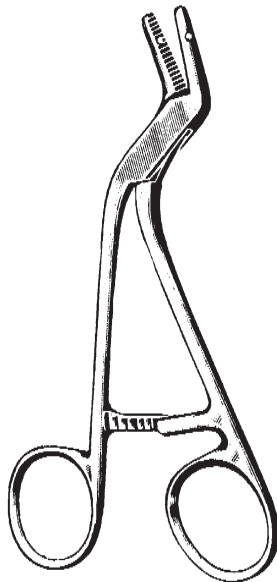

ADSON
34231-15
15 cm, 6"

Trepine
Trepine
Trepano
Punta trapano

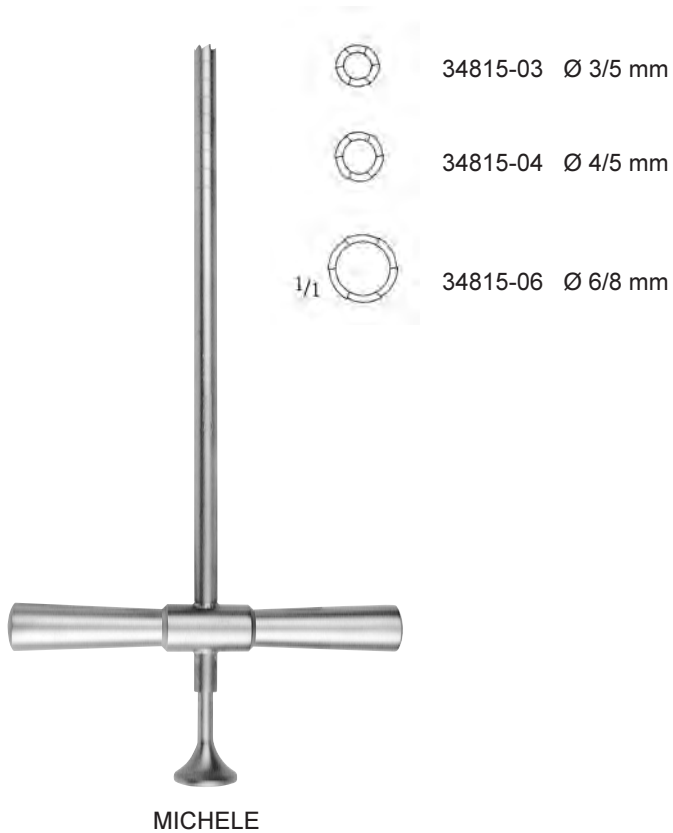

Reda Instrumente GmbH
Gänsäcker 34 - P.O. Box 131
D-78532 Tuttlingen

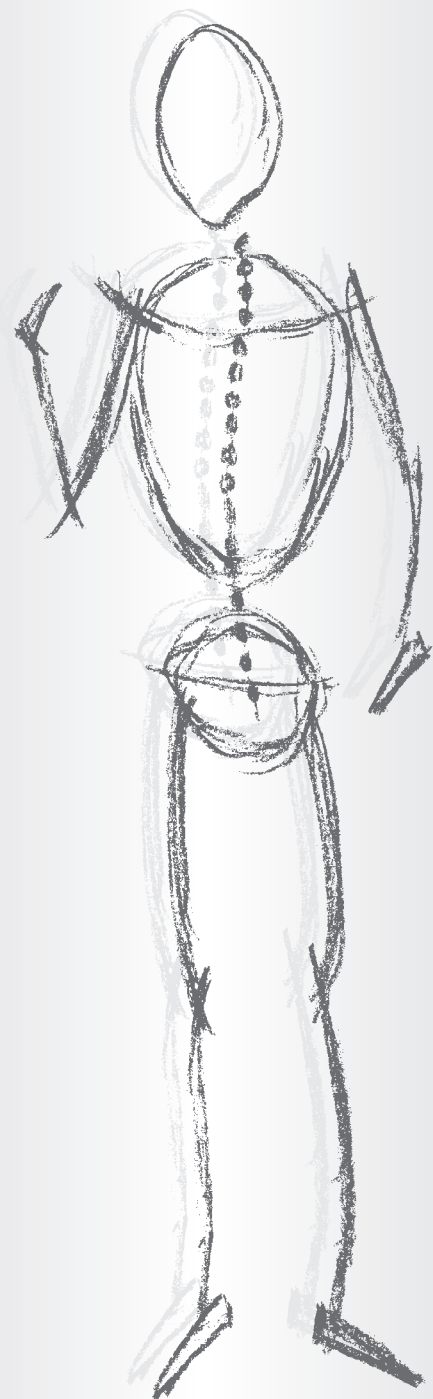

LÖFFEL, MEISSEL

CURETTES, CHISELS

CUCHARILLAS, CINCELES

CUCCHIAI, SCALPELLI

www.Reda-Instrumente.de

Scharfe Löffel
 Bone Currettes
 Cucharillas cortantes
 Curette taglianti

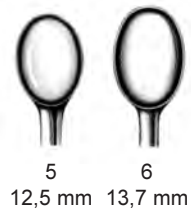
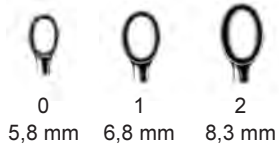

Fig.	
0000	33469-96
000	33469-97
00	33469-98
0	33470-00
1	33470-01
2	33470-02
3	33470-03
4	33470-04
5	33470-05
6	33470-06

VOLKMANN
 17 cm, 6 3/4"

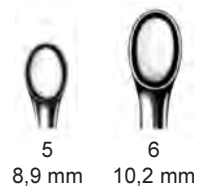
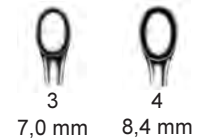
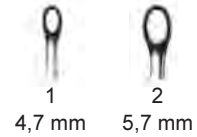
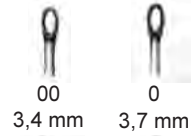
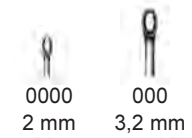

Fig.	
0000	33474-96
000	33474-97
00	33474-98
0	33475-00
1	33475-01
2	33475-02
3	33475-03
4	33475-04
5	33475-05
6	33475-06

SPRATT
 17 cm, 6 3/4"

Scharfe Löffel
Bone Currettes
Cucharillas cortantes
Curette taglienti



COBB
27,9 cm 11"

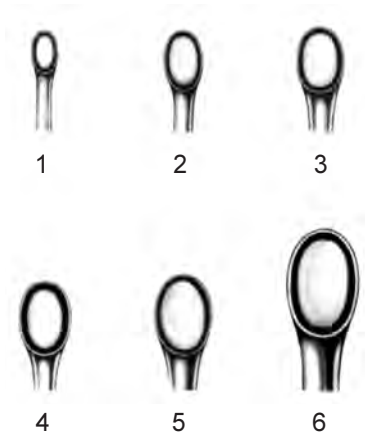

Fig.

1	33473-01	3,5 mm
2	33473-02	4,5 mm
3	33473-03	5,5 mm
4	33473-04	7,5 mm
5	33473-05	8,5 mm
6	33473-06	10,0 mm

Scharfe Löffel
 Bone Currettes
 Cucharillas cortantes
 Curette taglienti

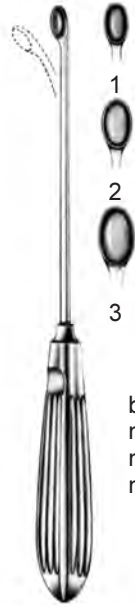

Fig.
 1 33476-01 4,8 mm
 2 33476-02 5,8 mm
 3 33476-03 6,8 mm

biegsam
 malleable
 maleable
 malleabile

HALLE
 21 cm, 8 1/4"



Fig.
 000 33476-98 2,8 mm
 00 33476-99 3,3 mm
 0 33477-00 3,7 mm
 1 33477-01 4,3 mm
 2 33477-02 4,8 mm
 3 33477-03 5,6 mm
 4 33477-04 6,1 mm
 5 33477-05 6,7 mm
 6 33477-06 8,8 mm

SPINAL
 20 cm, 8"

Scharfe Löffel
 Bone Curettes
 Cucharillas cortantes
 Curette taglienti

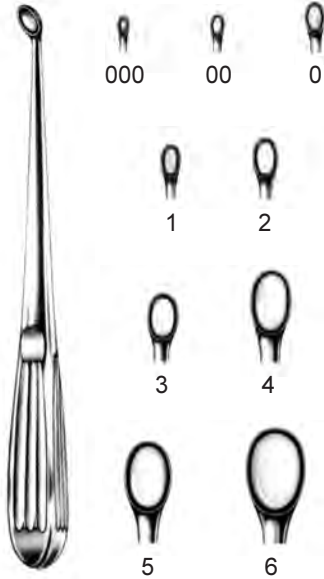

SPINAL
 20 cm, 8"

Fig.	Code	Size (mm)
000	33478-98	2,8 mm
00	33478-99	3,3 mm
0	33479-00	3,7 mm
1	33479-01	4,3 mm
2	33479-02	4,8 mm
3	33479-03	5,6 mm
4	33479-04	6,1 mm
5	33479-05	6,7 mm
6	33479-06	8,8 mm



SCOVILLE
 25 cm, 10"



33482-01 4,7 mm



33482-02 4,7 mm



33482-03 4,7 mm

Scharfe Löffel
 Bone Currettes
 Cucharillas cortantes
 Curette taglienti

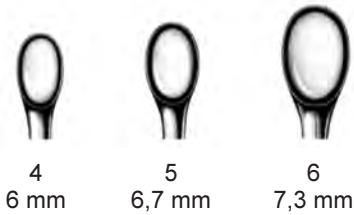
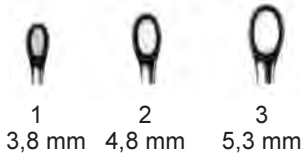
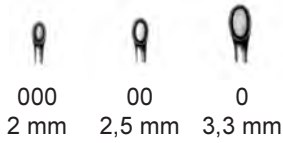

BRUNS
23 cm, 9"



BRUNS
23 cm, 9"



BRUNS
23 cm, 9"

Fig.

000	33480-97	33482-97	2,8 mm	33484-97	2,8 mm
00	33480-98	33482-98	3,3 mm	33484-98	3,3 mm
0	33481-00	33483-00	3,7 mm	33485-00	3,7 mm
1	33481-01	33483-01	4,3 mm	33485-01	4,3 mm
2	33481-02	33483-02	4,8 mm	33485-02	4,8 mm
3	33481-03	33483-03	5,6 mm	33485-03	5,6 mm
4	33481-04	33483-04	6,1 mm	33485-04	6,1 mm
5	33481-05	33483-05	6,7 mm	33485-05	6,7 mm
6	33481-06	33483-06	8,8 mm	33485-06	8,8 mm

Scharfe Löffel
 Bone Currettes
 Cucharillas cortantes
 Curette taglienti

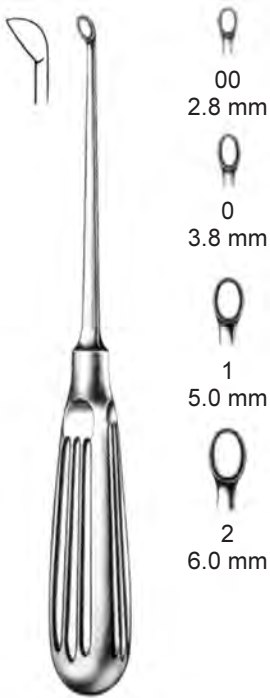

DAUBENSPECK
 20 cm, 8"

Fig.	00	33487-99
	0	33488-00
	1	33488-01
	2	33488-02

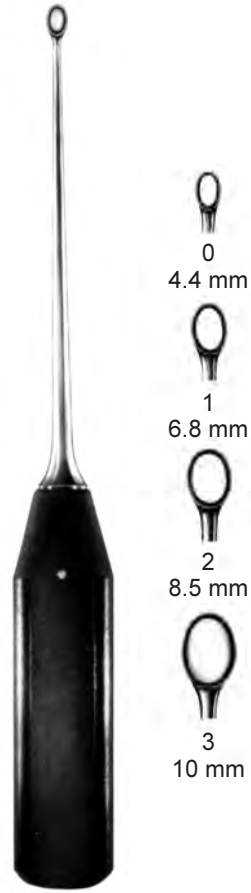

27 cm, 10 1/2"

Fig.	0	33489-00
	1	33489-01
	2	33489-02
	3	33489-03

Scharfe Löffel
 Bone Currettes
 Cucharillas cortantes
 Curette taglianti

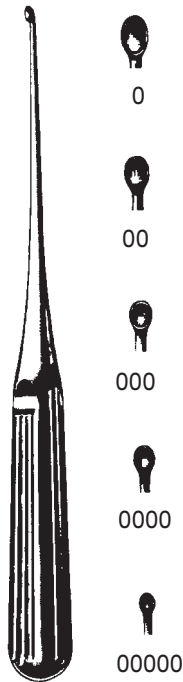

LEMPERT
 17,5 cm, 7"

Fig. 0	33490-10	3,3 mm
00	33490-20	3,0 mm
000	33490-30	2,7 mm
0000	33490-40	2,4 mm
00000	33490-50	2,0 mm

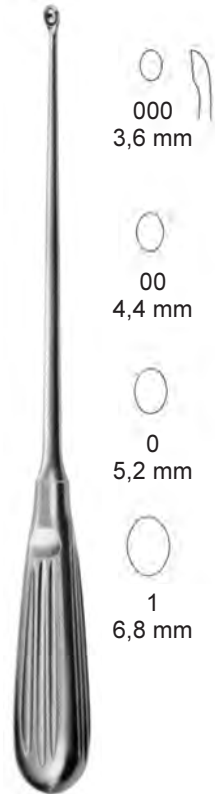

REDA
 25 cm, 10"

Fig. 000	33491-01
00	33491-02
0	33491-03
1	33491-04

Scharfe Löffel
Bone Curettes
Cucharillas cortantes
Curette taglienti

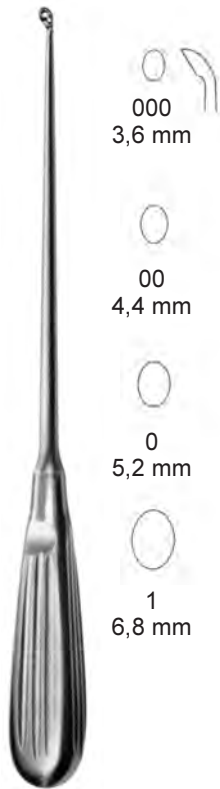

REDA
25 cm, 10"

Fig.	000	33491-05
	00	33491-06
	0	33491-07
	1	33491-08

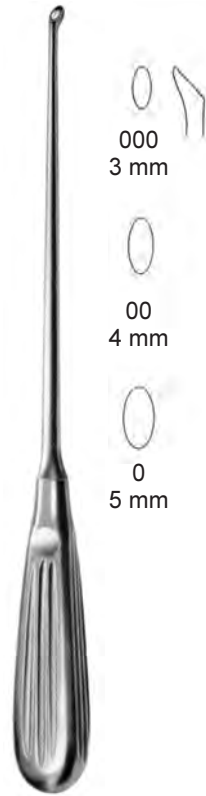

BUSHE
25 cm, 10"

Fig.	000	33500-01
	00	33500-02
	0	33500-03

Scharfe Löffel
 Bone Curettes
 Cucharillas cortantes
 Curette taglienti



33492-13	6.8 mm
33492-16	9.0 mm
33492-20	11.1 mm

33492-13	6.3 mm
33492-16	7.0 mm
33492-20	9.1 mm

VOLKMANN

33492-13	13 cm, 5 1/8"
33492-16	16 cm, 6 1/4"
33492-20	20 cm, 8"



33494-13	6.4 mm
33494-14	6.6 mm
33494-17	6.8 mm

33494-13	6.3 mm
33494-14	6.9 mm
33494-17	7.3 mm

VOLKMANN

33494-13	13 cm, 5 1/8"
33494-14	14 cm, 5 1/2"
33494-17	17 cm, 6 3/4"



5.2 mm

3.5 mm

JANSEN

33495-16	16 cm, 6 1/4"
----------	---------------

Mikro-Löffel
Micro Scoops
Micro-cucharillas
Micro curette



93430-01 230 mm / 9"
scharf
sharp
cortante
tagliante

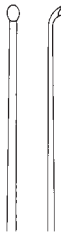

93430-02 230 mm / 9"
scharf
sharp
cortante
tagliante

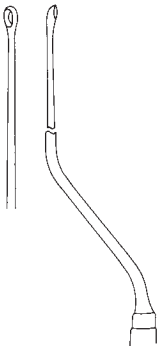

93430-03 185 mm / 7 1/4" YASARGIL
scharf
sharp
cortante
tagliante

Knochenspanhalter und Einsetzinstrument
Bone graft holder and impactor
Injerto óseo titular y impactador
Sostegno osseo e impattatore





CASPAR
33508-22
220 mm, 8 ³/₄"

Stößel
Hemostats
Hemostáticos
Pistoni





CASPAR
200 mm, 8"

-  33509-03
Ø 3 mm
-  33509-05
Ø 5 mm
-  33509-08
Ø 8 mm



200 mm, 8"

-  33510-12
Ø 12 mm
-  33510-14
Ø 14 mm
-  33510-16
Ø 16 mm

Flachmeißel, Osteotome, Hohlmeißel
 Chisels, Osteotomes, Gouges
 Cinceles, Osteotomos, Gubias
 Scalpelli, Osteotomi, sgorbie



STILLE
 20 cm, 8"



STILLE
 20 cm, 8"

6 mm	33630-06	
8 mm	33630-08	
10 mm	33630-10	33631-10
12 mm	33630-12	33631-12
15 mm	33630-15	33631-15
20 mm	33630-20	33631-20
25 mm	33630-25	33631-25
30 mm	33630-30	33631-30



STILLE
 20 cm, 8"



STILLE
 20 cm, 8"



STILLE
 20 cm, 8"

6 mm	33632-06	33633-06	33634-06
8 mm	33632-08	33633-08	33634-08
10 mm	33632-10	33633-10	33634-10
12 mm	33632-12	33633-12	33634-12
15 mm	33632-15	33633-15	33634-15
20 mm	33632-20	33633-20	33634-20
25 mm	33632-25	33633-25	33634-25
30 mm	33632-30	33633-30	33634-30

Osteotome, Hohlmeißel
 Osteotomes, Gouges
 Osteotomos, Gubias
 Osteotomi, sgorbie

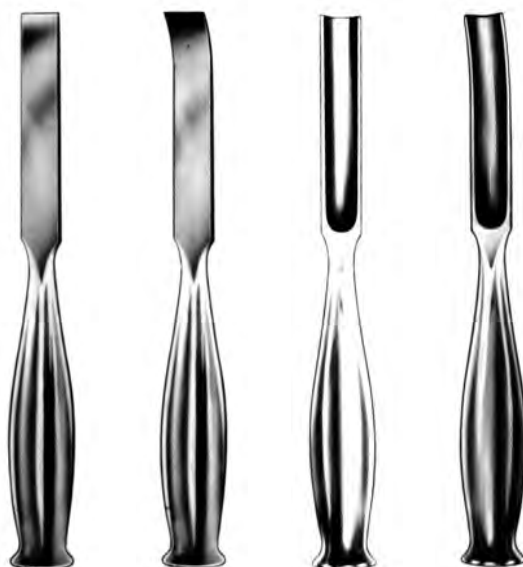

SMITH-PETERSEN
 20 cm, 8"

6 mm	33644-06	33645-06	33647-06	
9 mm	33644-09	33645-09	33647-09	33649-09
13 mm	33644-13	33645-13		
14 mm			33647-14	33649-14
16 mm	33644-16	33645-16	33647-16	33649-16
19 mm	33644-19	33645-19	33647-19	33649-19
25 mm	33644-25	33645-25	33647-25	33649-25
32 mm	33644-32	33645-32	33647-32	33649-32

Osteotome
 Osteotomes
 Osteotomos
 Osteotomi



LAMBOTTE

24 cm, 9 1/2"		23 cm, 9"
33650-04	4 mm	33651-04
33650-06	6 mm	33651-06
33650-08	8 mm	33651-08
33650-10	10 mm	33651-10
33650-13	13 mm	33651-13
33650-16	16 mm	33651-16
33650-18	18 mm	33651-18
33650-20	20 mm	33651-20
33650-25	25 mm	33651-25
33650-30	30 mm	33651-30
33650-38	38 mm	33651-38
33650-44	44 mm	33651-44
33650-50	50 mm	33651-50

Osteotome
 Osteotomes
 Osteotomos
 Mini Osteotomi

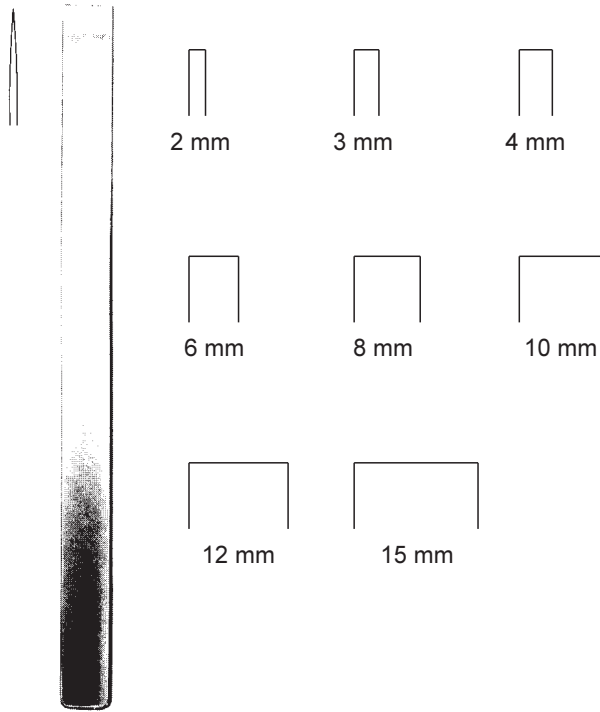

MINI-LAMBOTTE

	12,5 cm, 5"	17 cm, 6 3/4"
33654-02	2 mm	33652-02
33654-03	3 mm	33652-03
33654-04	4 mm	33652-04
33654-06	6 mm	33652-06
33654-08	8 mm	33652-08
33654-10	10 mm	33652-10
33654-12	12 mm	33652-12
33654-15	15 mm	33652-15

Hohlmeißel mit Ferrozellgriff
Gouges with Ferrozell-Handle
Gubias con mango de Ferrozell
Sgorbie con manico di Ferrozell

8 mm



COBB
28 cm, 11"
33656-28

8 mm



COBB
28 cm, 11"
33657-28

8 mm



COBB
28 cm, 11"
33658-28

8 mm



COBB
28 cm, 11"
33659-28

Osteotome, Hohlmeißel mit Ferrozell-Griff
 Osteotomes, Gouges with Ferrozell-Handle
 Osteotomos, Gubias con mango de Ferrozell
 Sgorbie, Osteotomo, con manico di Ferrozell

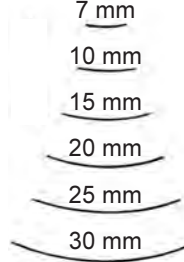
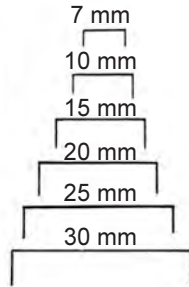

33660-07	7 mm	33661-07
33660-10	10 mm	33661-10
33660-15	15 mm	33661-15
33660-20	20 mm	33661-20
33660-25	25 mm	33661-25
33660-30	30 mm	33661-30

LEXER
 22 cm, 8 3/4"

LEXER
 22 cm, 8 3/4"

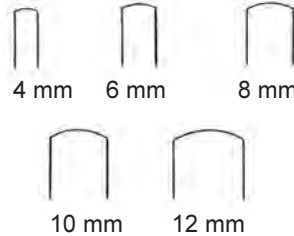
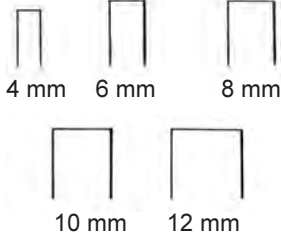

33664-04	4 mm	33665-04
33664-06	6 mm	33665-06
33664-08	8 mm	33665-08
33664-10	10 mm	33665-10
33664-12	12 mm	33665-12

LEXER MINI
 18 cm, 7"

LEXER MINI
 18 cm, 7"

Flachmeißel, Hohlmeißel
Chisels, Gouges
Cinceles, Gubias
Scalpelli, sgorbie



33665-24
24,5 cm, 9 ³/₄"

33665-26
26,5 cm, 10 ¹/₂"

ZIELKE
23 cm, 9"
33665-55 5,5 mm
33665-90 9,0 mm

33666-22
22 cm, 8 ³/₄"

Meißel
Gouges
Gubias
Sgorbie

Wirbelsäulenmeißel
Lamina gouge
Gubias para la columna vertebral
Sgorbie per la colonna vertebrale



23,5 cm, 9 1/4"

33667-06	6 mm
33667-08	8 mm
33667-11	11 mm
33667-16	16 mm

Hohlmeißel mit NOVOTEX-Griff
Gouges with NOVOTEX-Handle
Gubias con mango de NOVOTEX
Sgorbie con manico di NOVOTEX



— 25 cm, 10" —

33669-05	5 mm	33670-05
33669-10	10 mm	33670-10
33669-15	15 mm	33670-15

Septum Osteotom
Rhinoplastic Osteotome
Osteotomos para la plástica nasal
Osteotomo per plastica nasale

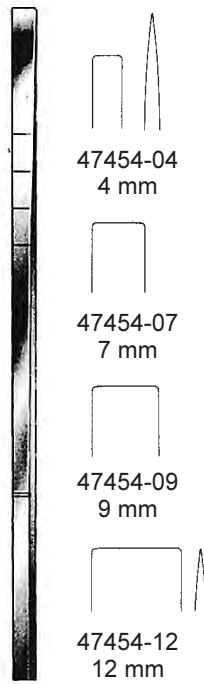

COTTLE
18 cm, 7"

Reda Instrumente GmbH
Gänsäcker 34 - P.O. Box 131
D-78532 Tuttlingen



**ELEVATORIEN
RASPATORIEN
DISSEKTOREN**

**ELEVATORS
RASPATORIES
DISSECTORS**

**ELEVADORES
PERIOSTÓTOMOS
DISECTORES**

**ELEVATORI
PERIOSTOTOMI
DISSETTORI**



www.Reda-Instrumente.de

Elevatorien, Raspatorien, Dissektoren
Elevators, Raspatories, Dissectors
Elevadores, Periostótomos, Disectores
Elevatori, Periostotomi, Dissettori

15 mm



JANSEN
33701-16
16,5 cm, 6 1/2"

12,5 mm



FARABEUF
33702-15
15 cm, 5.9"

12,5 mm



FARABEUF
33703-15
15 cm, 5.9"

11 mm

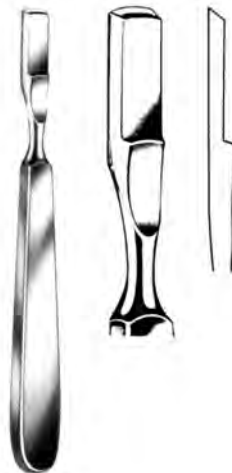

FARABEUF-COLLIN
33704-01
15,5 cm, 6"

Elevatorien, Raspatorien, Dissektoren
Elevators, Raspatories, Dissectors
Elevadores, Periostótomos, Disectores
Elevatori, Periostotomi, Dissettori

11 mm

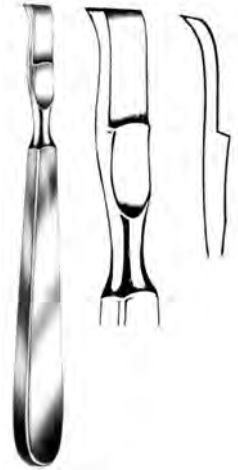

FARABEUF-COLLIN
33704-02
15,5 cm, 6"



LAMBOTTE
21 cm, 8 1/4"
33705-05 5 mm
33705-10 10 mm
33705-15 15 mm
33705-20 20 mm
33705-25 25 mm

18 mm



SEDILLOT
33706-18
18 cm, 7"

6 mm



CUSHING
(LITTLE-JOKER)
33707-15
15 cm, 5.9"

Elevatoriën, Raspatoriën, Dissektoren
Elevators, Raspatories, Dissectors
Elevadores, Periostótomos, Disectores
Elevatori, Periostotomi, Dissettori

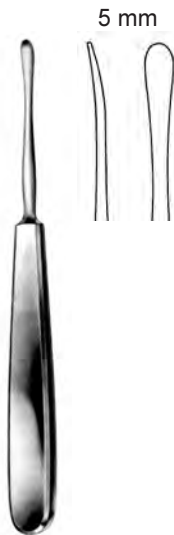

SEBILLEAU
33707-17
17,5 cm, 7"



QUERVAIN
33708-19
19,5 cm, 7 3/4"

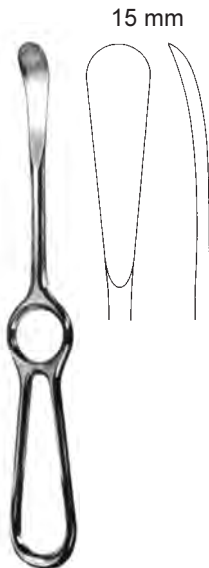

SEDILLOT
33709-21
21 cm, 8 1/4"

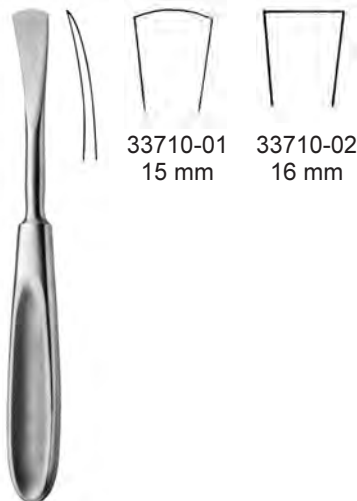

CUSHING
18 cm, 7"

Elevatorien, Raspatorien, Dissektoren
Elevators, Raspatories, Dissectors
Elevadores, Periostótomos, Disectores
Elevatori, Periostotomi, Dissettori

halbscharf
semi-sharp
semi agudo
semiacuto



HOEN
18 cm, 7"

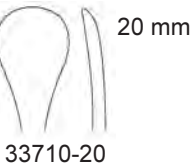
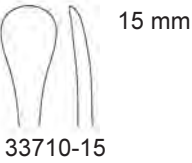
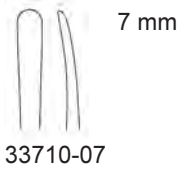

16 mm



LANGENBECK
33710-19
19 cm, 7 1/2"

14 mm



LANGENBECK
33711-18
18 cm, 7"



LANGENBECK
20 cm, 8"
33711-20 8 mm
33711-21 10 mm

Elevatorien, Raspatorien, Dissektoren
 Elevators, Raspatories, Dissectors
 Elevadores, Periostótomos, Disectores
 Elevatori, Periostotomi, Dissettori

4 mm



WILLIGER
 33711-16
 16 cm, 6 1/4"

6,5 mm



WILLIGER
 33712-16
 16 cm, 6 1/4"

5 mm



WILLIGER
 33713-16
 16 cm, 6 1/4"

5,5 mm



WILLIGER
 33713-17
 17 cm, 6 3/4"

5 mm

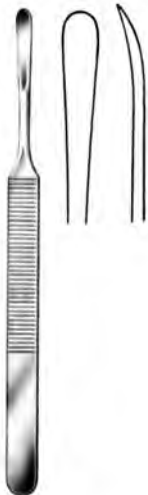

KÖNIG
 33714-15
 15,5 cm, 6"

12 mm

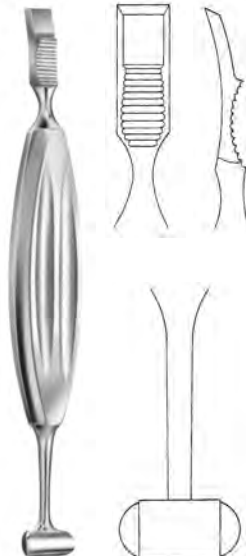

ALEXANDER
 33715-20
 21 cm, 8 1/4"



MOLT
 33716-18
 18 cm, 7"

Elevatorien, Raspatorien, Dissektoren
 Elevators, Raspatories, Dissectors
 Elevadores, Periostótomos, Disectores
 Elevatori, Periostotomi, Dissettori

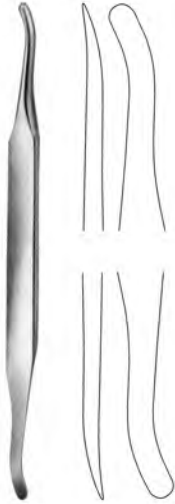

SELDIN
 33717-19-01
 19,5 cm, 7 3/4"

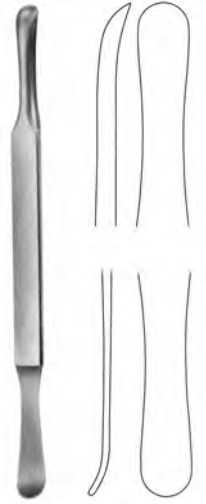

SELDIN
 33717-19-02
 19,5 cm, 7 3/4"

4 mm



JOSEPH
 33718-16
 16 cm, 6 1/4"

4 mm



FOMON
 33719-17
 17 cm, 6 3/4"

9 mm



BOIES
 33720-19
 19 cm, 7 1/2"



GORNEY
 33720-21
 21 cm, 8 1/4"

Elevatorien, Raspatorien, Dissektoren
Elevators, Raspatories, Dissectors
Elevadores, Periostótomos, Disectores
Elevatori, Periostotomi, Dissettori

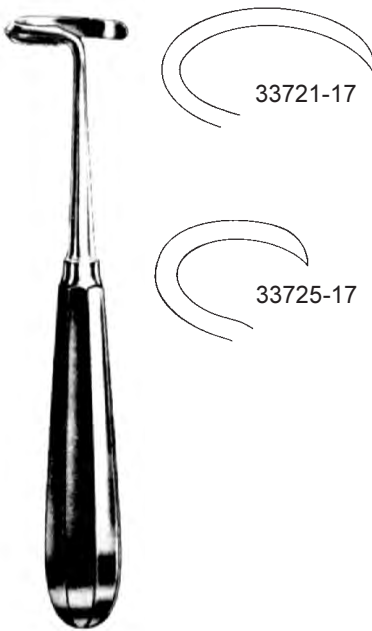

DOYEN
17 cm, 6 ³/₄"

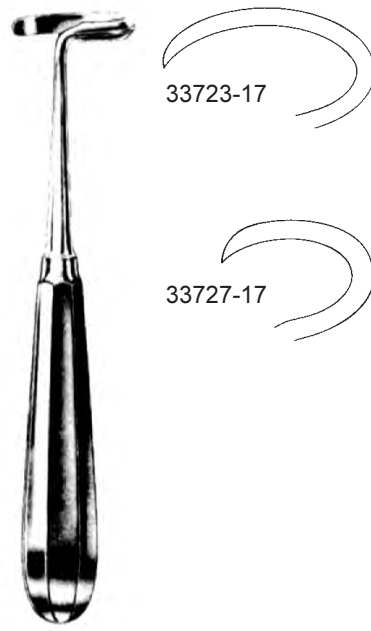

DOYEN
17 cm, 6 ³/₄"

Elevatorien, Raspatorien, Dissektoren
Elevators, Raspatories, Dissectors
Elevadores, Periostótomos, Disectores
Elevatori, Periostotomi, Dissettori



17 cm, 6 ³/₄"

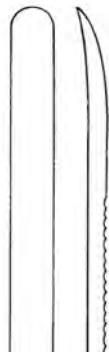

33722-06
6 mm

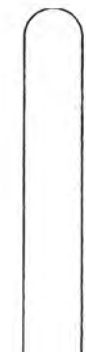

33722-08
8 mm

Hohlheft
hollow handle
mango hueco
manico vuoto



33728-24



33729-24



DOYEN
24 cm, 9 ¹/₂"

Elevatoren, Raspatorien, Dissektoren
Elevators, Raspatories, Dissectors
Elevadores, Periostótomos, Disectores
Elevatori, Periostotomi, Dissettori



MATSON-ALEXANDER
33731-22
22 cm, 8 ³/₄"



MATSON
33733-22
22 cm, 8 ³/₄"

Elevatoren, Raspatorien, Dissektoren
Elevators, Raspatories, Dissectors
Elevadores, Periostótomos, Disectores
Elevatori, Periostotomi, Dissettori



33740-19
19 cm, 7 1/2"



33741-18
18,5 cm, 7 1/4"



33742-18
18,5 cm, 7 1/4"



33743-18
18,5 cm, 7 1/4"

Elevatorii, Raspatorii, Disektoren
Elevators, Raspatories, Dissectors
Elevadores, Periostótomos, Disectores
Elevatori, Periostotomi, Dissettori

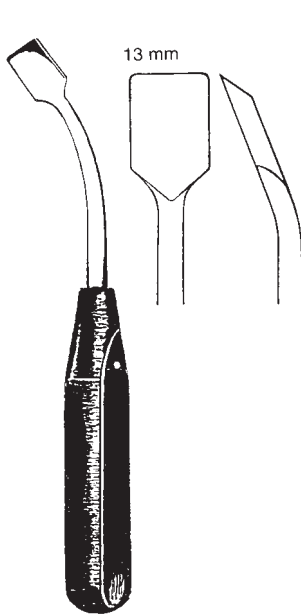

33745-19
18,5 cm, 7 1/4"

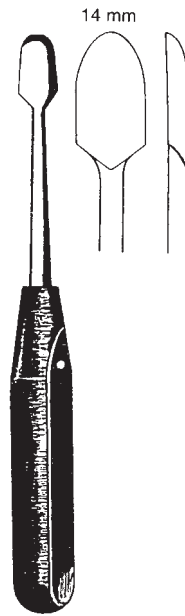

33746-19
19,5 cm, 7 3/4"

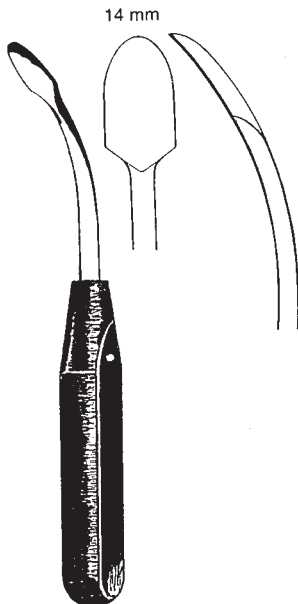

33747-18
18,5 cm, 7 1/4"

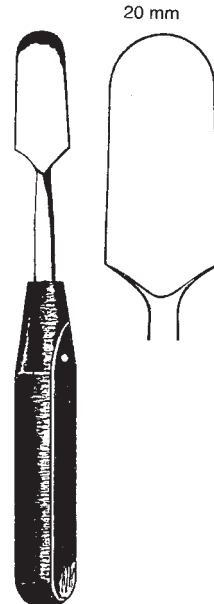

33748-20
20 cm, 8"

Elevatorien, Raspatorien, Dissektoren
 Elevators, Raspatories, Dissectors
 Elevadores, Periostótomos, Disectores
 Elevatori, Periostotomi, Dissettori

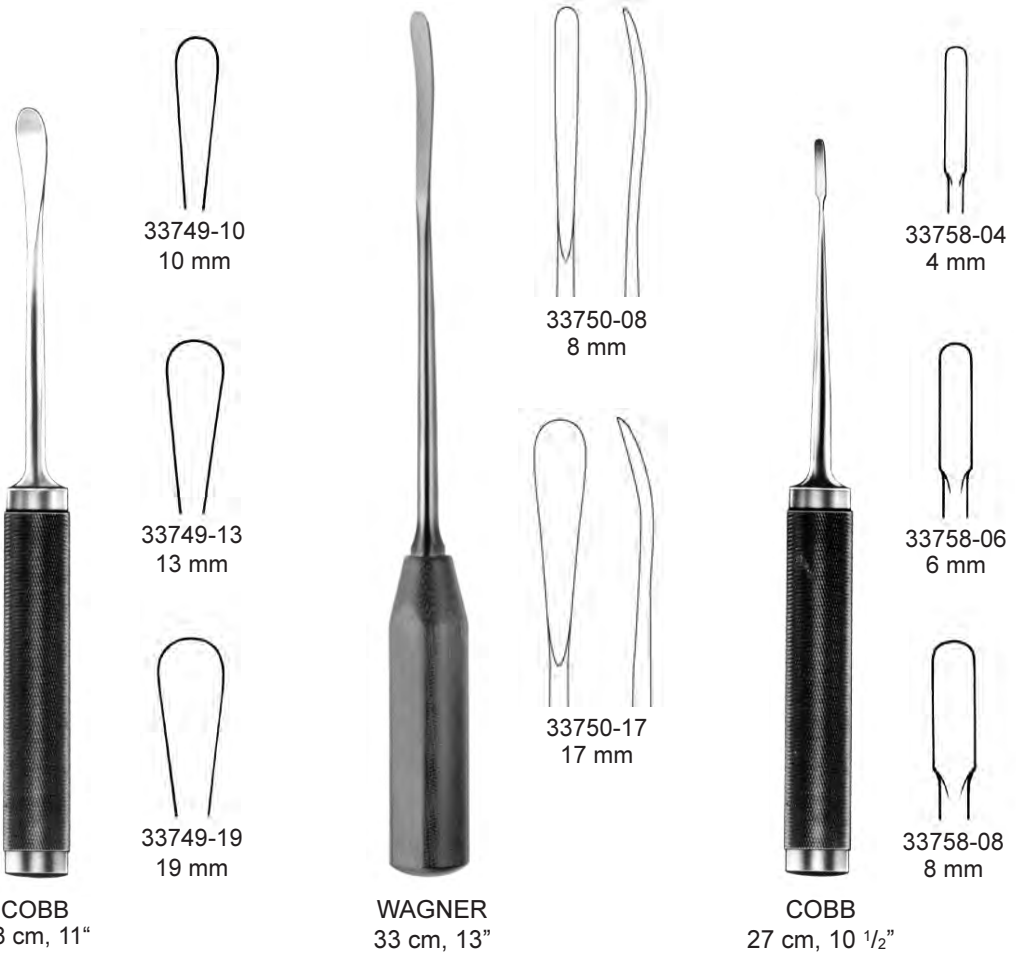

mit NOVOTEX-Kunststoffgriff
 with NOVOTEX plastic handle
 con mango de materia plástica NOVOTEX
 con manico di materia plastica NOVOTEX

Elevatorien, Raspatorien, Dissektoren
 Elevators, Raspatories, Dissectors
 Elevadores, Periostótomos, Disectores
 Elevatori, Periostotomi, Dissettori



ADSON
 17 cm, 6 ³/₄"

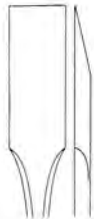

33754-17



33755-17



33756-17



33757-17



KEY
 33759-06 - 33759-25
 19 cm, 7 ¹/₂"

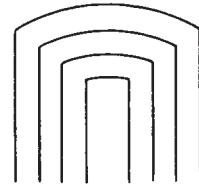

33759-06	6 mm
33759-12	12 mm
33759-19	19 mm
33759-25	25 mm

Elevatoren, Raspatorien, Dissektoren
Elevators, Raspatories, Dissectors
Elevadores, Periostótomos, Disectores
Elevatori, Periostotomi, Dissettori

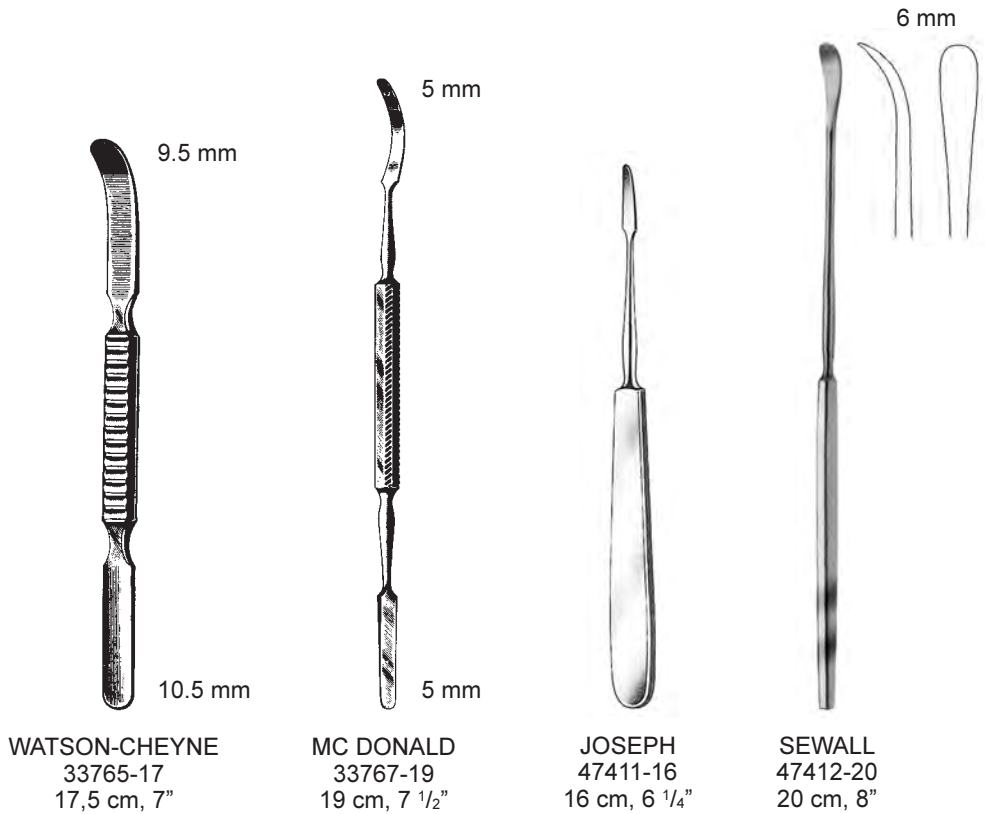

Elevatorien, Raspatorien, Dissektoren
Elevators, Raspatories, Dissectors
Elevadores, Periostótomos, Disectores
Elevatori, Periostotomi, Dissettori



ROGER
47413-19
19 cm, 7 1/2"



FREER
47415-18
18 cm, 7"

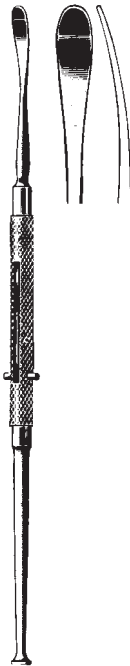

FREER
47417-19
19 cm, 7 1/2"

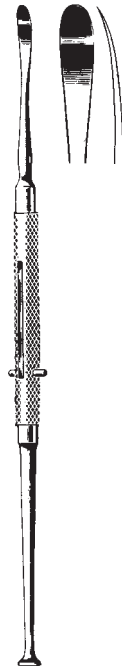

FREER
47419-19
19 cm, 7 1/2"

Dura Dissektoren
Dura Dissectors
Disectores para duramadre
Dissettori per dura-madre



SACHS
41143-21
21 cm, 8 1/4"

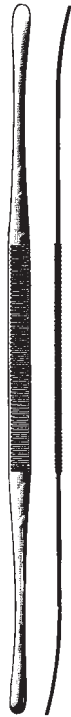

TOENNIS
41141-25
25 cm, 10"

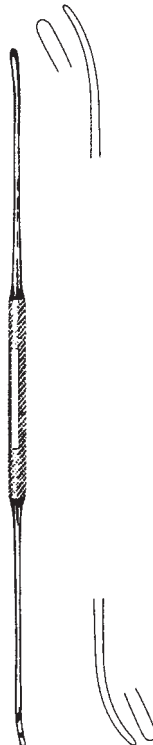

OLIVECRONA
41146-18 18 cm, 7"
41146-24 24 cm, 9 1/2"



DAVIS
41142-19
19 cm, 7 1/2"

Dura Dissektoren
Dura Dissectors
Disectores para duramadre
Dissettori per dura-madre

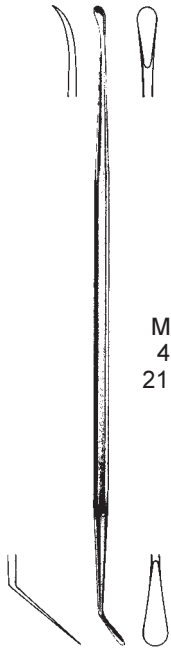

MILLIGAN
41147-21
21 cm, 8 1/4"



41149-22
22 cm, 8 3/4"

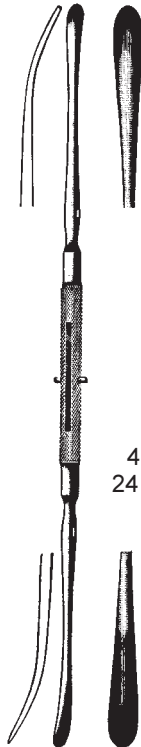

DAVIS
41151-24
24 cm, 9 1/2"

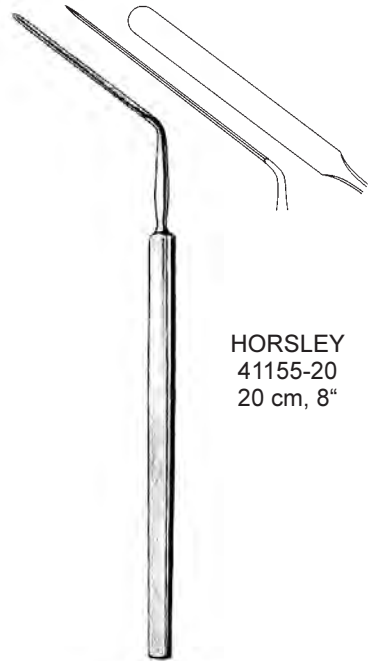

HORSLEY
41155-20
20 cm, 8"

Dura Dissektoren
Dura Dissectors
Disectores para duramadre
Dissettori per dura-madre



WOODSON
41156-18
18 cm, 7"

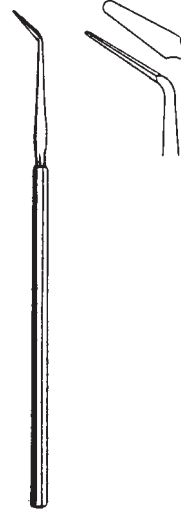

FRAZIER
41158-01
15 cm, 6"

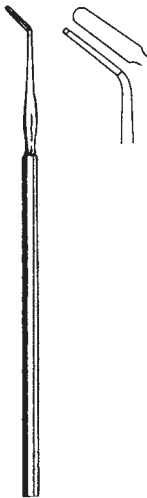

HOEN
41158-02
15 cm, 6"

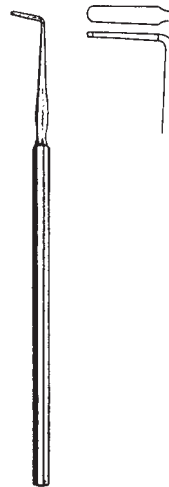

HOEN
41158-03
15 cm, 6"

Dissektoren, doppelendig
Dissectors, double ended
Disectores, de doble extremo
Dissettori, doppio

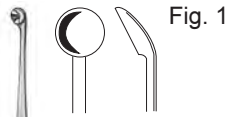

PENFIELD
41161-01
175 mm, 7"

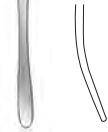

Fig. 2



PENFIELD
41161-02
195 mm, 7 3/4"



Fig. 3



PENFIELD
41161-03
195 mm, 7 3/4"



Fig. 4



PENFIELD
41161-04
205 mm, 8"



Fig. 5



PENFIELD
41161-05
290 mm, 11 1/2"



Mikro-Raspatorien
Micro-Raspatories
Legras para micro-cirugía
Micro periostotomi



93410-01 185 mm / 7 1/4" YASARGIL

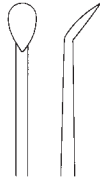

93410-02 185 mm / 7 1/4" YASARGIL



93410-03 185 mm / 7 1/4" YASARGIL

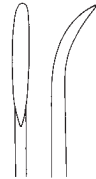

93410-05 185 mm / 7 1/4" YASARGIL



93410-06 230 mm / 9"
plattenförmig
round blade
redondo
rotondo piatto



93410-07 230 mm / 9"
plattenförmig
round blade
redondo
rotondo piatto

Mikro-Raspatorien
Micro-Raspatories
Legras para micro-cirugía
Micro periostotomi

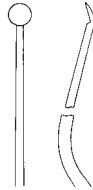

93420-01 230 mm / 9"

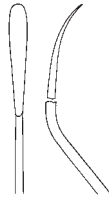

93420-02 185 mm / 7 1/4" YASARGIL

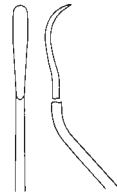

93420-03 185 mm / 7 1/4" YASARGIL

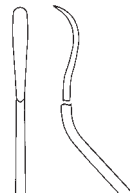

93420-04 185 mm / 7 1/4" YASARGIL

Mikro-Dissektoren
Micro Dissectors
Micro dissectores
Micro scollatori



4,5 mm



CASPAR
93480-23
230 mm / 9"

1,0 mm



CASPAR
93481-20
200 mm / 8"

1,4 mm



93482-23
230 mm / 9"

2,0 mm



93483-23
230 mm / 9"

1,8 mm



93484-23
230 mm / 9"

3,0 mm



93485-18
185 mm / 7 1/4"

3,0 mm









93486-21
215 mm / 8 1/2"

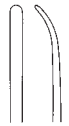

YASARGIL
93487-18
185 mm / 7 1/4"

Mikro-Dissektoren
Micro Dissectors
Micro disectores
Micro scollatori

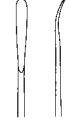

 4,5 mm	93490-01	230 mm / 9"	CASPAR
 2 mm	93490-02	230 mm / 9"	CASPAR
 1 mm	93490-03	210 mm / 8 1/4"	CASPAR
 1 mm	93490-04	210 mm / 8 1/4"	CASPAR
 1,8 mm	93490-05	230 mm / 9"	
 1,8 mm	93490-06	230 mm / 9"	

Reda Instrumente GmbH
Gänsäcker 34 - P.O. Box 131
D-78532 Tuttlingen

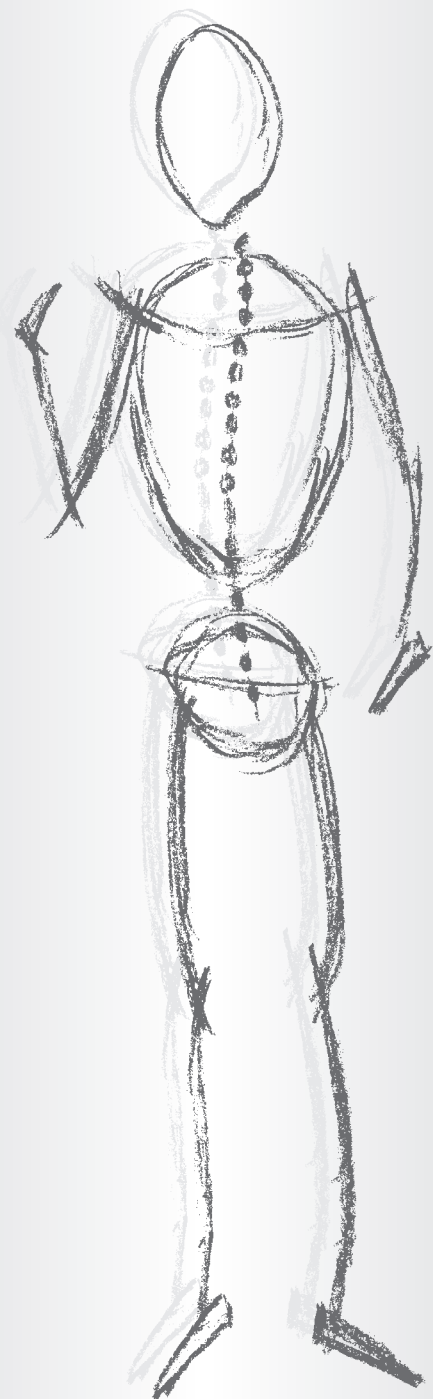

SAUGROHRE

SUCTION TUBES

TUBOS DE ASPIRACIÓN

TUBI D'ASPIRAZIONE



www.Reda-Instrumente.de

Saugrohre
Suction Tubes
Tubos de aspiración
Tubi aspirazioni



ADSON
41290-21
21 cm, 8 1/4"
ø 4 mm



FERGUSON
41294-40
18 cm, 7"
ø 4 mm, 90°

isoliert
insolated
aislado
isolato

Saugrohre, Punktionskanüle
 Suction Tubes, Puncture Cannulas
 Tubos de aspiración, Tubo de punción
 Tubi aspirazioni, cannula per punzione

Charr.	↗	
F.G. 30°		75°
6	41295-06	41297-06
7	41295-07	41297-07
8	41295-08	41297-08
9	41295-09	41297-09
10	41295-10	41297-10
11	41295-11	41297-11
12	41295-12	41297-12
15	41295-15	

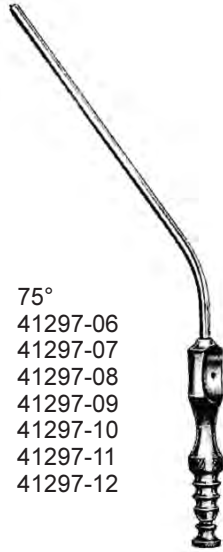

FRAZIER/FERGUSSON
 41295-06 – 41297-12
 19 cm, 7 1/2"



FRAZIER/FERGUSSON
 41298-12
 12 cm, 4 3/4" / 3 mm

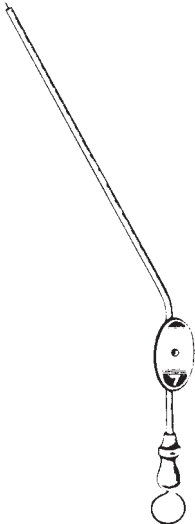

BARON
 16 cm, 6 1/4"
 41299-03 3FR 1,0 mm
 41299-05 5FR 1,6 mm
 41299-07 7FR 2,3 mm



SCHUHKNECHT
 13 cm, 5"
 41300-09 Ø 0,9 mm / 20 swg
 41300-06 Ø 0,6 mm / 24 swg

Saugadapter
 mit Saugunterbrecher
 Suction adapter
 with finger cut-off
 Adaptador para
 aspiración con interrupto
 Adattator per
 aspirazione con interruttore



HOUSE
 41300-00
 5,5 cm, 2 1/4"

Saugrohre
Suction Tubes
Tubos de aspiración
Tubi aspirazioni

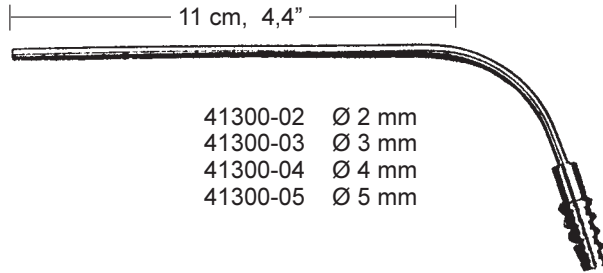

- 41300-02 Ø 2 mm
- 41300-03 Ø 3 mm
- 41300-04 Ø 4 mm
- 41300-05 Ø 5 mm

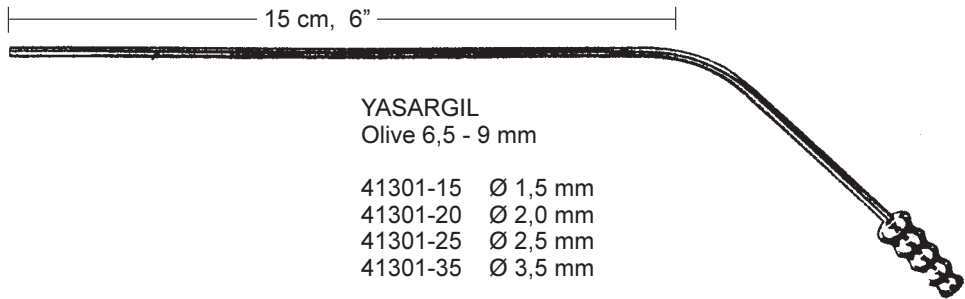

YASARGIL
Olive 6,5 - 9 mm

- 41301-15 Ø 1,5 mm
- 41301-20 Ø 2,0 mm
- 41301-25 Ø 2,5 mm
- 41301-35 Ø 3,5 mm



ZÖLLNER
41302-01



ZÖLLNER
41302-02



- 0,5 mm Ø 41306-05
- 0,7 mm Ø 41306-07
- 0,9 mm Ø 41306-09
- 1,2 mm Ø 41306-12

Kanüle für Sauggriff
für Zöllner und Wullstein

Tip for Suction Handle
for Zöllner and Wullstein

Cánula para mango
para Zöllner y Wullstein

Cannula per manico di aspirazione
per Zöllner e Wullstein

Saugrohre
Suction Tubes
Tubos de aspiración
Tubi aspirazioni

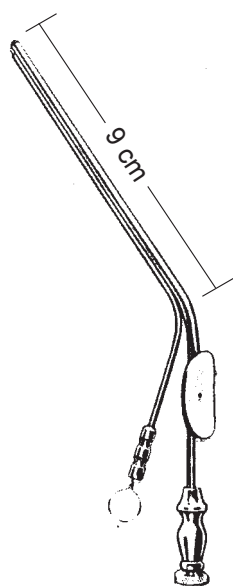

HOUSE

9 cm, 3 1/2"

41303-09	Ø 0,9 x 0,7 mm
41303-12	Ø 1,2 x 0,9 mm
41303-15	Ø 1,5 x 1,2 mm
41303-18	Ø 1,8 x 1,8 mm
41303-25	Ø 2,5 x 2,0 mm
41303-30	Ø 3,0 x 2,0 mm
41303-45	Ø 4,5 x 2,0 mm



PLESTER 30°

Charr. 6	41304-06
Charr. 8	41304-08
Charr. 10	41304-10

Saugrohre
Suction Tubes
Tubos de aspiración
Tubi aspirazioni

Mikro-Saugkanüle
Micro suction cannula
Micro tubo de aspiración
Micro-cannula d'aspirazione

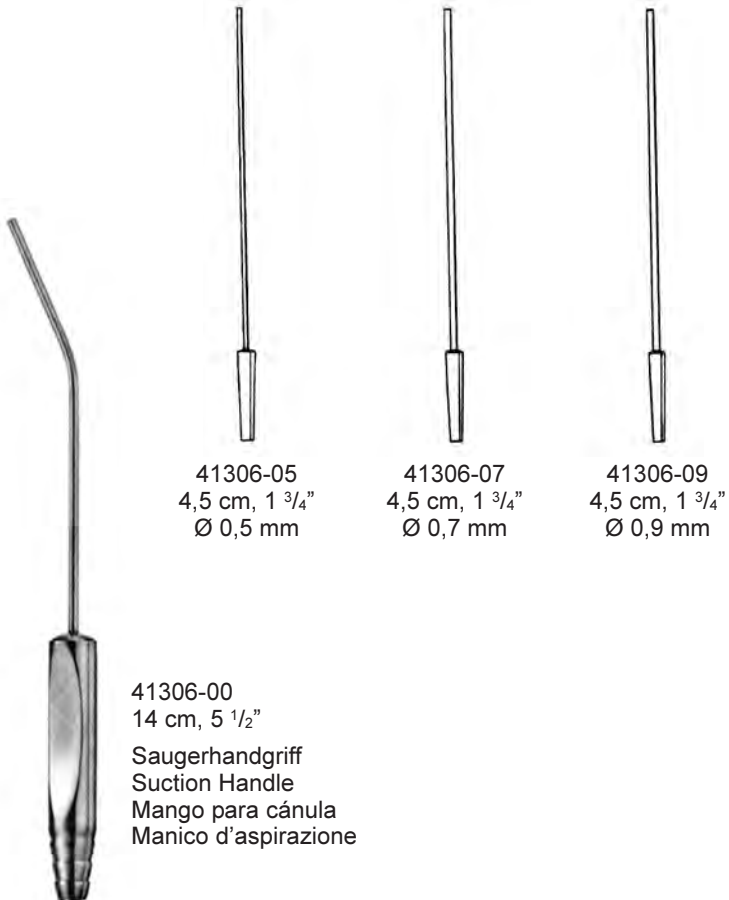

41306-05
4,5 cm, 1 ³/₄"
Ø 0,5 mm

41306-07
4,5 cm, 1 ³/₄"
Ø 0,7 mm

41306-09
4,5 cm, 1 ³/₄"
Ø 0,9 mm

41306-00
14 cm, 5 ¹/₂"
Saugerhandgriff
Suction Handle
Mango para cánula
Manico d'aspirazione

WULLSTEIN
41308-00

komplett, mit Griff und drei Aufsätzen
complete, with handle and 3 tips
completo, con mango y 3 puntas
completo, con manico e 3 punte

Saugraspatorium
Suction Raspatory
Legra de succión
Raspatorio con aspiratore



GULEN
47347-20
19 cm, 7 1/2"

Reda Instrumente GmbH
Gänsäcker 34 - P.O. Box 131
D-78532 Tuttlingen



LAMINEKTOMIE

LAMINECTOMY

LAMINECTOMIA

LAMINECTOMIA



www.Reda-Instrumente.de

Laminektomie Zangen
 Laminectomy Forceps
 Pinzas para laminectomia
 Pinze per laminectomia

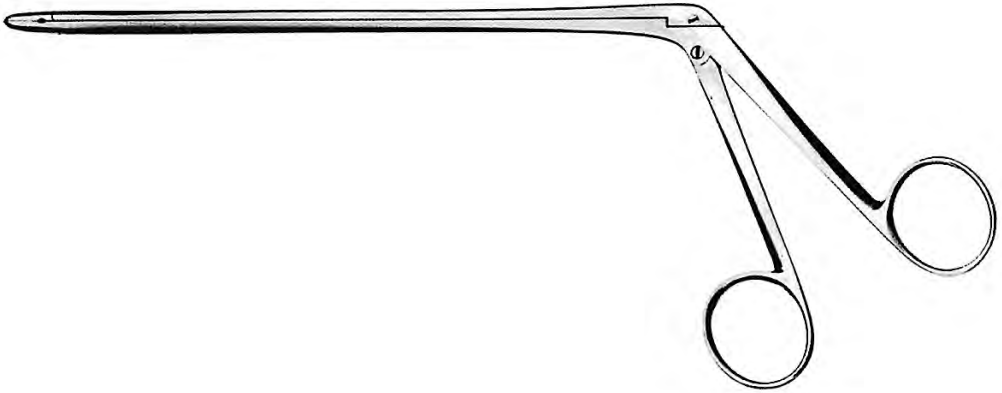



 CUSHING
 2 x 10 mm

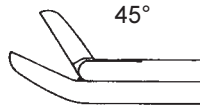

41420-01
 41421-01
 41422-01

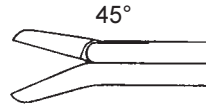

41420-02
 41421-02
 41422-02



41420-03 125 mm / 5"
 41421-03 150 mm / 6"
 41422-03 180 mm / 7"

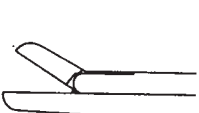

 LOVE-GRUENWALD
 3 x 10 mm

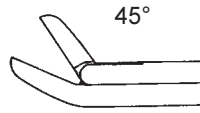

41430-01
 41431-01
 41432-01

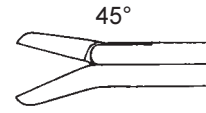

41430-02
 41431-02
 41432-02



41430-03 125 mm / 5"
 41431-03 150 mm / 6"
 41432-03 180 mm / 7"

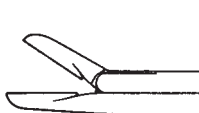

 SPURLING
 4 x 10 mm



41440-01
 41441-01
 41442-01

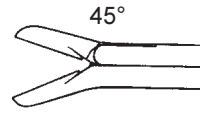

41440-02
 41441-02
 41442-02



41440-03 125 mm / 5"
 41441-03 150 mm / 6"
 41442-03 180 mm / 7"

Laminektomie Zangen
Laminectomy Forceps
Pinzas para laminectomia
Pinze per laminectomia

15 cm, 6"

-  41448-02 2 x 10 mm
-  41448-03 3 x 10 mm
-  41448-04 4 x 10 mm

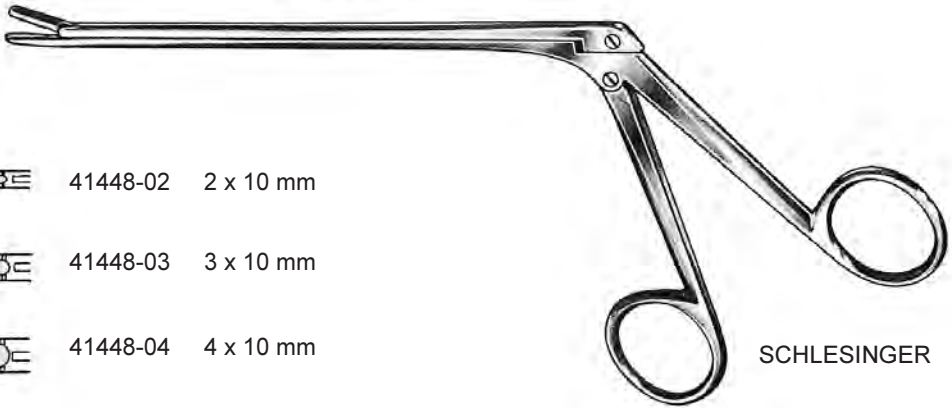

15 cm, 6"

3 x 10 mm



41449-01

41449-02

41449-03

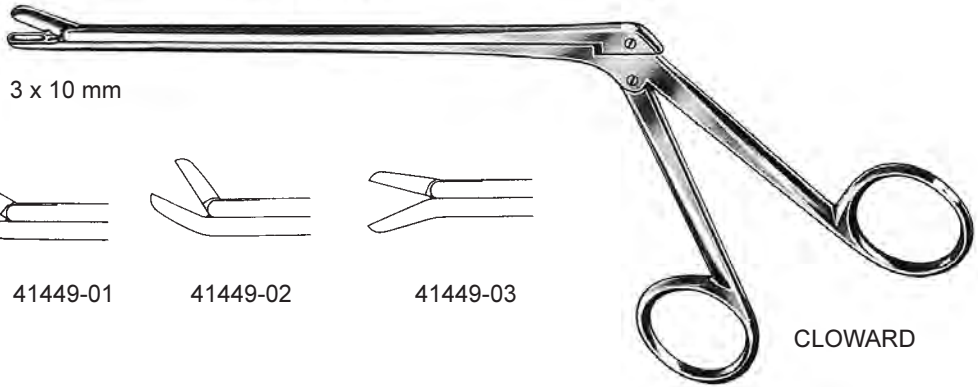

Laminektomie Zangen
Laminectomy Forceps
Pinzas para laminectomia
Pinze per laminectomia

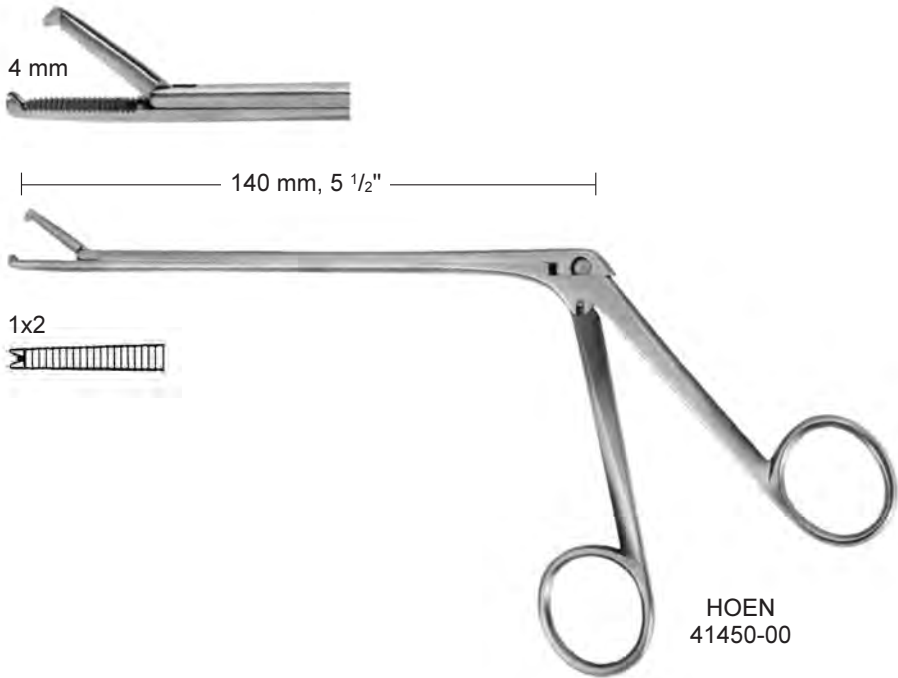

Laminektomie Zangen
Laminectomy Forceps
Pinzas para laminectomia
Pinze per laminectomia

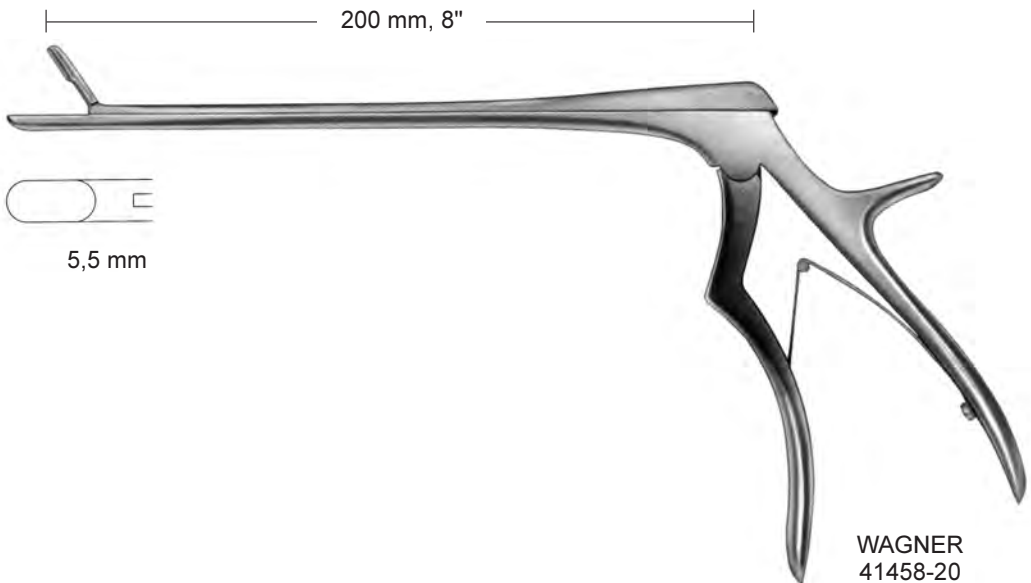
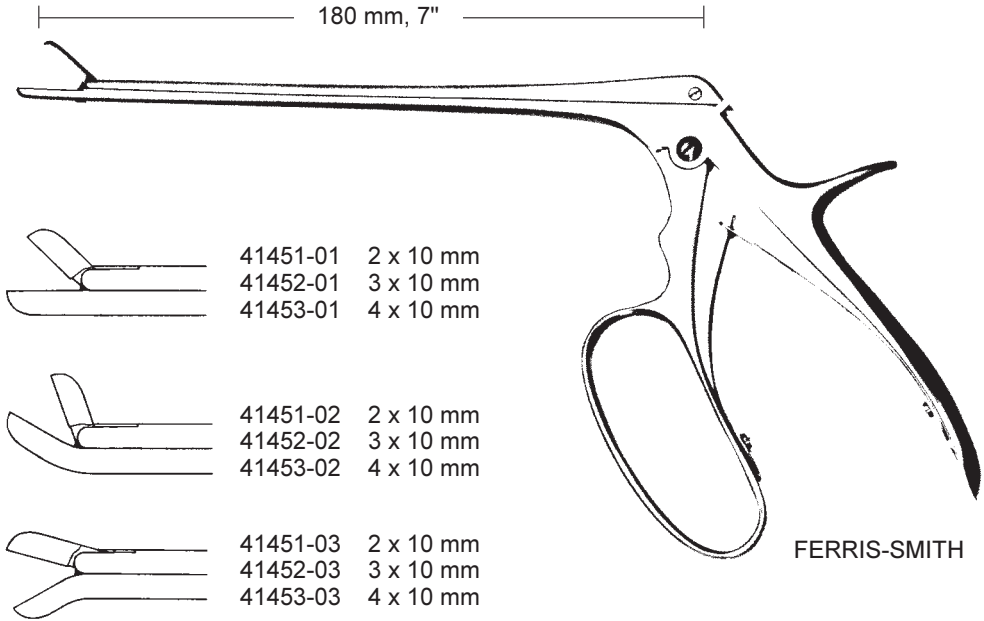

Laminektomie Zangen
 Laminectomy Forceps
 Pinzas para laminectomia
 Pinze per laminectomia



Maulteile gezahnt
 Serrated jaws
 Parte de la boca dentada
 Morsi dentellati

CASPAR

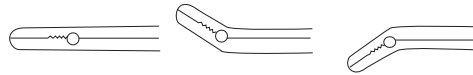

	41460-01	41460-02	41460-03	140 mm / 5 1/2"
2 x 12 mm	41461-01	41461-02	41461-03	160 mm / 6 1/4"
	41462-01	41462-02	41462-03	185 mm / 7 1/4"
	41465-01	41465-02	41465-03	140 mm / 5 1/2"
3 x 12 mm	41466-01	41466-02	41466-03	160 mm / 6 1/4"
	41467-01	41467-02	41467-03	185 mm / 7 1/4"
	41470-01	41470-02	41470-03	140 mm / 5 1/2"
4 x 14 mm	41471-01	41471-02	41471-03	160 mm / 6 1/4"
	41472-01	41472-02	41472-03	185 mm / 7 1/4"
	41475-01	41475-02	41475-03	140 mm / 5 1/2"
5 x 14 mm	41476-01	41476-02	41476-03	160 mm / 6 1/4"
	41477-01	41477-02	41477-03	185 mm / 7 1/4"
	41480-01	41480-02	41480-03	140 mm / 5 1/2"
6 x 16 mm	41481-01	41481-02	41481-03	160 mm / 6 1/4"
	41482-01	41482-02	41482-03	185 mm / 7 1/4"

Laminektomie Zangen
Laminectomy Forceps
Pinzas para laminectomia
Pinze per laminectomia



 2 mm	41490-01	41490-02	41490-03
 3 mm	41492-01	41492-02	41492-03
 4 mm	41494-01	41494-02	41494-03
 5 mm	41496-01	41496-02	41496-03

Laminektomie Zangen
 Laminectomy Forceps
 Pinzas para laminectomia
 Pinze per laminectomia

120 mm, 4 3/4"

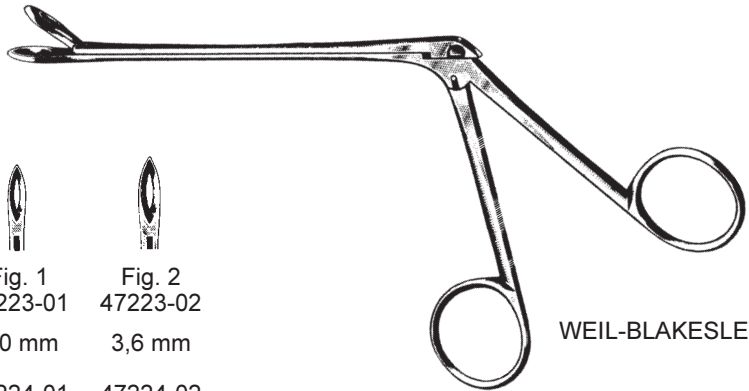

WEIL-BLAKESLEY



Fig. 1
47223-01

3,0 mm



47224-01



Fig. 2
47223-02

3,6 mm

47224-02



Fig. 3
47223-03

4,2 mm



47224-03



Fig. 4
47223-04

4,8 mm

47224-04



Fig. 5
47223-05

5,8 mm

47224-05

Hypophysen- und Tumorzangen
Pituitary Rongeurs and Tumor Grasping Forceps
Pinzas cortantes para hipófisis y para tumores
Pinze per ipofisi e tumori



ø 7 mm

41445-25

180 mm / 7"

OLDBERG

Scharfe Hypophysenzange
Sharp Pituitary Rongeur
Pinza para hipófisis cortante
Pinze per ipofisi tagliente



ø 2,2 mm

41446-02

190 mm / 7 1/2"

LANDOLT

Scharfe Hypophysenzange
Sharp Pituitary Rongeur
Pinza para hipófisis cortante
Pinze per ipofisi tagliente



ø 3,5 mm

41446-03

190 mm / 7 1/2"

YASARGIL

Scharfe Hypophysenzange
Sharp Pituitary Rongeur
Pinza para hipófisis cortante
Pinze per ipofisi tagliente



ø 9 mm

41446-09

200 mm / 8"

LANDOLT

Tumor-Faßzange, stumpf
Tumor Grasping Forceps, blunt
Pinza para tumores, roma
Pinze per ipofisi smussa

Reda Instrumente GmbH
Gänsäcker 34 - P.O. Box 131
D-78532 Tuttlingen

**MIKRO-RUNDGRIFF-
INSTRUMENTE**

**MICRO INSTRUMENTS
WITH ROUND HANDLE**

**INSTRUMENTOS PARA
MICROCIRUGÍA CON
MANGOS REDONDOS**

**STRUMENTI PER
MICROCHIRURGIA CON
MANICO ROTONDO**



REDA

www.Reda-Instrumente.de

Mikro Gefäßmesser
Micro Vessel Knives
Micro cuchillos
Micro coltelli per vasi



41230-01 185 mm / 7 1/4" KOOS



41230-02 185 mm / 7 1/4" KOOS



41230-03 185 mm / 7 1/4" KOOS



41230-05 185 mm / 7 1/4" YASARGIL



41230-06 185 mm / 7 1/4" YASARGIL

Messer, Haken, Sonden
Knives, Hooks, Probes
Bisturies, Ganchos, Sondas
Bisturi, Uncino, Sonde

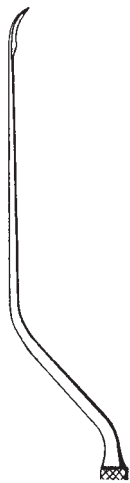

KOOS
41231-19
19 cm, 7 1/2"

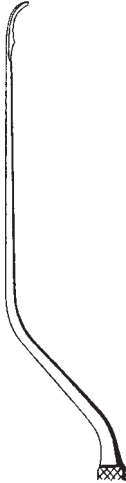

KOOS
41232-19
19 cm, 7 1/2"

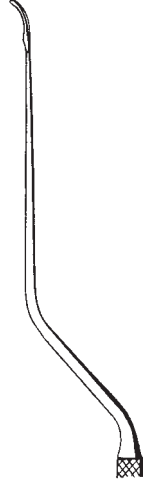

KOOS
41233-19
19 cm, 7 1/2"

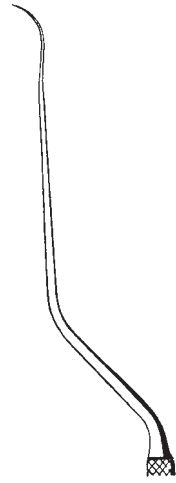

KOOS
41234-19
19 cm, 7 1/2"



FISCH
41236-19
19 cm, 7 1/2"

Durahaken
Dura Hook
Ganchito para dura-madre
Uncino dura madre



FISCH
41237-19
19 cm, 7 1/2"

Feines Häkchen
Delicate Hook
Ganchito muy fino
Uncino molto fino



JACOBSON
41238-19
19 cm, 7 1/2"

Knopfsonde
Buttoned Probe
Sonda abotonada
Sonda bottonuta



JACOBSON
41239-19
19 cm, 7 1/2"

Doppelsonde
Twin Probe
Sonda doble
Sonda doppia

Gefäßdilatoren, Gefäßspreizer
Vessel dilators, Vessel Spreader
Dilatadores vasculares, Separador para vasos
Dilatatori vascolari, Divaricatore per vasi

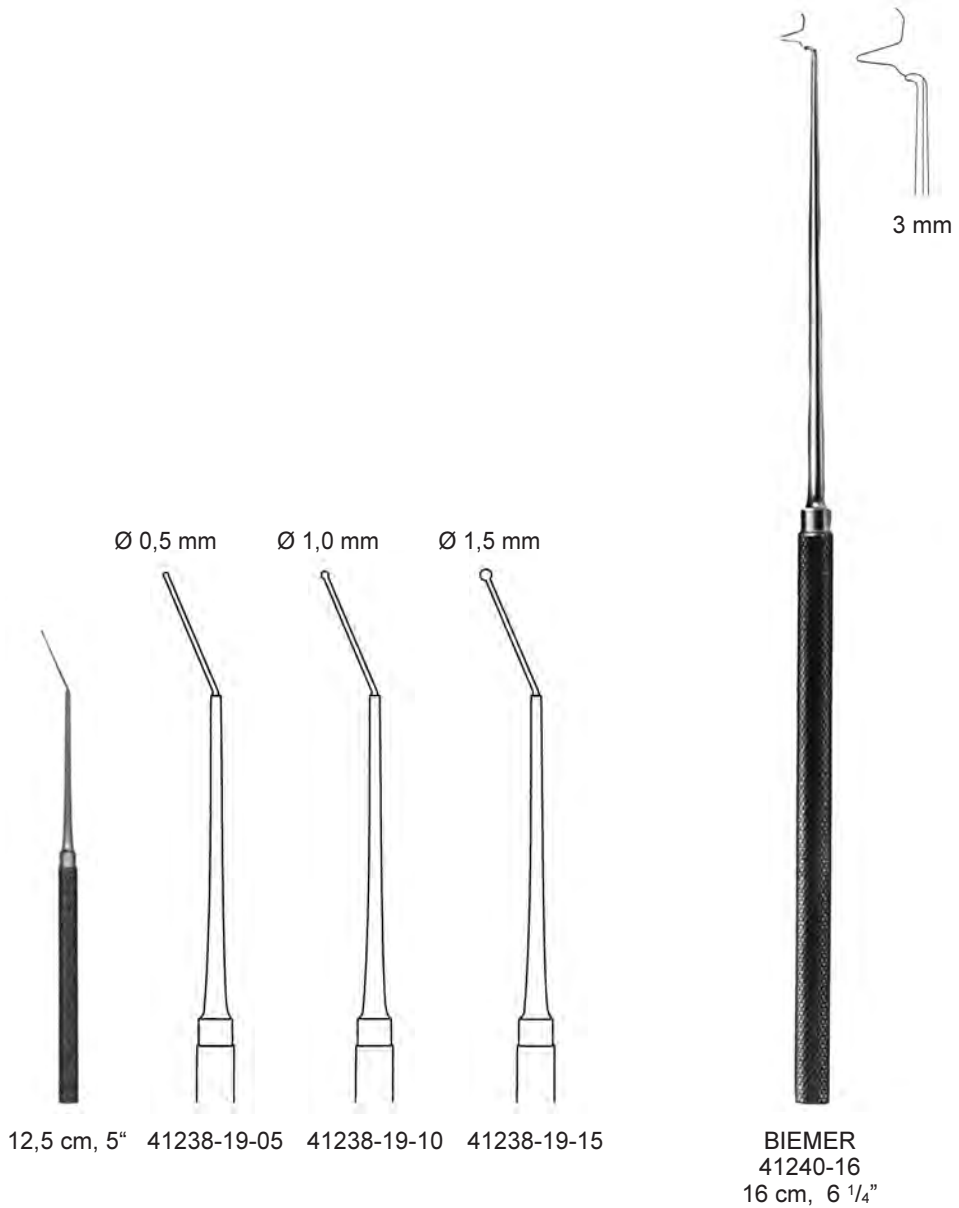

Tumormesser
Knives for tumor tissue
Cuchillos para tumores
Coltelli per tumori



SAMII

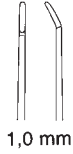

93460-20 200 mm / 8"
93460-23 230 mm / 9"



93461-20 200 mm / 8"
93461-23 230 mm / 9"

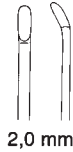

93462-20 200 mm / 8"
93462-23 230 mm / 9"

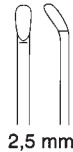

93463-20 200 mm / 8"
93463-23 230 mm / 9"

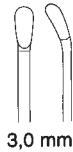

93464-20 200 mm / 8"
93464-23 230 mm / 9"



93465-20 200 mm / 8"
93465-23 230 mm / 9"



93466-20 200 mm / 8"
93466-23 230 mm / 9"



93467-20 200 mm / 8"
93467-23 230 mm / 9"

Tumormesser
Knives for tumor tissue
Cuchillos para tumores
Coltelli per tumori



SAMII

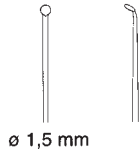

93470-20 200 mm / 8"
93470-23 230 mm / 9"

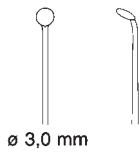

93471-20 200 mm / 8"
93471-23 230 mm / 9"

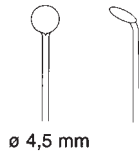

93472-20 200 mm / 8"
93472-23 230 mm / 9"

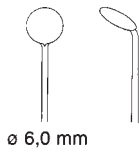

93473-20 200 mm / 8"
93473-23 230 mm / 9"

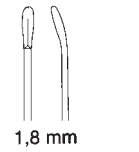

93474-23 230 mm / 9"
Lanzettenmesser
Lancet knives
Cuchillo lanceolar
Coltelli lanceolari

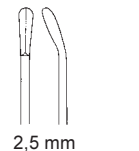

93475-23 230 mm / 9"
Lanzettenmesser
Lancet knives
Cuchillo lanceolar
Coltelli lanceolari

Fadengabel
Suture Pusher
Empujadores de suturas
Sonda Condutrice a forchetta



93500-18 185 mm / 7 1/4" JACOBSON

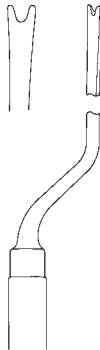

93501-23 230 mm / 9" CASPAR

Tumorgabeln
Tumor Forks
Horquillas para tumores
Forchetta per tumori



93505-01



93505-02



93505-03



93505-04

OKONEK-YASARGIL
230 mm
9"



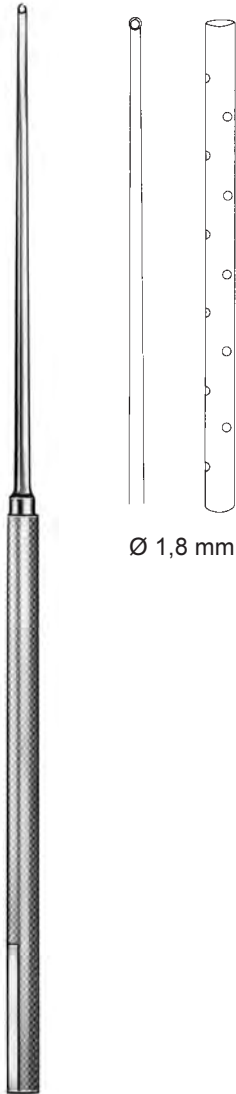













Gewebekralle
Tissue Pick
Garra para tejido
Uncini per tessuti



mit Schutzkappe
with guard
con protector
con capuccio di protezione

93510-18
185 mm
7 1/4"

Mikro-Rundgriffinstrumente
 Micro Instruments with round Handle
 Instrumentos para microcirugía con mangos redondos
 Strumenti per Microchirurgia con manico rotondo

		<p>41170-01 Ø 1 mm Raspatorium Raspatories Legra Periostotomi</p>		<p>41170-07 Ø 1,2 mm Dissektor Dissector Disector Dissettore</p>		<p>41170-11 2 mm 90° Häkchen, halbscharf Hook, semi-sharp Gancho, semi agudo Gancio, semiacuto</p>
		<p>41170-02 Ø 2 mm Raspatorium Raspatories Legra Periostotomi</p>		<p>41170-08 Ø 2,8 mm Dissektor Dissector Disector Dissettore</p>		<p>41170-12 2 mm 90° Häkchen, stumpf Hook, blunt Gancho, romo Gancio, smusso</p>
		<p>41170-03 Ø 3 mm Raspatorium Raspatories Legra Periostotomi</p>				<p>41170-13 3 mm 45° Häkchen, halbscharf Hook, semi-sharp Gancho, semi agudo Gancio, semiacuto</p>
		<p>41170-04 Ø 1 mm Dissektor, spatelförmig Dissector, spatula Disector, espatulado Dissettore, spatulate</p>				
		<p>41170-05 Ø 1,5 mm Dissektor, spatelförmig Dissector, spatula Disector, espatulado Dissettore, spatulate</p>		<p>41170-09 1 x 2 mm Scharfe Löffel, oval Curette, oval Cucharilla, oval Curette, ovale</p>		<p>41170-14 Nadel, halbscharf Needle, semi-sharp Aguja, semi agudo Ago, semiacuto</p>
		<p>41170-06 Ø 2 mm Dissektor, spatelförmig Dissector, spatula Disector, espatulado Dissettore, spatulate</p>		<p>41170-10 1 x 2 mm 45° Scharfe Löffel, oval Curette, oval Cucharilla, oval Curette, ovale</p>		<p>41170-15 90° Knopfsonde Buttoned probes Sonda abotonada Sonda bottonute</p>

RHOTON
 19 cm, 7 1/2"

Tumorgabel
Tumor fork
Horquilla para tumores
Forchette per tumori



93506-05
5 mm



93506-08
8 mm

YASARGIL
20 cm, 8"

Reda Instrumente GmbH
Gänsäcker 34 - P.O. Box 131
D-78532 Tuttlingen



HYPOPHYSEKTOMIE

HYPOPHYSECTOMY

HIPOFISECTOMÍA

IPOFISECTOMIA



www.Reda-Instrumente.de

Ringküretten
Ring Curettes
Curetas anulares
Curette anulari



33751-01
33751-02
33751-03



Ø 3 mm



Ø 6 mm



Ø 8 mm



33753-01
33753-02
33753-03

CONE
23 cm 9"

Ø 3 mm
Ø 6 mm
Ø 8 mm

Hypophyse Pinzetten
Hypophyseal Forceps
Pinzas para hipófisis
Pinze per ipofisi



ADSON
41210-23
23 cm, 9"



ADSON
41211-23
23 cm, 9"



ADSON
41213-23
23 cm, 9"

Küretten
Curette
Curetas
Curette



41221-00
19 cm, 7 1/2"



41222-00
19 cm, 7 1/2"



41223-00
19 cm, 7 1/2"



41224-00
19 cm, 7 1/2"

Hypophysektomie Instrumente
Pituitary Instruments
Instrumentos para hipófisis
Strumenti per ipofisi



CUSHING-LANDOLT

93600-01 70 x 15 mm

93600-02 90 x 15 mm

93600-03 110 x 15 mm

Spekula für trans-sphenoidale Hypophysektomie
specula for trans-sphenoidale hypophysectomy
especulos para hipofisectomía trasfenoidal
specoli per ipofisectomia trasfenoidale



Spreizzange zum Spreizen der Spekula
spreader for specula
pinza para abrir el espejulo
pinze per aprire gli specoli

LANDOLT
93605-21
210 mm, 8 1/4"

Hypophysektomie Instrumente
Pituitary Instruments
Instrumentos para hipófisis
Strumenti per ipofisi



PAPAVERO-CASPAR

93610-11 80 x 11 mm
93610-13 90 x 13 mm
93610-15 100 x 15 mm

Spekula für trans-sphenoidale Hypophysektomie
specula for trans-sphenoidale hypophysectomy
espéculos para hipofisectomía trasfenoidal
specoli per ipofisectomia trasfenoidale



PAPAVERO-HARTMANN

93615-01
140 mm, 5 1/2"

Spreizer für Spekula
spreader for specula
pinza para abrir el espéculo
pinze per aprire gli specoli

140 mm, 5 1/2"



LANDOLT
93620-14
215 mm, 8 1/2"

Hypophysektomie-Instrumente
Pituitary Instruments
Instrumentos para hipófisis
Strumenti per ipofisi



NICOLA
215 mm
8 1/4"

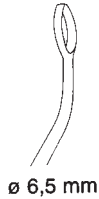

93660-01

Kürette, biegsam, nach rechts schneidend
curette, malleable, cutting to the right
cureta, maleable, cortante hacia la derecha
curetta, malleabile, tagliente a destra



93660-02

Kürette, biegsam, nach links schneidend
curette, malleable, cutting to the left
cureta, maleable, cortante hacia la izquierda
curetta, malleabile, tagliente a sinistra



93660-03

Kürette, biegsam
curette, malleable
cureta, maleable
curetta, malleabile



93660-04

Raspatorium
raspatory
legra
raspatore

Hypophysektomie-Instrumente
 Pituitary Instruments
 Instrumentos para hipófisis
 Strumenti per ipofisi



93670-01 245 mm / 9 3/4" rechts/right/derecha/a destra HARDY
 93670-02 245 mm / 9 3/4" links/left/izquierda/a sinistra

Enukleator, stumpf
 enucleator, blunt
 enucleador, romo
 enucleatore, smusso



93670-05 245 mm / 9 3/4" rechts/right/derecha/a destra HARDY
 93670-06 245 mm / 9 3/4" links/left/izquierda/a sinistra

Enukleator, scharf
 enucleator, sharp
 enucleador, cortante
 enucleatore, tagliente



93670-09 245 mm / 9 3/4" HARDY

Implantationsgabel
 implant fork
 horquilla de implante
 forchetta per trapianti



93670-10 245 mm / 9 3/4" HARDY-FAHLBUSCH

Dissektor, innen scharf
 dissector sharpened inner edge
 disector, lado interno cortante
 dissettore, lato interno sinistro tagliente



93670-12 245 mm / 9 3/4" HARDY-FAHLBUSCH

Dissektor, innen scharf
 dissector sharpened inner edge
 disector, lado interno cortante
 dissettore, lato interno destro tagliente

Hypophysektomie-Instrumente
 Pituitary Instruments
 Instrumentos para hipófisis
 Strumenti per ipofisi



93680-01 260 mm / 10 ³/₄" LANDOLT
 rechts/right/derecha/a destra

93680-02 260 mm / 10 ³/₄"
 links/left/izquierda/a sinistra

Enukleator, stumpf, biegsam
 enucleator, blunt, malleable
 enucleador, romo, maleable
 enucleatore, smusso, malleabile

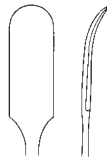

93680-05 260 mm / 10 ³/₄" LANDOLT

Kürette, biegsam
 curette, malleable
 cureta, maleable
 curetta, malleabile

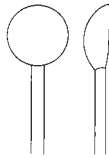

93680-06 260 mm / 10 ³/₄" LANDOLT

Löffel, biegsam
 scoop, malleable
 cucharilla, maleable
 cucchiaio, malleabile



93680-07 260 mm / 10 ³/₄" LANDOLT

stumpfes Häkchen, biegsam
 blunt hook, malleable
 gancho, romo, maleable
 uncino smusso, malleabile



93690-01 260 mm / 10 ³/₄" HOSOBUCHI

gabelförmige Spatel, fest
 fork spatula, rigid
 espátula forma horquilla, rígida
 spatola forma a forchetta, rigida

Hypophysenküretten
 Pituitary Currettes
 Cureta para hipófisis
 Curetta per ipofisi



HARDY
 24 cm, 9 1/2"
 93700-03 3 mm
 93700-05 5 mm

aufwärts gewinkelt
 angled up
 en ángulo hacia arriba
 angolato verso l'alto



HARDY
 24 cm, 9 1/2"
 93702-03 3 mm
 93702-05 5 mm

links gewinkelt
 left curved
 curvo hacia la izquierda
 curva a destra



HARDY
 24 cm, 9 1/2"
 93701-03 3 mm
 93701-05 5 mm

abwärts gewinkelt
 angled down
 ángulo hacia abajo
 angolato verso il basso



HARDY
 24 cm, 9 1/2"
 93703-03 3 mm
 93703-05 5 mm

rechts gewinkelt
 right curved
 curvo hacia la derecha
 curva a sinistra

Hypophysektomie-Instrumente
Pituitary Instruments
Instrumentos para hipófisis
Strumenti per ipofisi



HARDY
93704-24
23,5 cm, 9 1/4"

Löffel, biegsam
Spoon, malleable
Cucharilla, maleable
Cucchiaio, malleabile

5 mm









HARDY
93705-00
23 cm, 9"

Mikrospiegel
Micro mirror
Micro espejo
Micro-specchio

Hypophysektomie-Instrumente
 Pituitary Instruments
 Instrumentos para hipófisis
 Strumenti per ipofisi



	93710-01	260 mm / 10 1/4"	FAHLBUSCH Löffel, biegsam scoop, malleable cucharilla, maleable cucchiaio, malleabile
 ø 2,5 mm	93710-02	260 mm / 10 1/4"	FAHLBUSCH Kürette, biegsam curette, malleable cureta, maleable curetta, malleabile
 ø 2,2 mm	93710-03	260 mm / 10 1/4"	LANDOLT-REULEN Raspatorium, fest raspatories, rigid legra, rígida raspatore, rigido
 ø 3,2 mm	93710-04	260 mm / 10 1/4"	LANDOLT-REULEN Raspatorium, fest raspatories, rigid legra, rígida raspatore, rigido
 ø 2,5 mm	93710-05	260 mm / 10 1/4"	LANDOLT-REULEN Kürette, fest curette, rigid cureta, rígida curetta, rigido
 1,7 mm	93710-06	260 mm / 10 1/4"	LANDOLT-REULEN stumpfes Hákchen, fest blunt hook, rigid gancho, romo, rigido uncino smusso, rigida
 2,0 mm	93710-07	260 mm / 10 1/4"	LANDOLT-REULEN Dissektor, fest dissector, rigid disector, rígido dissettore, rigida

Hypophysektomie-Instrumente
 Pituitary Instruments
 Instrumentos para hipófisis
 Strumenti per ipofisi

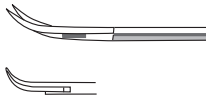
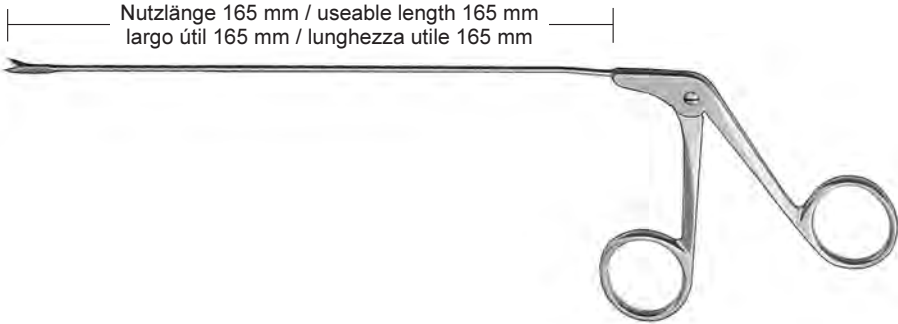

93720-01

165 mm / 6 1/2" FAHLBUSCH

Mikro-Schere, gebogen, horizontal schneidend
 Micro scissors, horizontal cutting
 Micro-tijera, curva, cortante en forma horizontal
 Micro forbice, curva, tagliente orizzontale

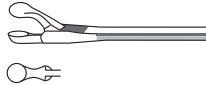

93720-02

165 mm / 6 1/2" NICOLA

Scharfe Zange
 Forceps scoop-shaped
 Pinza en forma de cuchara, cortante
 Pinze tagliente

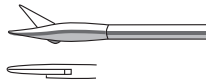

93720-03

165 mm / 6 1/2" NICOLA

Mikro-Schere, gerade
 Micro Scissors, straight
 Micro-tijera, recta
 Micro forbice, retta

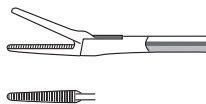

93720-04

165 mm / 6 1/2" YASARGIL-NICOLA

Faßzange
 Grasping Forceps
 Pinza de agarre
 Pinze da presa

Hypophysektomie-Instrumente
 Pituitary Instruments
 Instrumentos para hipófisis
 Strumenti per ipofisi

Nutzlänge 80 mm / useable length 80 mm
 largo útil 80 mm / lunghezza utile 80 mm

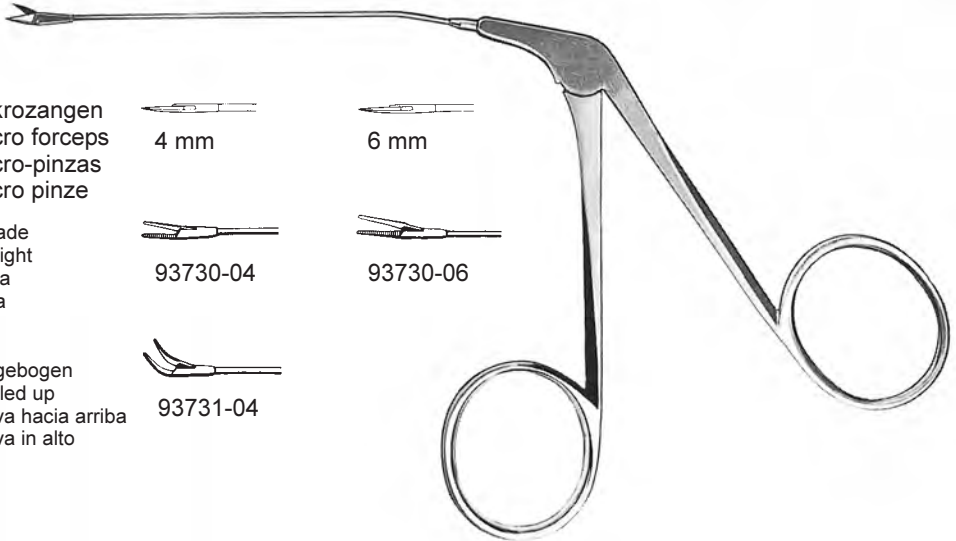

Mikrozangen
 Micro forceps
 Micro-pinzas
 Micro pinze



4 mm



6 mm

gerade
 straight
 recta
 retta



93730-04



93730-06

aufgebogen
 angled up
 curva hacia arriba
 curva in alto



93731-04

Löffelzangen
 Cup-shaped Forceps
 Pinzas en forma de cuchara
 Pinze, morso a forma di cucchiaio

gerade
 straight
 recta
 retta

rund
 round
 redondo
 rotondo



93740-01

oval
 oval
 oval
 ovale



93740-02

Mikro-Scheren
 Micro Scissors
 Micro tijeras
 Micro Forbici

gerade
 straight
 recta
 retta



93750-01

rechts gebogen
 curved right
 curva hacia la derecha
 curva a destra



93750-03

aufgebogen
 angled up
 curva hacia arriba
 curva in alto



93750-02

links gebogen
 curved left
 curva hacia la izquierda
 curva a sinistra



93750-04

Reda Instrumente GmbH
Gänsäcker 34 - P.O. Box 131
D-78532 Tuttlingen



HIRNSPATEL

BRAIN SPATULAS

ESPÁTULAS CEREBRALES

SPATOLE CEREBRALI



www.Reda-Instrumente.de

Hirnspatel
Brain Spatulas
Espátulas cerebrales
Spatole cerebrali



biegsam
malleable
maleable
malleabile

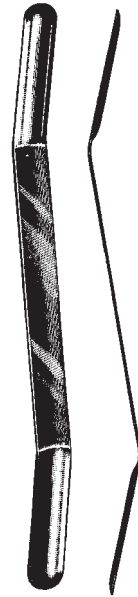

AACHEN

41249-07	7/8 x 200 mm
41249-10	10/11 x 200 mm
41249-13	13/14 x 200 mm
41249-16	16/17 x 200 mm
41249-19	19/20 x 200 mm
41249-22	22/25 x 200 mm

CUSHING

41250-11	8 x 10 mm
41250-15	13 x 15 mm
41250-18	16 x 18 mm

OLIVECRONA

41253-07	7/9 mm
41253-11	11/13 mm
41253-15	15/18 mm
41253-18	18/22 mm

Hirnspatel
Brain Spatulas
Espátulas cerebrales
Spatole cerebrali

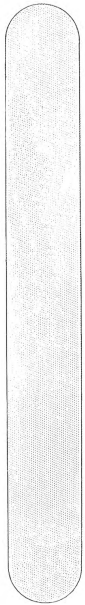

biegsam
malleable
maleable
malleabile

DAVIS
18 cm, 7"

41254-06	6 mm
41254-10	9 mm
41254-13	13 mm
41254-16	16 mm
41254-19	19 mm
41254-25	25 mm
41254-32	32 mm
41254-38	38 mm

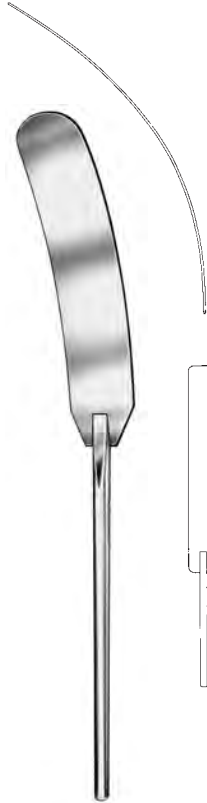

HEIFETZ

biegsam
malleable
maleable
malleabile

200 mm / 8"
41860-14 14 mm
41860-17 17 mm
41860-20 20 mm

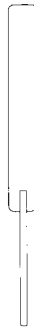

155 mm / 6"
41870-08 8 mm
41870-11 11 mm
41870-14 14 mm
41870-17 17 mm



biegsam
malleable
maleable
malleabile

41880-01	9 x 200 mm, 8"
41880-02	12 x 200 mm, 8"
41880-03	12 x 250 mm, 10"

LEYLA Retraktor System
 LEYLA Retractor System
 Separador de sistema LEYLA
 LEYLA Sistema di fissaggio



YASARGIL

41801-01 Hirnspatelhalter, flexibel, für 1 flachen Spatel, komplett, bestehend aus:
 brain retractor, flexible, for 1 flat spatula, complete, consisting of:
 separador autoretentivo, flexible, para espátula con 1 brazo flexible, completo, compuesto de:
 divaricatore autostatico, flessibile, per spatole piatte, con 1 braccio flessibile, completo, composto da:

41810-10 flexibler Spannarm
 flexible arm
 brazo flexible
 braccio flessibile

41826-26 Fixiervorrichtung für 1 flexiblen Spannarm
 fixation base for 1 flexible arm
 fijador para 1 brazo flexible
 fissatore per 1 braccio al braccio rigido

41830-30 Spatelhalter für flache Spatel
 support for flat brain spatula
 soporte para espátulas cerebrales planas
 sostegno per spatole piatte

YASARGIL

41802-02 Hirnspatelhalter, flexibel für 2 flache Spatel, komplett, bestehend aus:
 brain retractor, flexible, for 2 flat spatulas, complete, consisting of:
 separador autoretentivo, flexible, para 2 espátulas planas con 2 brazos flexibles, completo, compuesto de:
 divaricatore autostatico, flessibile, per spatole piatte, con 2 bracci flessibili, completo, composto da:



41810-10 flexibler Spannarm (2x)
 flexible arm (2x)
 brazo flexible (2x)
 braccio flessibile (2x)

41822-22 Fixiervorrichtung für 2 flexible Spannarme
 fixation base for 2 flexible arms
 fijador para 2 brazos
 fissatore per 2 bracci al cranio

41830-30 Spatelhalter für flache Spatel (2x)
 support for flat brain spatula (2x)
 soporte para espátulas cerebrales planas (2x)
 sostegno per spatole piatte (2x)

LEYLA Retraktor System
LEYLA Retractor System
Separador de sistema LEYLA
LEYLA Sistema di fissaggio

41821-21

Fixiervorrichtung für 1 flexiblen Spannarm zum Festschrauben an Rohrteilen bis \varnothing 16 mm

Fixation base for mounting on bars up to \varnothing 16 mm, for 1 flexible arm

Fijador para 1 brazo flexible, para atornillar a tubos hasta 16 mm

Fissatore per 1 braccio al braccio rigido



41822-22

Fixiervorrichtung für 2 flexible Spannarme zum Festschrauben am Schädel

Fixation base for skull mounting, holding 2 flexible arms

Fijador para 2 brazos flexibles, para atornillar al cráneo

Fissatore per 2 bracci al cranio



41826-26

Fixiervorrichtung für 1 flexiblen Spannarm zum Festschrauben am Schädel

Fixation base for skull mounting, holding 1 flexible arm

Fijador para 1 brazos flexibles, para atornillar al cráneo

Fissatore per 1 braccio al cranio



41830-30

Spatelhalter für flache Hirnspatel zur Befestigung am Spannarm

Support for flat brain spatula

Soporte para espátulas cerebrales planas para fijación al brazo flexible

Sostegno per spatole piatte



41832-32

Halter für Hirnspatel mit rundem Schaft bis \varnothing 5,5 mm zur Befestigung am Spannarm

Support for brain spatula with round shaft

Soporte para espátulas cerebrales con mango redondo hasta \varnothing 5,5 mm para fijación al brazo flexible

Sostegno flessibile per spatola cerebrale



LEYLA Retraktor System
 LEYLA Retractor System
 Separador de sistema LEYLA
 LEYLA Sistema di fissaggio



YASARGIL

- 41810-10 flexibler Spannarm, allein
 flexible arm, only
 brazo flexible, suelto
 braccio flessibile, solo

YASARGIL

- 41803-01 Ohrspekulahalter, komplett, bestehend aus:
 ear specula holder, complete, consisting of:
 soporte para espejos auriculares completo,
 compuesto de:
 sostegno per specchio auricolare, completo
 composto da:

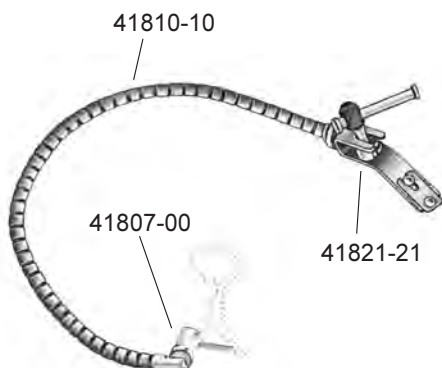

- 41810-10 flexibler Spannarm
 flexible arm, only
 brazo flexible, suelto
 braccio flessibile, solo
- 41821-21 Fixiervorrichtung zum Befestigen an Rohrteilen
 bis Ø 16 mm
 clamp for fixation on bars up to Ø 16 mm
 fijador para 1 brazo flexible, para atornillar a
 tubos hasta 16 mm
 fissatore al braccio rigido Ø 16 mm
- 41807-00 Ohrtrichterhalter, allein
 ear specula holder, only
 soporte para espejos auriculares, suelto
 sostegno per specchio auricolare

LEYLA Retraktor System
 LEYLA Retractor System
 Separador de sistema LEYLA
 LEYLA Sistema di fissaggio

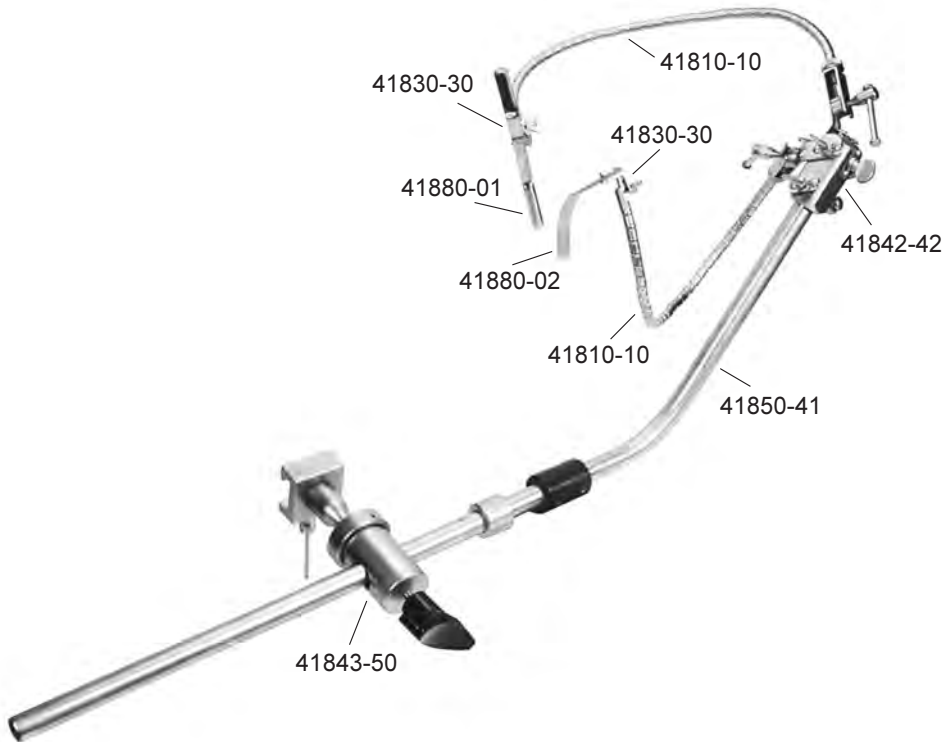

41802-00 LEYLA-Retraktor-System zum Fixieren am OP-Tisch komplett, bestehend aus:
 LEYLA Self-Retraining Retractor for fixation to operating table, complete, consisting of:
 Separador LEYLA para fijacion a la mesa de operaciones, completo, compuesto de:
 LEYLA Sistema di fissaggio al tavolo operatorio, composto da:

- | | |
|---|--|
| 41843-50 Kugelgelenkkloben (1x)
ball and socket joint (1x)
articulacion esferica (1x)
giunto per fissare (1x) | 41830-30 Spatelhalter für flache Spatel (2x)
support for flat brain spatula (2x)
soporte para espátulas cerebrales planas (2x)
sostegno per spatole piatte (2x) |
| 41850-41 starrer Haltearm (1x)
rigid holding rod (1x)
brazo de fijación rigido (1x)
braccio di fissaggio rigido (1x) | 41880-01 CUSHING Hirnspatel (1x)
CUSHING brain spatula (1x)
CUSHING espatula para cerebro (1x)
CUSHING spatola cerebrale (1x) |
| 41842-42 Kupplungskopf (1x)
coupling head (1x)
cabeza de acoplamiento (1x)
giunto per combinare (1x) | 41880-02 CUSHING Hirnspatel (1x)
CUSHING brain spatula (1x)
CUSHING espatula para cerebro (1x)
CUSHING spatola cerebrale (1x) |
| 41810-10 flexibler Spannarm (2x)
flexible arm, only (2x)
brazo flexible, suelto (2x)
braccio flessibile, solo (2x) | |

LEYLE Retraktor System
 LEYLE Retractor System
 Separador de sistema LEYLE
 LEYLE Sistema di fissaggio



- 41843-50 Kugelgelenkkloben zum Befestigen an der OP-Tischschiene und zur Aufnahme des Haltearms 41850-41
 ball and socket joint for fixation of holding rod 41850-41 at the operating table
 articulation esferica, para sujetar el brazo de soporte rigido sobre la mesa de operaciones 9 x 32 mm
 giunto per fissare il braccio, articolato 9 x 32 mm



- 41850-41 starrer Haltearm, auseinandernehmbar, zur Fixation im Kugelgelenkkloben 41843-50 und zur wahlweisen Aufnahme der Kupplungsköpfe 41842-42, 41842-44 und 41842-46
 holding rod, detachable, for fixation in ball and socket joint 41843-50 and to hold a desired coupling head 41842-42, 41842-44 or 41842-46
 brazo de soporte rigido, desmontable, para fijacion a la articulation esferica 41843-50 y opcionalmente a las cabezas 41842-42, 41842-44 y 41842-46
 braccio di sostegno rigido, per fissaggio al giunto 41843-50 e dei giunti 41842-42, 41842-44 e 41842-46



- 41842-42 Kupplungskopf, zur Aufnahme von max. 5 flexiblen Spannarmen 41810-10
 coupling head to hold 5 flexible arms 41810-10
 cabeza de acoplamiento para fijar hasta 5 brazos flexibles
 giunto per combinare 5 bracci



- 41842-44 Kupplungskopf, drehbar, zur Aufnahme von 1 flexiblen Spannarm 41810-10
 coupling head, turnable, to hold 1 flexible arm 41810-10
 acoplamiento, girable y se puede fijar en todas las posturas para sujetar un brazo flexible 41810-10
 giunto per combinare, rotabile, per sostegno del braccio 41810-10

- 41842-46 Kupplungskopf, seitlich offen zur Aufnahme von 1 flexiblen Spannarm 41810-10
 coupling head, lateral open, to hold 1 flexible arm 41810-10
 acoplamiento, abierto al lado, para un brazo flexible 41810-10
 giunto per fissare il braccio, per 41810-10

Reda Instrumente GmbH
Gänsäcker 34 - P.O. Box 131
D-78532 Tuttlingen



STANZEN

PUNCHES

PINZAS SACABOCADO

PINZE LAMINOTOMO







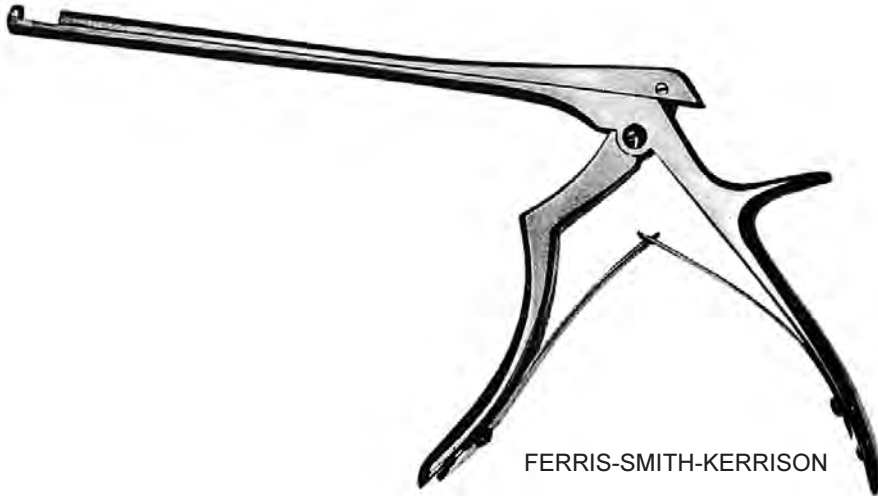

www.Reda-Instrumente.de

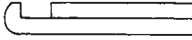
Bandscheibenstanzen
 Intervertebral Disc Rongeurs
 Pinzas sacabocado para discos intervertebrales
 Pinze taglianti per dischi intervertebrali

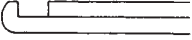
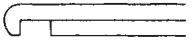
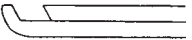
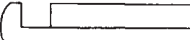
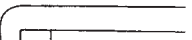
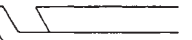
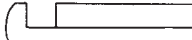
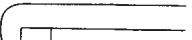

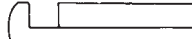
FERRIS-SMITH-KERRISON

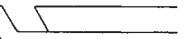
	90°	90°	40°
18 cm, 7" 20 cm, 8"	 41510-01 1 mm 41513-01 1 mm	 41511-01 1 mm 41514-01 1 mm	 41512-01 1 mm 41515-01 1 mm
18 cm, 7" 20 cm, 8"	 41510-02 2 mm 41513-02 2 mm	 41511-02 2 mm 41514-02 2 mm	 41512-02 2 mm 41515-02 2 mm
18 cm, 7" 20 cm, 8"	 41510-03 3 mm 41513-03 3 mm	 41511-03 3 mm 41514-03 3 mm	 41512-03 3 mm 41515-03 3 mm
18 cm, 7" 20 cm, 8"	 41510-04 4 mm 41513-04 4 mm	 41511-04 4 mm 41514-04 4 mm	 41512-04 4 mm 41515-04 4 mm
18 cm, 7" 20 cm, 8"	 41510-05 5 mm 41513-05 5 mm	 41511-05 5 mm 41514-05 5 mm	 41512-05 5 mm 41515-05 5 mm



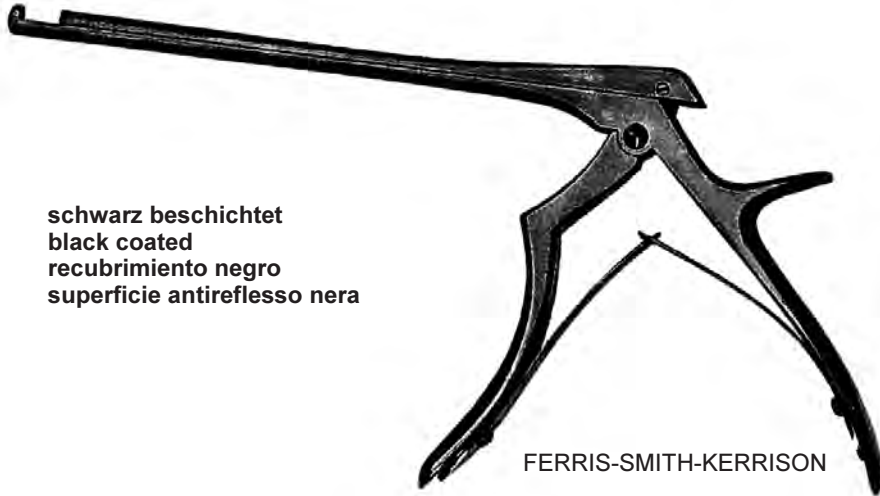

auch lieferbar mit Dünnpfuß
 also available with thin foot plate
 tambien disponible con lámina de punzonar estrecha
 anche disponibile con morso sottile

Bandscheibenstanzen
 Intervertebral Disc Rongeurs
 Pinzas sacabocado para discos intervertebrales
 Pinze taglianti per dischi intervertebrali

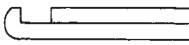
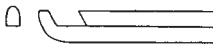

schwarz beschichtet
 black coated
 recubrimiento negro
 superficie antireflesso nera

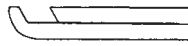
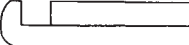
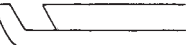
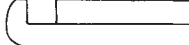
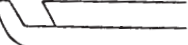
FERRIS-SMITH-KERRISON

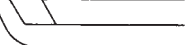
	90°	40°
18 cm, 7"	 41510-01B 1 mm	 41512-01B 1 mm
20 cm, 8"	41513-01B 1 mm	41515-01B 1 mm
18 cm, 7"	 41510-02B 2 mm	 41512-02B 2 mm
20 cm, 8"	41513-02B 2 mm	41515-02B 2 mm
18 cm, 7"	 41510-03B 3 mm	 41512-03B 3 mm
20 cm, 8"	41513-03B 3 mm	41515-03B 3 mm
18 cm, 7"	 41510-04B 4 mm	 41512-04B 4 mm
20 cm, 8"	41513-04B 4 mm	41515-04B 4 mm
18 cm, 7"	 41510-05B 5 mm	 41512-05B 5 mm
20 cm, 8"	41513-05B 5 mm	41515-05B 5 mm

Bandscheibenstanzen, zerlegbar
Intervertebral Disc Rongeurs, dismantable
Pinzas sacabocado para discos intervertebrales, desmontable
Pinze taglianti per dischi intervertebrali, smontabile a fucile

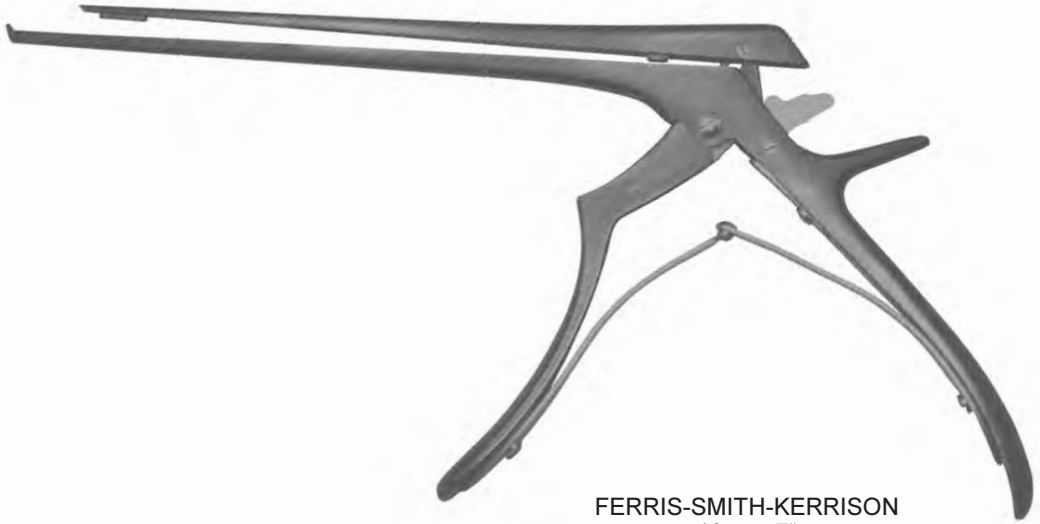

FERRIS-SMITH-KERRISON
18 cm, 7"

90°

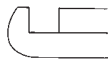

41540-02 2 mm
41540-03 3 mm
41540-04 4 mm
41540-05 5 mm

130°



41542-02 2 mm
41542-03 3 mm
41542-04 4 mm
41542-05 5 mm

Bandscheibenstanzen, zerlegbar
Intervertebral Disc Rongeurs, dismantable
Pinzas sacabocado para discos intervertebrales, desmontable
Pinze taglianti per dischi intervertebrali, smontabile a fucile



schwarz beschichtet
black coated
recubrimiento negro
superficie antireflesso nera

FERRIS-SMITH-KERRISON
18 cm, 7"

90°

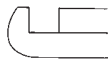

- 41540-02B 2 mm
- 41540-03B 3 mm
- 41540-04B 4 mm
- 41540-05B 5 mm

130°



- 41542-02B 2 mm
- 41542-03B 3 mm
- 41542-04B 4 mm
- 41542-05B 5 mm

Bandscheibenstanzen
Intervertebral Disc Rongeurs
Pinzas sacabocado para discos intervertebrales
Pinze taglianti per dischi intervertebrali

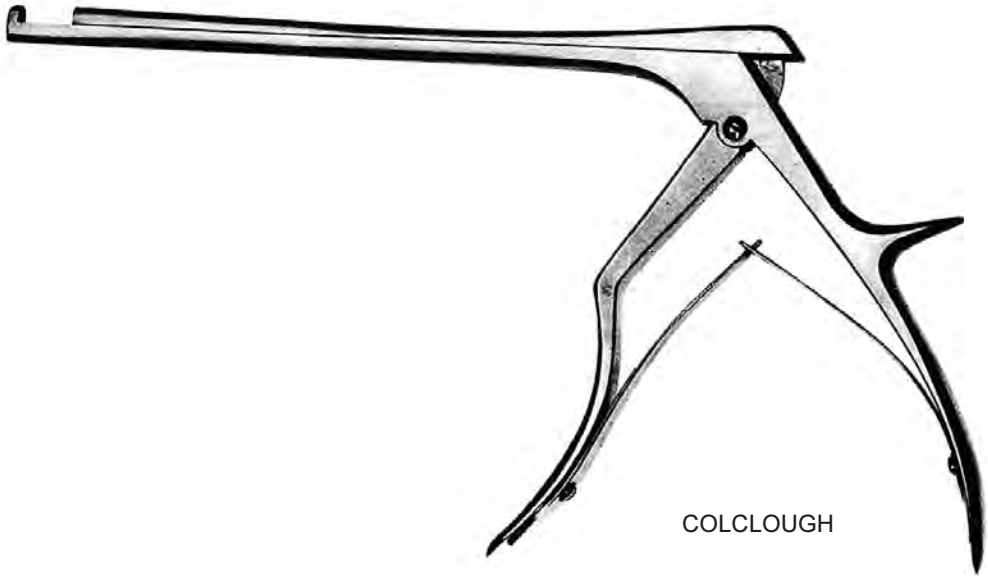

COLCLOUGH

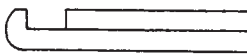

3 mm

41520-03 15 cm, 6"
41522-03 20 cm, 8"



5 mm

41520-05 15 cm, 6"
41522-05 20 cm, 8"



3 mm

41524-03 15 cm, 6"
41526-03 20 cm, 8"



5 mm

41524-05 15 cm, 6"
41526-05 20 cm, 8"

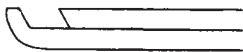

3 mm

41527-03 15 cm, 6"
41529-03 20 cm, 8"

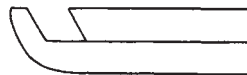

5 mm

41527-05 15 cm, 6"
41529-05 20 cm, 8"

Stanzen
Punches
Pinzas
Pinze-Punzoni



KERRISON
17 cm, 6 3/4"
3x3 mm 47303-03
4x4 mm 47303-04
5x5 mm 47303-05
6x6 mm 47303-06

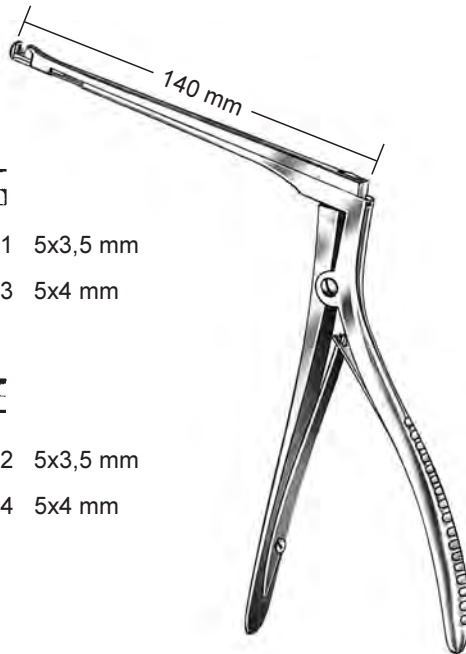

⌒ 47304-01 5x3,5 mm

⌒ 47304-03 5x4 mm



⌒ 47304-02 5x3,5 mm

⌒ 47304-04 5x4 mm

HAJEK-KOFLER
47304-01 - 47304-04

Stanzen
Punches
Pinzas
Pinze-Punzoni



CITELLI

47311-10 1,0 mm
47311-25 2,5 mm
47311-30 3,0 mm

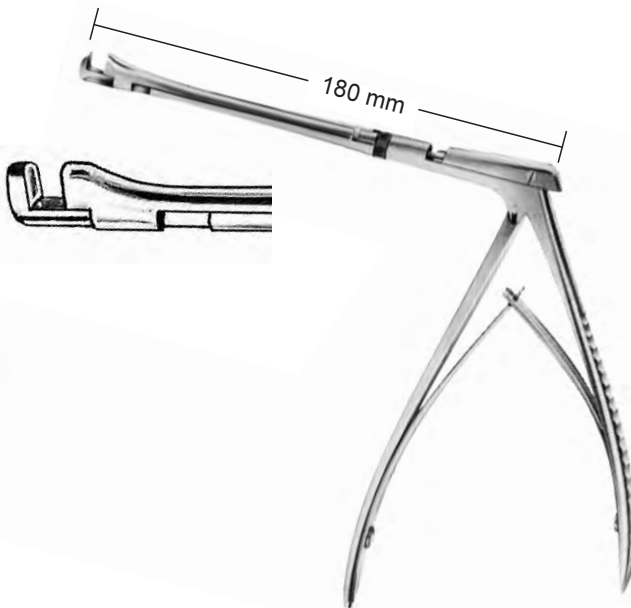

HAJEK-KOFLER
47316-16
3,5 mm

Reda Instrumente GmbH
Gänsäcker 34 - P.O. Box 131
D-78532 Tuttlingen

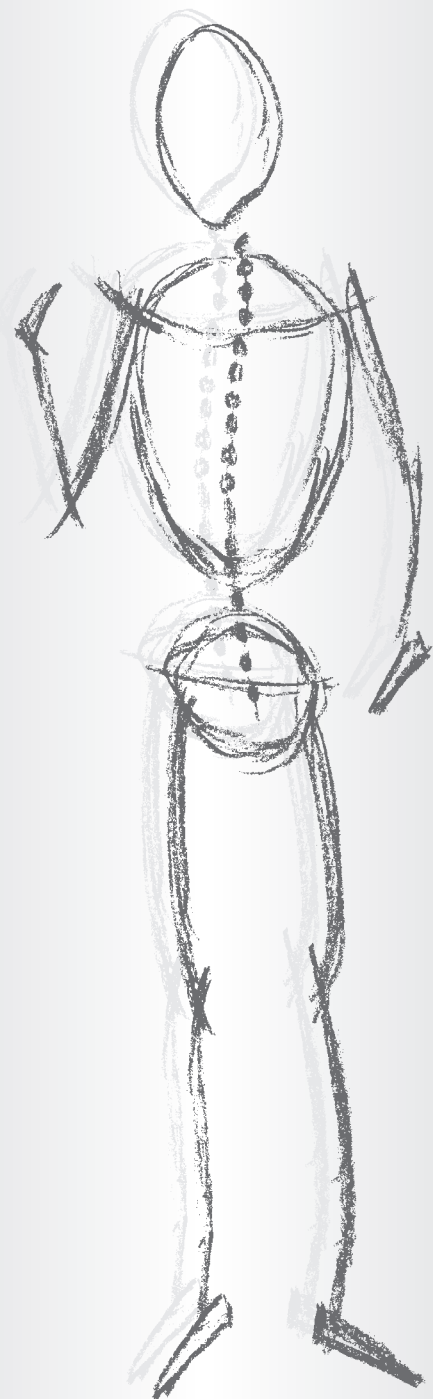

CLIPS

CLIPS

CLIPS

CLIPS PER ANEURISMA



www.Reda-Instrumente.de

YASARGIL – Aneurysmen – Gefäß – Clips
YASARGIL – Aneurysm – Vessel – Clips
YASARGIL – Clips para aneurisma
YASARGIL – Clips per aneurisma

aus hochwertigem Implantat-Stahl antimagnetisch
in high quality Implant steel antimagnetic
de acero inoxidable para implantes de alta calidad, antimagnético
Prodotto in acciaio di alta qualità, antimagnetico

Features of the Clip

SERIAL-NUMBER

Each clip is coded with an individual serial number – marked by laser technology-
The serial number guarantees a detailed follow-up of

- the whole production process
- the closure force
- from raw material to the final product

These informations are registered in our company for the period of 10 years.

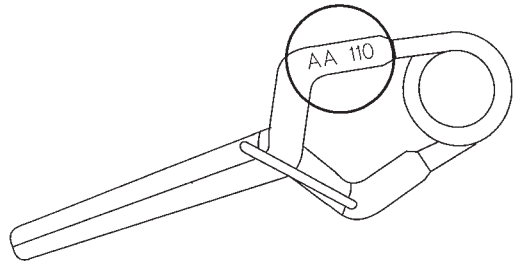

PACKING – LABELING

Each clip is individually packaged in a transparent box made of resistant plastic.
Special wishes of customers regarding the packaging will be considered by us. This will be marked on an internal instruction.

The transparent box is marked with a label in order to assure a quick and sure identification of the clip.

On the label you can find the following data:

- catalogue number
- Product description
- Illustration
- Closing force in g
- Tolerance range of closing force
- Blade length
- Maximum opening
- Blade geometry
- Serial number
- Jaw profile
- Material description
- Lot number
- the notes “NOT STERILE”
- WARNING

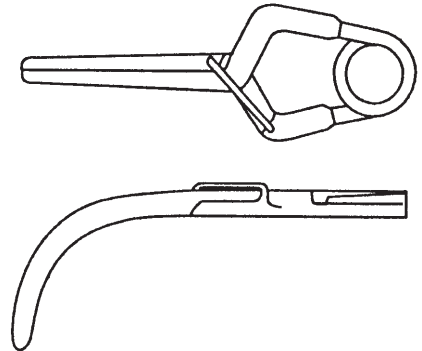

YASARGIL – Aneurysmen – Gefäß – Clips
YASARGIL – Aneurysm – Vessel – Clips
YASARGIL – Clips para aneurisma
YASARGIL – Clips per aneurisma

aus hochwertigem Implantat-Stahl antimagnetisch
in high quality Implant steel antimagnetic
de acero inoxidable para implantes de alta calidad, antimagnético
Prodotto in acciaio di alta qualità, antimagnetico

Features of the Clip

JAW-PROFILE

The rounded, pyramid-like structure is stamped into the jaw through a special step in production and prevents sharp edges which could perforate an aneurysm

No edges or burrs through additional rounding of structures that border the clip outer side because of this, real atraumatic application of the clip

Increased surface area due to the pyramid-like design of the jaws inner surface the cross-like structure of the inner jaws pyramid surface doubles the tissue-holding area.

The applied pressure distributes itself evenly over the length of the jaw.

The convex closure of the clip assures an atraumatic and secure closure of the aneurysm.

Sliding of the clip is prevented.

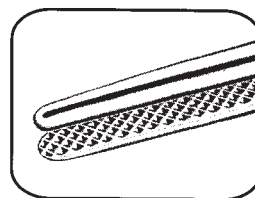
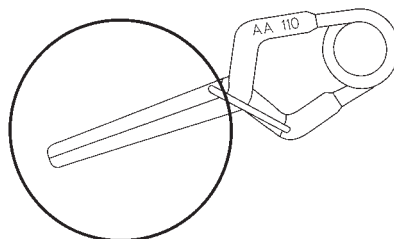

SPRING-DESIGN

The spring size, which is different in the Standard and Mini clips, is the same within the same type of the Clip.

Through this, the highest degree of a secure fit is ensured by the clip applicator (clip/clip applicator fit)

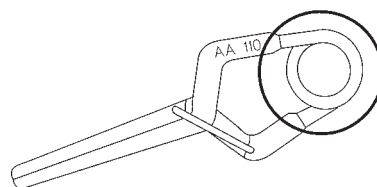

LINK-DESIGN

Laser welded

The link ensures the precise guidance of the jaws and a “soft” opening of the clip during the whole spreading process.

The contact surface of the jaws are guided symmetrically in an exact way “over the whole length” this fact guarantees an additional stability of the clip.

No over-stress of the material because the design of the link limits the maximum opening width.

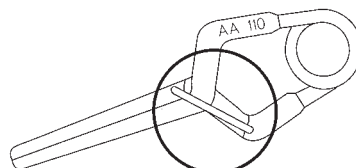

YASARGIL – Aneurysmen – Gefäß – Clips
YASARGIL – Aneurysm – Vessel – Clips
YASARGIL – Clips para aneurisma
YASARGIL – Clips per aneurisma

aus hochwertigem Implantat-Stahl antimagnetisch
in high quality Implant steel antimagnetic
de acero inoxidable para implantes de alta calidad, antimagnético
Prodotto in acciaio di alta qualità, antimagnetico

Features of the Clip

CLOSING-FORCE

The closing force is measured at one third of the jaw length and an opening of 0,5 mm.

The final quality control of the clip is effected by a microprocessor-controlled measuring equipment.

The closing force is indicated exactly within a certain tolerance.

By the help of a special software program we assure that before the clip passes the final quality control its closure force is fixed.

As a consequence we exclude any kind of manipulation.

All relevant technical data are stored during the control procedure and printed on the label.

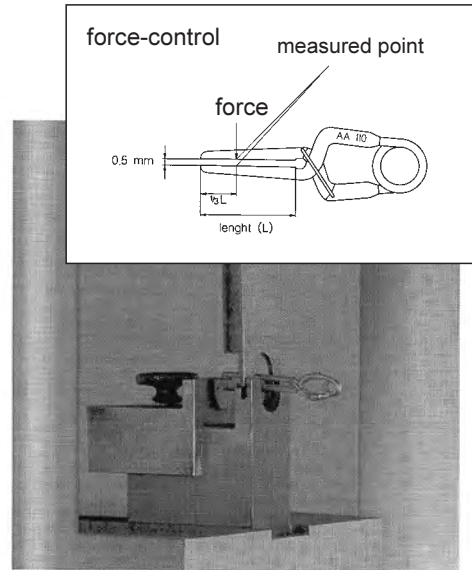

Material and Quality Assurance

According to DIN 17445, implant steel is used in the production of our Aneurysm Clip

High stability characteristics

Excellent tissue compatibility

Secure closure of blood vessels

Antimagnetic

Ideally suited as implantation material

Security against over straining

YASARGIL – Aneurysmen – Gefäß – Clips
YASARGIL – Aneurysm – Vessel – Clips
YASARGIL – Clips para aneurisma
YASARGIL – Clips per aneurisma

aus hochwertigem Implantat-Stahl antimagnetisch
in high quality Implant steel antimagnetic
de acero inoxidable para implantes de alta calidad, antimagnético
Prodotto in acciaio di alta qualità, antimagnetico

Erklärung zum Katalog-System
Instructions for the catalogue-system
Explicaciones para el sistema del catálogo
Esempio del sistema del catalogo

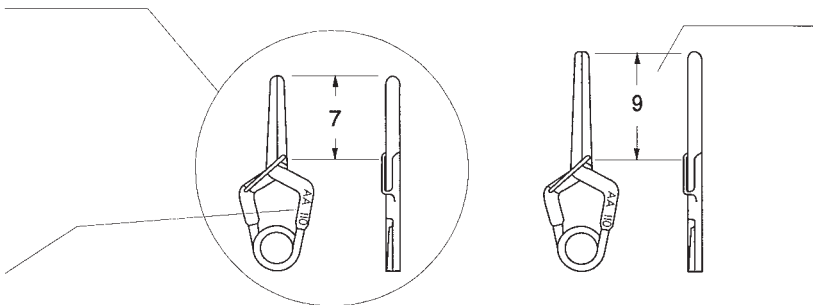

YASARGIL – Aneurysmen – Gefäß – Clips
 YASARGIL – Aneurysm – Vessel – Clips
 YASARGIL – Clips para aneurisma
 YASARGIL – Clips per aneurisma

aus hochwertigem Implantat-Stahl antimagnetisch
 in high quality Implant steel antimagnetic
 de acero inoxidable para implantes de alta calidad, antimagnético
 Prodotto in acciaio di alta qualità, antimagnetico

YASARGIL-STANDARD für permanenten Verschluss
 YASARGIL-STANDARD for permanent closure
 YASARGIL-STANDARD para cierre permanente
 YASARGIL-STANDARD con chiusura permanente

Standard

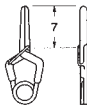

Cat. Nr. 41600-62
41600-62 T
 max. opening 6,2 mm
 Force 150 gms

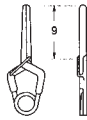

Cat. Nr. 41600-70
41600-70 T
 max. opening 7,0 mm
 Force 180 gms

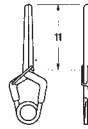

Cat. Nr. 41600-78
41600-78 T
 max. opening 7,8 mm
 Force 180 gms

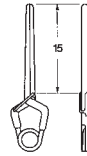

Cat. Nr. 41600-92
41600-92 T
 max. opening 9,2 mm
 Force 200 gms

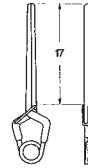

Cat. Nr. 41601-10
41601-10 T
 max. opening 10,6 mm
 Force 200 gms

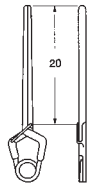

Cat. Nr. 41601-11
41601-11 T
 max. opening 11,4 mm
 Force 200 gms



Cat. Nr. 41601-13
41601-13 T
 max. opening 13,3 mm
 Force 200 gms

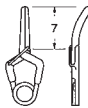

Cat. Nr. 41602-60
41602-60 T
 max. opening 6,0 mm
 Force 150 gms

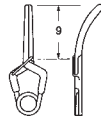

Cat. Nr. 41602-68
41602-68 T
 max. opening 6,8 mm
 Force 180 gms

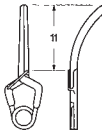

Cat. Nr. 41602-75
41602-75 T
 max. opening 7,5 mm
 Force 180 gms

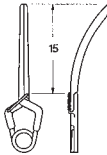

Cat. Nr. 41602-87
41602-87 T
 max. opening 8,7 mm
 Force 200 gms

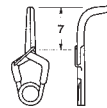

Cat. Nr. 41603-55
41603-55 T
 max. opening 5,5 mm
 Force 150 gms

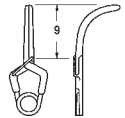

Cat. Nr. 41603-61
41603-61 T
 max. opening 6,1 mm
 Force 180 gms

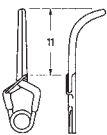

Cat. Nr. 41603-65
41603-65 T
 max. opening 6,5 mm
 Force 180 gms

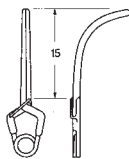

Cat. Nr. 41603-74
41603-74 T
 max. opening 7,4 mm
 Force 200 gms

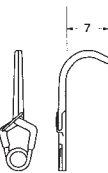

Cat. Nr. 41604-54
41604-54 T
 max. opening 5,4 mm
 Force 180 gms

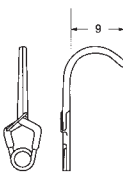

Cat. Nr. 41604-58
41604-58 T
 max. opening 5,8 mm
 Force 180 gms

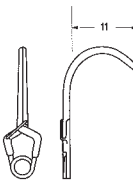

Cat. Nr. 41604-62
41604-62 T
 max. opening 6,2 mm
 Force 180 gms

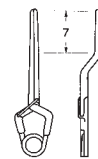

Cat. Nr. 41604-79
41604-79 T
 max. opening 7,9 mm
 Force 200 gms

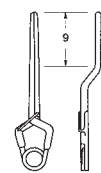

Cat. Nr. 41604-87
41604-87 T
 max. opening 8,7 mm
 Force 200 gms

YASARGIL – Aneurysmen – Gefäß – Clips
 YASARGIL – Aneurysm – Vessel – Clips
 YASARGIL – Clips para aneurisma
 YASARGIL – Clips per aneurisma

aus hochwertigem Implantat-Stahl antimagnetisch
 in high quality Implant steel antimagnetic
 de acero inoxidable para implantes de alta calidad, antimagnético
 Prodotto in acciaio di alta qualità, antimagnetico

YASARGIL-STANDARD für permanenten Verschluss
 YASARGIL-STANDARD for permanent closure
 YASARGIL-STANDARD para cierre permanente
 YASARGIL-STANDARD con chiusura permanente

Standard

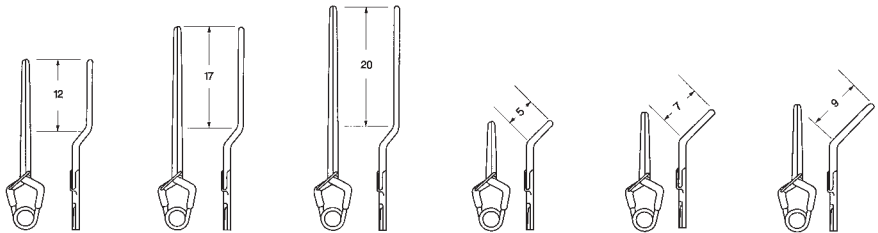

Cat. Nr.	41605-10 41605-10 T	41605-12 41605-12 T	41605-13 41605-13 T	41606-62 41606-62-T	41606-65 41606-65 T	41606-78 41606-78 T
max. opening	10,2 mm	11,9 mm	13,0 mm	6,2 mm	6,5 mm	7,8 mm
Force	200 gms	180 gms	180 gms	200 gms	200 gms	200 gms

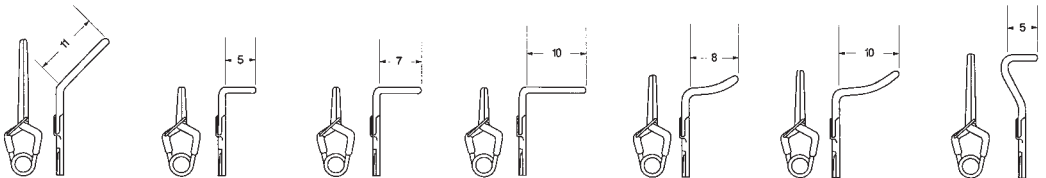

41606-84 41606-84 T	41607-56 41607-56 T	41607-57 41607-57 T	41607-58 41607-58 T	41607-59 41607-59 T	41607-60 41607-60 T	41607-72 41607-72 T
8,4 mm	5,6 mm	5,6 mm	5,6 mm	5,4 mm	5,6 mm	7,2 mm
200 gms	200 gms	200 gms	200 gms	200 gms	200 gms	200 gms

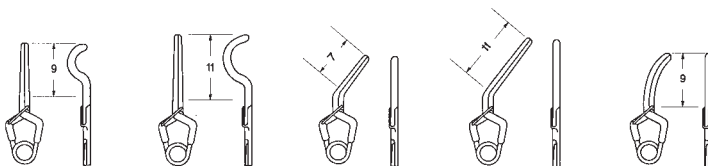

41607-73 41607-73 T	41607-82 41607-82 T	41608-57 41608-57 T	41608-80 41608-80 T	41609-70 41609-70 T
7,2 mm	8,2 mm	5,7 mm	8,0 mm	7,0 mm
200 gms	200 gms	200 gms	200 gms	200 gms

YASARGIL – Aneurysmen – Gefäß – Clips
 YASARGIL – Aneurysm – Vessel – Clips
 YASARGIL – Clips para aneurisma
 YASARGIL – Clips per aneurisma

aus hochwertigem Implantat-Stahl antimagnetisch
 in high quality Implant steel antimagnetic
 de acero inoxidable para implantes de alta calidad, antimagnético
 Prodotto in acciaio di alta qualità, antimagnetico

YASARGIL-STANDARD für temporären Verschluss
 YASARGIL-STANDARD for temporary closure
 YASARGIL-STANDARD para cierre temporal
 YASARGIL-STANDARD con chiusura temporanea

Standard

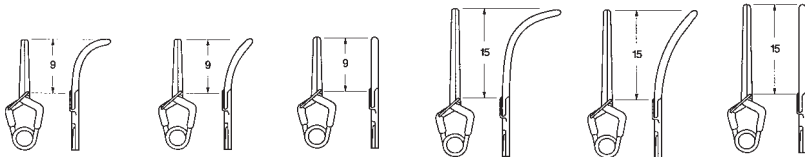

Cat. Nr.	41610-61 41610-61 T	41610-68 41610-68 T	41610-70 41610-70 T	41611-74 41611-74 T	41611-87 41611-87 T	41611-92 41611-92 T
max. opening	6,1 mm	6,8 mm	7,0 mm	7,4 mm	8,7 mm	9,2 mm
Force	70 gms	70 gms	70 gms	70 gms	70 gms	70 gms

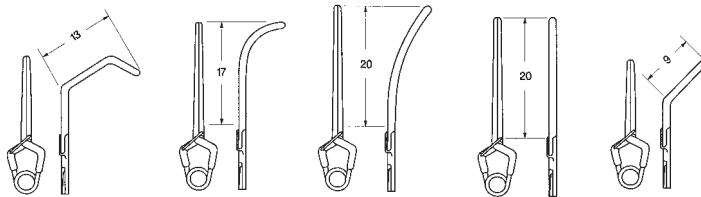

41612-07 41612-07 T	41612-09 41612-09 T	41612-11 41612-11 T	41612-12 41612-12 T	41612-62 41612-62 T
7,5 mm	9,9 mm	11,0 mm	11,4 mm	6,2 mm
90 gms	90 gms	90 gms	90 gms	70 gms

YASARGIL – Aneurysmen – Gefäß – Clips
 YASARGIL – Aneurysm – Vessel – Clips
 YASARGIL – Clips para aneurisma
 YASARGIL – Clips per aneurisma

aus hochwertigem Implantat-Stahl antimagnetisch
 in high quality Implant steel antimagnetic
 de acero inoxidable para implantes de alta calidad, antimagnético
 Prodotto in acciaio di alta qualità, antimagnetico

YASARGIL-STANDARD für permanenten Verschluss
 YASARGIL-STANDARD for permanent closure
 YASARGIL-STANDARD para cierre permanente
 YASARGIL-STANDARD con chiusura permanente

Standard

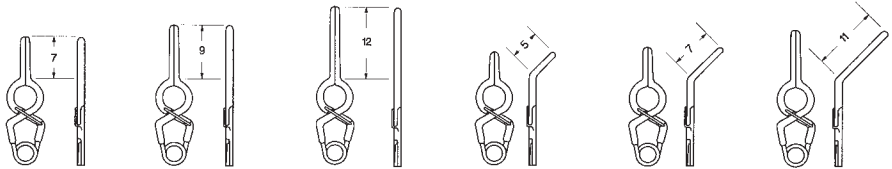

Cat. Nr.	41613-74	41613-84	41613-96	41614-58	41614-65	41614-72
	41613-74 T	41613-84 T	41613-96 T	41614-58 T	41614-65 T	41614-72 T
max. opening	7,4 mm	8,4 mm	9,6 mm	5,8 mm	6,5 mm	7,2 mm
Force	150 gms	150 gms	180 gms	150 gms	150 gms	180 gms

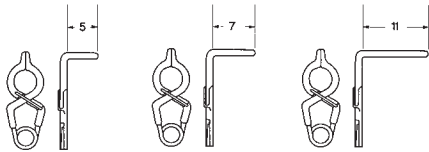

41615-49	41615-50	41615-51
41615-49 T	41615-50 T	41615-51 T
4,9 mm	4,9 mm	4,9 mm
150 gms	150 gms	180 gms

YASARGIL – Aneurysmen – Gefäß – Clips
 YASARGIL – Aneurysm – Vessel – Clips
 YASARGIL – Clips para aneurisma
 YASARGIL – Clips per aneurisma

aus hochwertigem Implantat-Stahl antimagnetisch
 in high quality Implant steel antimagnetic
 de acero inoxidable para implantes de alta calidad, antimagnético
 Prodotto in acciaio di alta qualità, antimagnetico

YASARGIL-STANDARD für permanenten Verschluss
 YASARGIL-STANDARD for permanent closure
 YASARGIL-STANDARD para cierre permanente
 YASARGIL-STANDARD con chiusura permanente

Standard

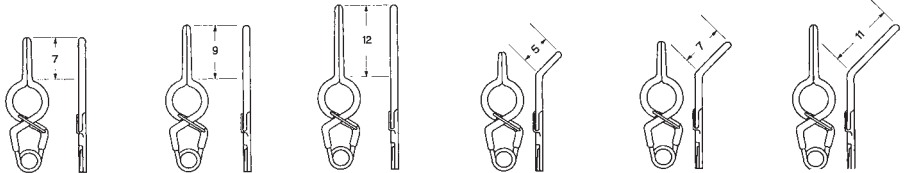

Cat. Nr.	41616-79	41616-91	41617-10	41617-65	41617-72	41617-78
	41616-79 T	41616-91 T	41617-10 T	41617-65 T	41617-72 T	41617-78 T
max. opening	7,9 mm	9,1 mm	10,3 mm	6,5 mm	7,2 mm	7,8 mm
Force	150 gms	150 gms	180 gms	150 gms	150 gms	180 gms

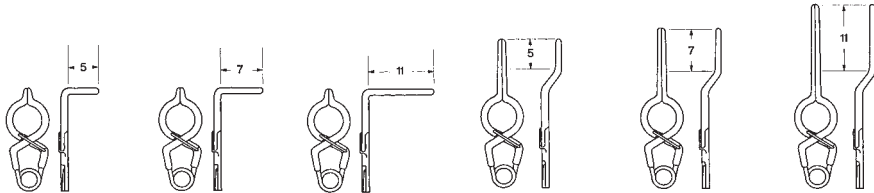

	41618-55	41618-56	41618-57	41618-79	41618-88	41619-00
	41618-55 T	41618-56 T	41618-57 T	41618-79 T	41618-88 T	41619-00 T
	5,5 mm	5,5 mm	5,5 mm	7,9 mm	8,8 mm	10,0 mm
	150 gms	150 gms	180 gms	150 gms	150 gms	180 gms

YASARGIL – Aneurysmen – Gefäß – Clips
 YASARGIL – Aneurysm – Vessel – Clips
 YASARGIL – Clips para aneurisma
 YASARGIL – Clips per aneurisma

aus hochwertigem Implantat-Stahl antimagnetisch
 in high quality Implant steel antimagnetic
 de acero inoxidable para implantes de alta calidad, antimagnético
 Prodotto in acciaio di alta qualità, antimagnetico

YASARGIL-STANDARD für permanenten Verschluss
 YASARGIL-STANDARD for permanent closure
 YASARGIL-STANDARD para cierre permanente
 YASARGIL-STANDARD con chiusura permanente

Standard

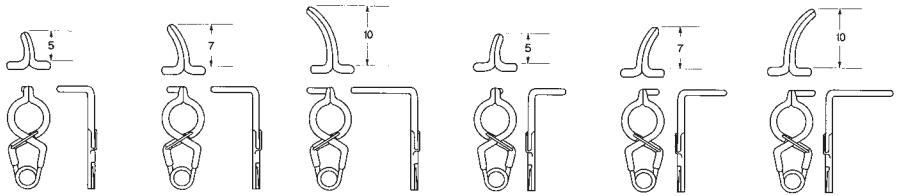

Cat. Nr.	41620-58	41620-59	41620-60	41620-61	41620-62	41620-63
max. opening	5,8 mm	5,8 mm	5,8 mm	5,8 mm	5,8 mm	5,8 mm
Force	150 gms	150 gms	150 gms	150 gms	150 gms	150 gms

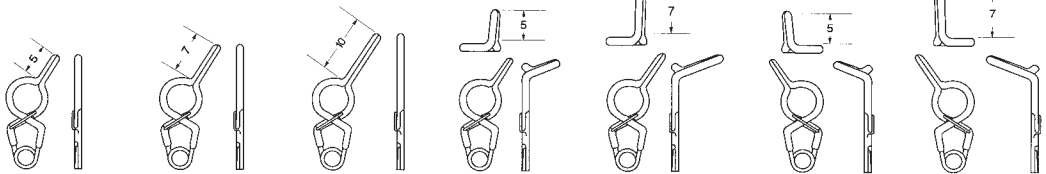

41620-70	41620-78	41620-88	41621-58	41621-62	41622-58	41622-62
41620-70 T	41620-78 T	41620-88 T	41621-58 T	41621-62 T	41622-58 T	41622-62 T
7,0 mm	7,8 mm	8,8 mm	5,8 mm	6,2 mm	5,8 mm	6,2 mm
150 gms	150 gms	150 gms	150 gms	150 gms	150 gms	150 gms

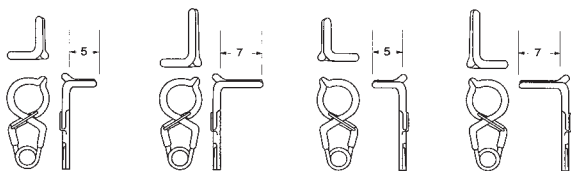

41623-56	41624-56	41625-56	41626-56
41623-56 T	41624-56 T	41625-56 T	41626-56 T
5,6 mm	5,6 mm	5,6 mm	5,6 mm
150 gms	150 gms	150 gms	150 gms

YASARGIL – Aneurysmen – Gefäß – Clips
 YASARGIL – Aneurysm – Vessel – Clips
 YASARGIL – Clips para aneurisma
 YASARGIL – Clips per aneurisma

aus hochwertigem Implantat-Stahl antimagnetisch
 in high quality Implant steel antimagnetic
 de acero inoxidable para implantes de alta calidad, antimagnético
 Prodotto in acciaio di alta qualità, antimagnetico

YASARGIL-STANDARD für permanenten Verschluss
 YASARGIL-STANDARD for permanent closure
 YASARGIL-STANDARD para cierre permanente
 YASARGIL-STANDARD con chiusura permanente

Mini



Cat. Nr.
 max. opening
 Force

41627-33
41627-33 T
 3,3 mm
 110 gms

41627-40
41627-40 T
 4,0 mm
 110 gms

41628-33
41628-33 T
 3,3 mm
 110 gms

41628-40
41628-40 T
 4,0 mm
 110 gms

41628-46
41628-46 T
 4,6 mm
 110 gms

41629-32
41629-32 T
 3,2 mm
 110 gms



41629-38
41629-38 T
 3,8 mm
 110 gms

41630-36
41630-36 T
 3,6 mm
 110 gms

41630-38
41630-38 T
 3,8 mm
 110 gms

41631-36
41631-36 T
 3,6 mm
 110 gms

41631-40
41631-40 T
 4,0 mm
 110 gms

41631-44
41631-44 T
 4,4 mm
 110 gms

41632-36
41632-36 T
 3,6 mm
 110 gms

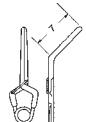
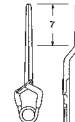
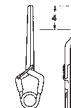
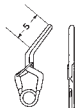

41633-35
41633-35 T
 3,5 mm
 110 gms

41633-40
41633-40 T
 4,0 mm
 110 gms

41634-35
41634-35 T
 3,5 mm
 130 gms

41634-60
41634-60 T
 6,0 mm
 130 gms

41634-70
41634-70 T
 7,0 mm
 130 gms

41635-57
41635-57 T
 5,7 mm
 130 gms

41636-45
41636-45 T
 4,5 mm
 130 gms

YASARGIL – Aneurysmen – Gefäß – Clips
YASARGIL – Aneurysm – Vessel – Clips
YASARGIL – Clips para aneurisma
YASARGIL – Clips per aneurisma

aus hochwertigem Implantat-Stahl antimagnetisch
in high quality Implant steel antimagnetic
de acero inoxidable para implantes de alta calidad, antimagnético
Prodotto in acciaio di alta qualità, antimagnetico

YASARGIL-STANDARD für temporären Verschluss
YASARGIL-STANDARD for temporary closure
YASARGIL-STANDARD para cierre temporal
YASARGIL-STANDARD con chiusura temporanea

Mini



Cat. Nr.	41637-33 41637-33 T	41637-40 41637-40 T	41638-38 41638-38 T	41638-46 41638-46 T	41639-44 41639-44 T	41640-40 41640-40 T
max. opening	3,3 mm	4,0 mm	3,8 mm	4,6 mm	4,4 mm	4,0 mm
Force	50 gms	50 gms	50 gms	70 gms	70 gms	70 gms

Anlegezange mit Rundgriff – FLEXIBEL – mit und ohne drehbarem Maulteil
 Applying forceps with round shaft – FLEXIBLE – with and without rotation
 Pinzas de aplicación con mango redondo – FLEXIBLE – con y sin rotación
 Posa clips con manico rotondo guaina flessibile con sistema rotante ed non rotante

Länge		
Length		
Largo		
Lunghezza	MINI	STANDARD
70 mm	41641-07	41643-07
90 mm	41641-09	41643-09
110 mm	41641-11	41643-11

nicht drehbar
 non rotating
 no giratorio
 non rotante

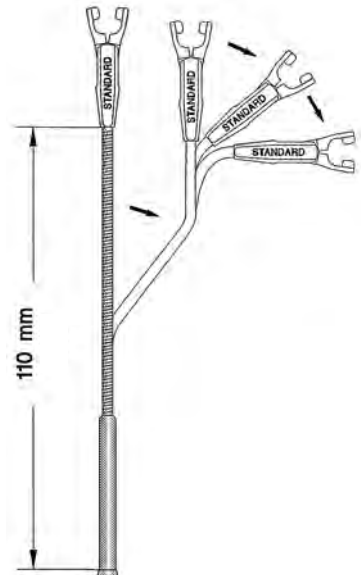
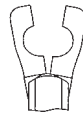

Länge		
Length		
Largo		
Lunghezza	MINI	STANDARD
70 mm	41642-07	41644-07
90 mm	41642-09	41644-09
110 mm	41642-11	41644-11

drehbar
 rotating
 giratorio
 rotante

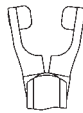

drehbar
 rotating
 giratorio
 rotante

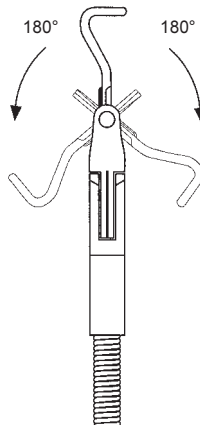

Beispiel für Drehmechanismus
 Example for rotation
 Ejemplo del mecanismo giratorio
 Esempio della rotazione

Clips drehbar im Maul
 Clips rotabile in jaw
 Clips giratorios en la boca
 Clips rotabile nel morso

41641-07 - 41644-11

Anlegezange mit Rundgriff – starr – mit und ohne drehbarem Maulteil
 Applying forceps with round shaft – rigid – with and without rotation
 Pinzas de aplicación con mango redondo – rígido – con y sin rotación
 Posa clips con manico rotondo guaina rigida con sistema rotante ed non rotante

Länge		
Length		
Largo		
Lunghezza	MINI	STANDARD
70 mm	41645-07	41647-07
90 mm	41645-09	41647-09
110 mm	41645-11	41647-11

nicht drehbar
 non rotating
 no giratorio
 non rotante

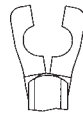

Länge		
Length		
Largo		
Lunghezza	MINI	STANDARD
70 mm	41646-07	41648-07
90 mm	41646-09	41648-09
110 mm	41646-11	41648-11

drehbar
 rotating
 giratorio
 rotante

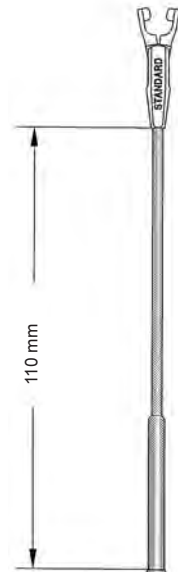
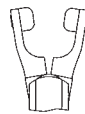

drehbar
 rotating
 giratorio
 rotante

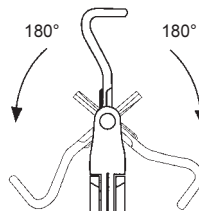

Beispiel für Drehmechanismus
 Example for rotation
 Ejemplo del mecanismo giratorio
 Esempio della rotazione

Clips drehbar im Maul
 Clips rotabile in jaw
 Clips giratorios en la boca
 Clips rotabile nel morso

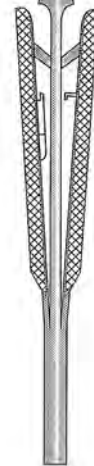

41645-07 - 41648-11

Anlegezange mit Rundgriff – starr – mit und ohne drehbarem Maulteil
 Applying forceps with round shaft – rigid – with and without rotation
 Pinzas de aplicación con mango redondo – rigido – con y sin rotación
 Posa clips con manico rotondo guaina rigida con sistema rotante ed non rotante

Länge Length Largo Lunghezza	MINI	STANDARD
70 mm	41649-07	41651-07
90 mm	41649-09	41651-09
110 mm	41649-11	41651-11

nicht drehbar
 non rotating
 no giratorio
 non rotante

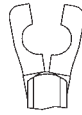

Länge Length Largo Lunghezza	MINI	STANDARD
70 mm	41650-07	41652-07
90 mm	41650-09	41652-09
110 mm	41650-11	41652-11

drehbar
 rotating
 giratorio
 rotante

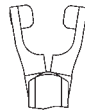

drehbar
 rotating
 giratorio
 rotante

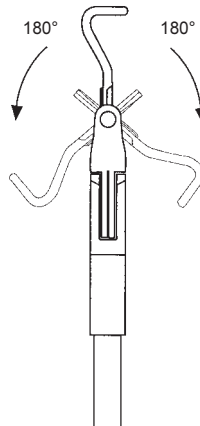

Beispiel für Drehmechanismus
 Example for rotation
 Ejemplo del mecanismo giratorio
 Esempio della rotazione

Clips drehbar im Maul
 Clips rotabile in jaw
 Clips giratorios en la boca
 Clips rotabile nel morso

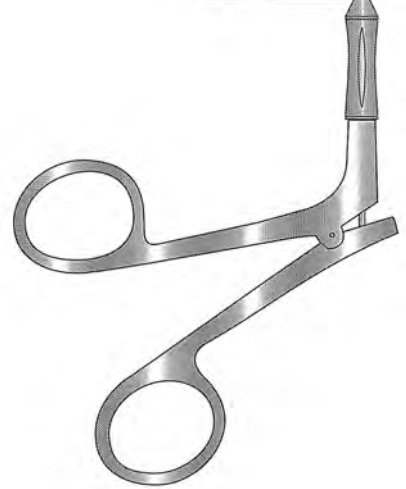
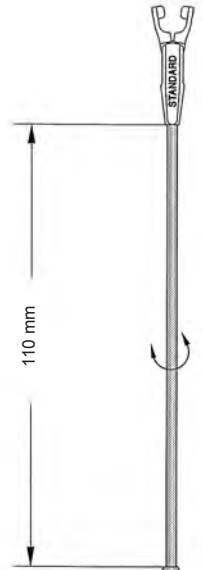

41649-07 - 41652-11

Anlegezange – mit und ohne drehbarem Maulteil
 Applying Forceps – with and without rotation
 Pinzas de aplicación, con y sin rotación
 Pinza posa clips, con ed senza rotazione

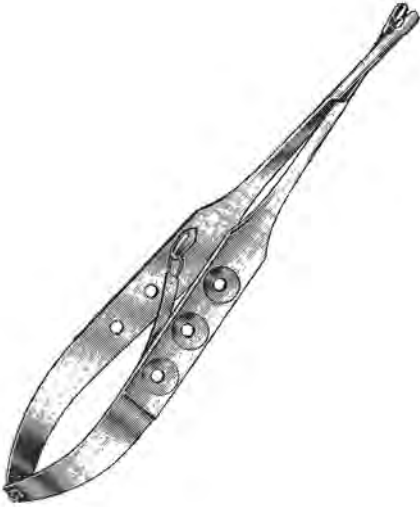

MINI	41653-18	
STANDARD	41654-18	
MINI	41655-18	drehbar / rotating giratorio / rotante
STANDARD	41656-18	drehbar / rotating giratorio / rotante

Anlegezange gerade, mit Sperre, Länge 18 cm, 7"
 Applying Forceps straight, with ratchet, Length 18 cm, 7"
 Pinza de aplicación, con cremallera, 18 cm, 7"
 Posa clips, retta con bloccaggio lunghezza 18 cm, 7"





Länge			
Length			
Largo			
Lunghezza	17 cm, 6 ³ / ₄ "	21 cm, 8 ¹ / ₄ "	23 cm, 9"
MINI	41657-17	41657-21	41657-23
STANDARD	41658-17	41658-21	41658-23
MINI	41659-17	41659-21	41659-23
	drehbar / rotating / giratorio / rotante		
STANDARD	41660-17	41660-21	41660-23
	drehbar / rotating / giratorio / rotante		

Clips drehbar im Maul
 Clips rotabile in jaw
 Clips giratorios en la boca
 Clips rotabile nel morso

Anlegezange bayonett, mit Sperre
 Applying Forceps bayonett, with ratchet
 Pinza de aplicación bayoneta, con cremallera
 Posa clips a baionetta con bloccaggio

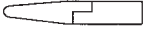
Gefäßclips nach BIEMER
 BIEMER Vessel Clips
 Clips para vasos de BIEMER
 Clips per vasi secondo BIEMER

	Maulöffnung Opening	Maullänge Length of jaws	Schließkraft Closing Force
 41661-40	4,0 mm	6,0 mm	Fuerza del cierre Forza di chiusura 30 - 40 g (0,29 - 0,39 N)
 41661-50	5,0 mm	9,0 mm	30 - 40 g (0,29 - 0,39 N)
 41662-50	5,0 mm	9,0 mm	20 - 25 g (0,20 - 0,25 N)

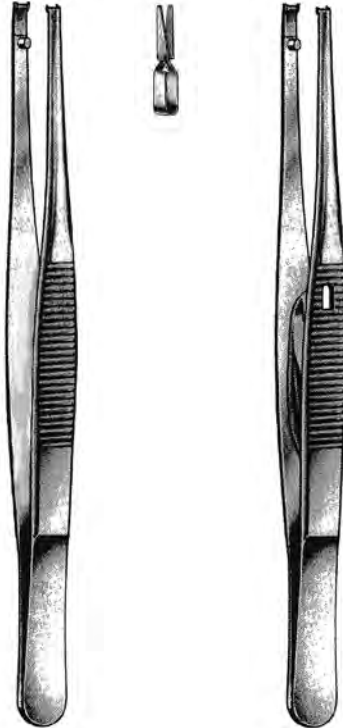

für temporären Gebrauch

gekennzeichnet durch gelb eingefärbte Federenden für
 Gefäße mit einem Durchmesser 0,5 - 2,0 mm

Maulinnenflächen schräg gerieft für schonendes, sicheres
 Festhalten der Gefäße

Der fest eingestellte Schließdruck gewährt risikofreie An-
 wendung

for temporary occlusion

(identified by yellow coloured spring ends) for vessel diam.
 0,5 - 2,0 mm

Blade gripping surface with oblique serrations for save but
 careful gripping of vessels

No risk due to rigidly fixed pressure measure

para uso temporal

clips marcados con baño dorado en los resortes, para
 vasos con un diámetro de 0,5 - 2,0 mm

El interior de las quijadas viene con estrias finas para un
 agarre seguro y cuidadoso de los vasos

Debido a la calibración exacta de la fuerza de cierre se
 ofrece una aplicación sin riesgo

per chiusura temporanea

per vasi con Diametro 0,5 - 2,0 mm

La chiusura regolata garantisce nessun rischio

BIEMER
 41663-01

Anlegepinzette ohne Schloß,
 für Mikro-Gefäßclips
 41661-40 - 41662-50
 und
 Approximatoren
 41667-30 - 41670-50
 und
 41672-01 - 41672-04

Applying forceps without lock.
 for vessel clips
 41661-40 - 41662-50
 and
 Aproximators
 41667-30 - 41670-50
 and
 41672-01 - 41672-04

BIEMER
 41663-02

Anlegepinzette mit Schloß,
 für Mikro-Gefäßclips
 41661-40 - 41662-50
 und
 Approximatoren
 41667-30 - 41670-50
 und
 41672-01 - 41672-04

Applying forceps with lock.
 for vessel clips
 41661-40 - 41662-50
 and
 Aproximators
 41667-30 - 41670-50
 and
 41672-01 - 41672-04

Gefäßclips nach MEHDORN
MEHDORN Vessel Clips
Clips para vasos de MEHDORN
Clips secondo MEHDORN

für temporären Gebrauch

gekennzeichnet durch gelb eingefärbte Federenden für Gefäße mit einem Durchmesser 0,5 - 1,5 mm

Maulinnenflächen schräg gerieft für schonendes, sicheres Festhalten der Gefäße

Der fest eingestellte Schließdruck gewährt risikofreie Anwendung

for temporary occlusion

(identified by yellow coloured spring ends) for vessel diam. 0,5 - 1,5 mm

Blade gripping surface with oblique serrations for save but careful gripping of vessels

No risk due to rigidly fixed pressure measure

para uso temporal

clips marcados con baño dorado en los resortes, para vasos con un diámetro de 0.5 - 1.5 mm

El interior de las quijadas viene con estrias finas para un agarre seguro y cuidadoso de los vasos

Debido a la calibración exacta de la fuerza de cierre se ofrece una aplicación sin riesgo

per chiusura temporanea





per vasi con Diametro 0,5 - 1,5 mm

La chiusura regolata garantisce nessun rischio

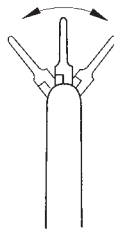
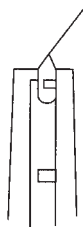

Beispiele für die variable Position des Clips
Ejemplo para la variedad de la aplicación del clip
Esempio: posizioni variabili delle clips



		Maullänge Length of jaws Largo de la boca Lunghezza del morso	Schließkraft Closing Force Fuerza del cierre Forza di chiusura	MEHDORN 41666-00
	41664-10	4 x 1,0 mm	10 - 15 g (0,10 - 0,15 N)	Anlegepinzette für Mikro-Gefäßclips 41664-10 - 41665-14
	41664-14	4 x 1,4 mm	15 - 20 g (0,15 - 0,20 N)	Applying Forceps for vessel clips 41664-10 - 41665-14
	41665-10	6 x 1,0 mm	10 - 15 g (0,10 - 0,15 N)	Pinza applicadora para micro-vasos 41664-10 - 41665-14
	41665-14	6 x 1,4 mm	15 - 20 g (0,15 - 0,20 N)	Pinza posa clips per microvasi 41664-10 - 41665-14

Approximatoren nach Biemer-Müller
 Approximators Biemer-Müller
 Aproximadores de Biemer-Müller
 Approssimatore secondo Biemer-Müller

für temporären Gebrauch

gekennzeichnet durch gelb eingefärbte Federenden für Gefäße mit einem Durchmesser 0,5 - 2,0 mm
 Maulinnenflächen schräg gerieft für schonendes, sicheres Festhalten der Gefäße
 Der fest eingestellte Schließdruck gewährt risikofreie Anwendung

for temporary occlusion

(identified by yellow coloured spring ends) for vessel diam. 0,5 - 2,0 mm
 Blade gripping surface with oblique serrations for save but careful gripping of vessels
 No risk due to rigidly fixed pressure measure

para uso temporal

clips marcados con baño dorado en los resortes, para vasos con un diámetro de 0,5 - 2,0 mm
 El interior de las quijadas viene con estrias finas para un agarre seguro y cuidadoso de los vasos
 Debido a la calibración exacta de la fuerza de cierre se ofrece una aplicación sin riesgo

per chiusura temporanea

per vasi con Diametro 0,5 - 2,0 mm
 La chiusura regolata garantisce nessun rischio

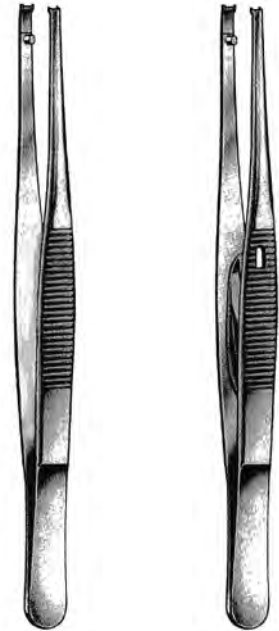

	Maulöffnung Opening	Maullänge Length of jaws	Schließkraft Closing Force
	Apertura de la boca	Largo de la boca	Fuerza del cierre
	Apertura del morso	Lunghezza del morso	Forza di chiusura
	3,0 mm	4,5 mm	30 - 40 g (0,29 - 0,39 N)
	5,0 mm	9,0 mm	30 - 40 g (0,29 - 0,39 N)
	5,0 mm	9,0 mm	30 - 40 g (0,20 - 0,25 N)
	5,0 mm	9,0 mm	30 - 40 g (0,20 - 0,25 N)
	5,0 mm	9,0 mm	30 - 40 g (0,20 - 0,25 N)

BIEMER
41663-01

BIEMER
41663-02

Anlegepinzette ohne
Schloß,
für Mikro-Gefäßclips
41661-40 - 41662-50
und
Approximatoren
41667-30 - 41670-50
und
41672-01 - 41672-04

Anlegepinzette mit
Schloß,
für Mikro-Gefäßclips
41661-40 - 41662-50
und
Approximatoren
41667-30 - 41670-50
und
41672-01 - 41672-04

Applying forceps
without lock.
for vessel clips
41661-40 - 41662-50
and
Approximators
41667-30 - 41670-50
and
41672-01 - 41672-04

Applying forceps
with lock.
for vessel clips
41661-40 - 41662-50
and
Approximators
41667-30 - 41670-50
and
41672-01 - 41672-04

Approximatoren nach Müller
Müller Approximators
Aproximadores de Müller
Approssimatore secondo Müller

für temporären Gebrauch

gekennzeichnet durch gelb eingefärbte Federenden für Gefäße mit einem Durchmesser 0,5 - 2,0 mm
Maulinnenflächen schräg gerieft für schonendes, sicheres Festhalten der Gefäße
Der fest eingestellte Schließdruck gewährt risikofreie Anwendung

for temporary occlusion

(identified by yellow coloured spring ends) for vessel diam. 0,5 - 2,0 mm
Blade gripping surface with oblique serrations for save but careful gripping of vessels
No risk due to rigidly fixed pressure measure

para uso temporal

clips marcados con baño dorado en los resortes, para vasos con un diámetro de 0,5 - 2,0 mm
El interior de las quijadas viene con estrias finas para un agarre seguro y cuidadoso de los vasos
Debido a la calibración exacta de la fuerza de cierre se ofrece una aplicación sin riesgo

per chiusura temporanea

per vasi con Diametro 0,5 - 2,0 mm
La chiusura regolata garantisce nessun rischio

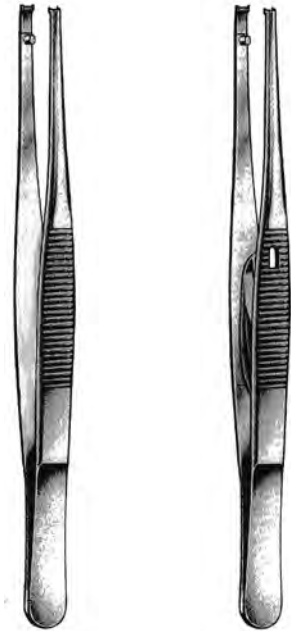

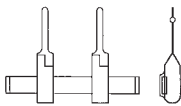
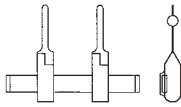
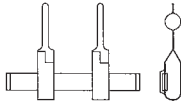
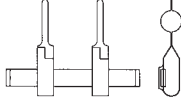
	Ø Diameter	Schließkraft Closing Force Fuerza del cierre Forza di chiusura	BIEMER 41663-01	BIEMER 41663-02
	1,0 mm	25 - 30 g (0,25 - 0,29 N)	Anlegepinzette ohne Schloß, für Mikro-Gefäßclips 41661-40 - 41662-50 und Approximatoren 41667-30 - 41670-50 und 41672-01 - 41672-04	Anlegepinzette mit Schloß, für Mikro-Gefäßclips 41661-40 - 41662-50 und Approximatoren 41667-30 - 41670-50 und 41672-01 - 41672-04
	2,0 mm	25 - 30 g (0,25 - 0,29 N)	Applying forceps without lock. for vessel clips 41661-40 - 41662-50 and Aproximators 41667-30 - 41670-50 and 41672-01 - 41672-04	Applying forceps with lock. for vessel clips 41661-40 - 41662-50 and Aproximators 41667-30 - 41670-50 and 41672-01 - 41672-04
	3,0 mm	25 - 30 g (0,25 - 0,29 N)		
	4,0 mm	25 - 30 g (0,25 - 0,29 N)		

Gefäßclips nach Müller
Müller Vessel Clips
Clips para vasos de Müller
Clip secondo Müller

für temporären Gebrauch

Maulinnenflächen pyramidenförmig
für schonendes, sicheres Festhalten
der Gefäße

Der fest eingestellte Schließdruck
gewährt risikofreie Anwendung

for temporary occlusion

Blade gripping surface with pyramid-
like impressions for save but careful
gripping of vessels

No risk due to rigidly fixed pressure
measure

para uso temporal

El interior de las quijadas viene en
forma de pirámide para un agarre
seguro y cuidadoso de los vasos.

Debido a la calibración exacta de
la fuerza de cierre se ofrece una
aplicación sin riesgo.

per uso temporaneo

Morso interno con forma piramidale
per garantire una chiusura sicura del
vaso

Schließkraft
Closing Force
Fuerza del cierre
Forza di chiusura

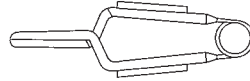

41674-50 50 g

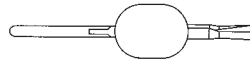

41674-80 80 g

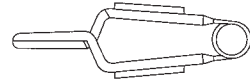

41675-50 50 g

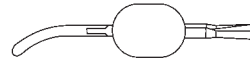

41675-80 80 g

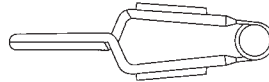

41676-50 50 g

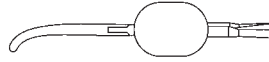

41676-80 80 g



41677-50 50 g

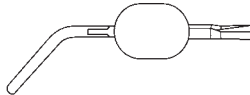

41677-80 80 g

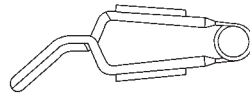

41678-50 50 g

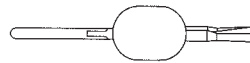

41678-80 80 g

Approximator nach Biemer
Biemer Approximator
Aproximadores de Biemer
Approssimatore secondo Biemer

für Mikro-Gefäßanastomosen im oberflächlichem Bereich

Maulinnenflächen schräg gerieft für schonendes, sicheres Festhalten der Gefäße

Der fest eingestellte Schließdruck gewährt risikofreie Anwendung

Der Abstand zwischen den Clips ist durch einfaches Verschieben einzustellen und wird durch Verkanten fixiert

for micro vessel anastomosis in the superficial range

Blade gripping surface with oblique serrations for save but careful gripping of vessels

No risk due to rigidly fixed pressure measure

Adjustable distance between the clips and automatic fixation by tilting

para micro-anastomosis en la superficie

El interior de la quijada viene con estrias finas para un agarre seguro y cuidadoso de los vasos.

Debido a la calibración exacta de la fuerza de cierre se ofrece una aplicación sin riesgo.

El espacio entre los clips se logra fácilmente por el desplazamiento.

per micro vasi anastomosi sulla parte della superficie

Parte interna del morso è leggermente striata obliqua per ottenere la presa sulla superficie del vaso.

La chiusura regolata garantisce nessun rischio.

Lo scorrimento delle due clips viene regolato con semplice movimento che consente una chiusura ottimale.



BIEMER
41680-00

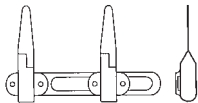

41679-25 25 - 30 g
(0,25 - 0,29 N)

Schließkraft
Closing Force
Fuerza de cierre
Forza di chiusura

Anlegepinzette für
Gefäß-Approximator
nach BIEMER

Applying forceps for
BIEMER vessel
approximator

Pinza aplicadora
para aproximadores
de BIEMER

Pinza posa clips per
vasi approssimatori
secondo BIEMER

Mikro-Gefäßclips
Micro Vessel Clips
Micro Clips vasculares
Micro Clips vascolari



BIEMER
41679-00

Nerv-Approximator komplett mit Schlüssel 41690-01
Approximator for nerves complete with key 41690-01
Aproximador para nervios, completo con llave 41690-01
Approssimatore per nervi completo di chiave 41690-01

41679-01
Nadeln allein (Paar)
Needle only (pair)
Agujas sueltas (par)
Aghi soli (paio)



BIEMER
41690-00

Approximator mit einstellbarem Clip-Abstand und Druck,
komplett mit Schlüssel 41690-01

Approximator with adjustable clip distance and pressure,
complete with key 41690-01

Aproximador con distancia de clip y presión ajustable,
completo con llave 41690-01

Approssimatore con distanza per clip e pressione regolabile,
completo di chiave 41690-01



41690-01
Ersatzschlüssel
für Approximator 41679-00 + 41690-00

Replacement key
for approximator 41679-00 + 41690-00

Llave de repuesto
para el aproximador 41679-00 + 41690-00

Chiave di ricambio
per approssimatore 41679-00 + 41690-00

Sterilisations- und Lagerungscontainer
Sterilisation and Utility Tray Storage
Contenedor para esterilizacion y almacenaje

Container dotato di alloggi interni per la conservazione e la sterilizzazione degli strumenti

41700-01
528 x 254 x 40 mm

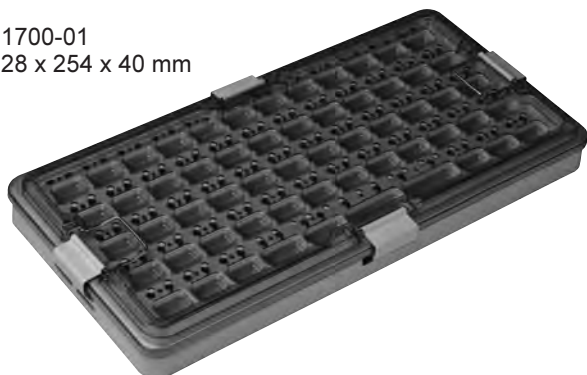

Clip Lagertray für 58 Y-Aneurysmenclips,
Kunststoff, dampfsterilisierbar bis 3 bar
(143° C / 289° F)

Storage tray for 58 Y-Aneurysm-Clips, with lid
made out of PPSU

Cesta de plástico para almacenaje de
58 Y-clips de aneurisma

Contenitore di plastica con 58 alloggi per clip
per aneurisma. Resistente in autoclave fino a
3 bar (143° C / 289° F)

41700-02
528 x 254 x 40 mm

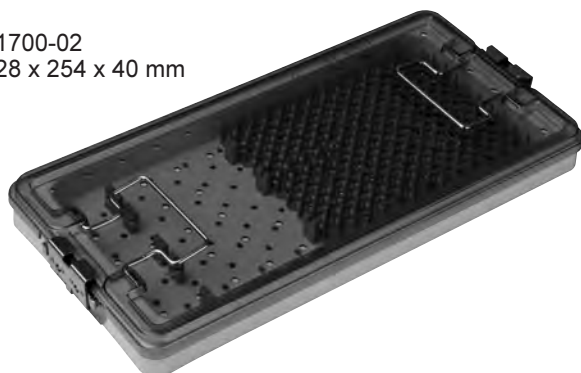

Lagertray für Clipanlegezangen und Instru-
mente, Kunststoff, dampfsterilisierbar bis
3 bar (143° C / 289° F).

Storage tray for clip applicators and instruments,
stacking system, made out of PPSU, for steam
sterilisation up to 3 bar (143° C / 289° F)

Cesta de plástico para almacenaje de pinzas
aplicadoras y instrumentos, para esteriliza-
cion de vapor hasta 3 bar (143° C / 289° F).

Contenitore di plastica per pinza applicatore
clips e strumentario. Resistente in autoclave
3 bar (143° C / 289° F)

Sterilisations- und Lagerungscontainer
Sterilisation and Utility Tray Storage
Contenedor para esterilizaci3n y almacenaje
Container dotato di alloggi interni per la conservazione e la sterilizzazione degli instrumenti

41700-03
528 x 254 x 40 mm

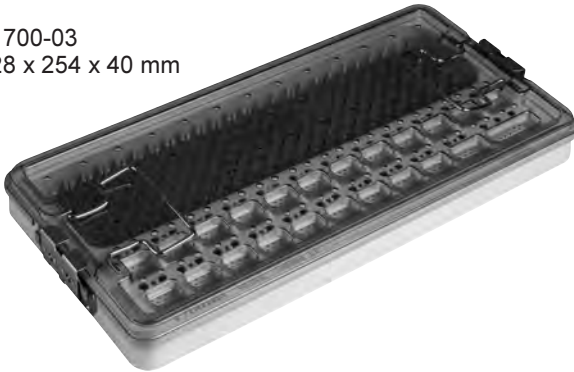

Lagertray für 23 Y-Aneurysmenclips und Clip-
anlegezangen Kunststoff mit Deckel, dampf-
sterilisierbar bis 3 bar (143° C / 289° F)

Storage tray for 23 Y-Aneurysmen-Clips and
clip applicators, stacking system, with lid made
out of PPSU, for steam sterilisation up to 3 bar
(143° C / 289° F)

Cesta de plástico con tapa para almacenaje de
23 Y-clips de aneurisma y pinzas aplicadoraa,
para esterilizaci3n de vapor hasta 3 bar
(143° C / 289° F)

Contenitore di plastica dotato di alloggio per
23 clips per aneurisma e pinza posa clips con
coperchio. Resistente in autovlave 3 bar
(143° C / 289° F)



41700-04
150 x 95 x 13 mm

mit 18 Vertiefungen
space for 18 Clips
con espacio para 18 clips
con cavita per 18 clips



41700-05
210 x 125 x 17 mm

mit 42 Vertiefungen
space for 42 Clips
con espacio para 42 clips
con cavita per 42 clips

“Neue Form” NS
“New Style” NS
“Nueva Forma” NS
“Nuove Forme” NS

ACLAND Mikro-Gefäßclips
 ACLAND Micro Vessel Clips
 ACLAND Micro Clips vasculares
 ACLAND Micro Clips vascolari

Einzelklemmen
 Single Clamps
 Single clamp
 Pinza singola



A		V
41710-08	8 mm	41711-08
41710-11	11 mm	41711-11
41710-17	17 mm	41711-17



A		V
41718-25	25 mm	41719-25
41718-36	36 mm	41719-36

Doppelklemme mit Rahmen
 Double Clamps with frame
 Clamp doble con marco
 Pinza doppia con telaio

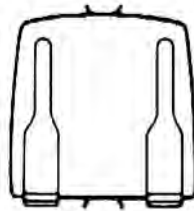

A		V
41714-08	8 mm	41715-08
41714-11	11 mm	41715-11
41714-17	17 mm	41715-17

Approximator ohne Rahmen
 Approximator without frame
 Aproximador sin marco
 Approssimatore senza telaio

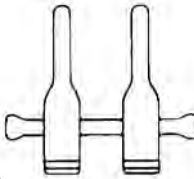

A		V
41712-08	8 mm	41713-08
41712-11	11 mm	41713-11
41712-17	17 mm	41713-17

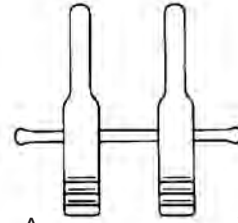

A		V
41720-25	25 mm	41721-25
41720-36	36 mm	41721-36

Approximator mit Rahmen
 Approximator with frame
 Aproximador con marco
 Approssimatore con telaio

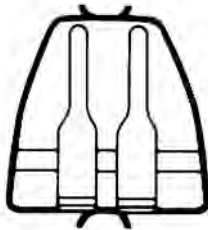

A		V
41716-08	8 mm	41717-08
41716-11	11 mm	41717-11
41716-17	17 mm	41717-17

A = Arterie/Artery
CURVED JAW



V = Vene/Vein
STRAIGHT JAW



ACLAND Mikro-Gefäßclips
 ACLAND Micro Vessel Clips
 ACLAND Micro Clips vasculares
 ACLAND Micro Clips vascolari

"Alte Form" OS
 "Classic Style" OS
 "Forma antigua" OS
 "Vecchia tipologia" OS

Einzelklemmen
 Single Clamps
 Single clamp
 Pinza singola

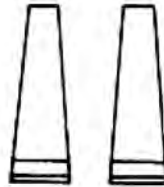

A		V
41722-08	8 mm	41723-08
41722-11	11 mm	41723-11
41722-14	14 mm	41723-14
41722-17	17 mm	41723-17
41722-23	23 mm	41723-23

Doppelklemme mit Rahmen
 Double Clamps with frame
 Clamp doble con marco
 Pinza doppia con telaio

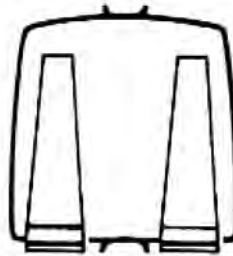

A		V
41726-08	8 mm	41727-08
41726-11	11 mm	41727-11
41726-14	14 mm	41727-14
41726-17	17 mm	41727-17
41726-23	23 mm	41727-23

A = Arterie/Artery
CURVED JAW



V = Vene/Vein
STRAIGHT JAW



"Alte Form" OS
 "Classic Style" OS
 "Forma antigua" OS
 "Vecchia tipologia" OS

ACLAND Mikro-Gefäßclips
 ACLAND Micro Vessel Clips
 ACLAND Micro Clips vasculares
 ACLAND Micro Clips vascolari

Approximator ohne Rahmen
 Approximator without frame
 Aproximador sin marco
 Approssimatore senza telaio

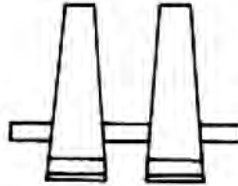

A		V	
41724-08	8 mm	41725-08	
41724-11	11 mm	41725-11	
41724-14	14 mm	41725-14	
41724-17	17 mm	41725-17	
41724-23	23 mm	41725-23	

Approximator mit Rahmen
 Approximator with frame
 Aproximador con marco
 Approssimatore con telaio

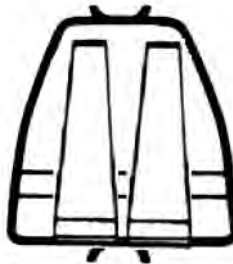

A		V	
41728-08	8 mm	41729-08	
41728-11	11 mm	41729-11	
41728-14	14 mm	41729-14	
41728-17	17 mm	41729-17	
41728-23	23 mm	41729-23	

A = Arterie/Artery
CURVED JAW



V = Vene/Vein
STRAIGHT JAW



Clip-Anlegepinzetten für ACLAND-Clips
Clip Applying Forceps for ACLAND clips
Pinzas aplicadora para clips ACLAND
Pinze per applicare clips di ACLAND

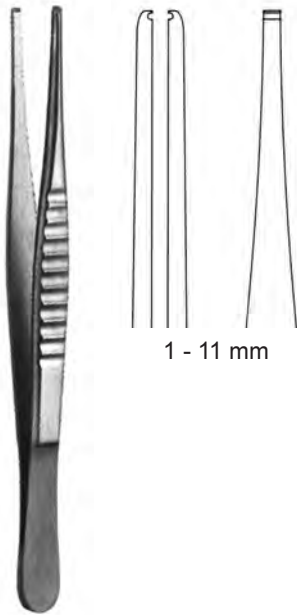

1 - 11 mm

ACLAND
41730-15
14,5 cm 5 ³/₄"

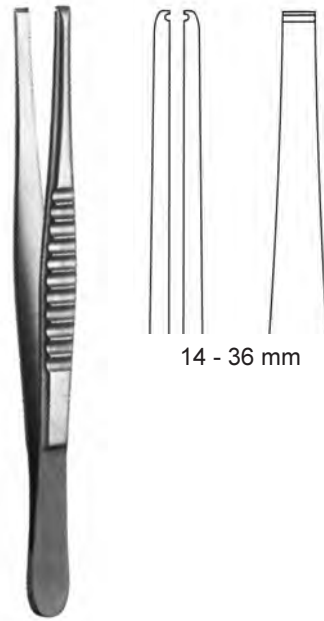

14 - 36 mm

ACLAND
41731-15
14,5 cm 5 ³/₄"

Clipanlegezangen für die offene Chirurgie 25° aufgebogen
Clip Appliers for open Surgery 25° upcurved
Pinza aplicadora de clips para cirugía abierta con ángulo de 25°
Pinza applicatore clips per chirurgia aperta, curva in alto 25°



15 cm, 6"

Horizon

61460-15 Small gelb / yellow / jaune/ amarillo/ giallo
61461-15 Medium blau / blue / bleu / azul / blu

SLS Clips

61464-15 Micro weiss / white / blanc / blanco / bianco
61465-15 Small gelb / yellow / jaune/ amarillo/ giallo
61466-15 Small medium lila / lilac / lilas / lila / lilla
61467-15 Medium blau / blue / bleu / azul / blu

Ethicon

61470-15 Small blau / blue / bleu / azul / blu
61471-15 Medium weiss / white / blanc / blanco / bianco

Pilling

61481-15 Small gelb / yellow / jaune / amarillo / giallo
61482-15 Medium blau / blue / bleu / azul / blu

Horizon

61460-19 Small gelb / yellow / jaune / amarillo / giallo
61461-19 Medium blau / blue / bleu / azul / blu
61462-19 Medium Large grün / green / verde / verde
61463-19 Large orange / naranja / arancione

SLS Clips

61464-19 Micro weiss / white / blanc / blanco / bianco
61465-19 Small gelb / yellow/ jaune / amarillo / giallo
61466-19 Small medium lila / lilac / lilas / lila / lilla
61467-19 Medium blau / blue / bleu / azul / blu
61468-19 Medium Large grün / green / verde / verde
61469-19 Large orange / naranja / arancione

Ethicon

61470-19 Small blau / blue / bleu / azul / blu
61471-19 Medium weiss / white / blanc / blanco / bianco
61472-19 Medium Large grün / green / verde / verde
61473-19 Large gelb / yellow / jaune / amarillo / giallo

Pilling

61481-19 Small gelb / yellow / jaune / amarillo / giallo
61482-19 Medium blau / blue / bleu / azul / blu
61484-19 Medium Large grün / green / verde / verde
61483-19 Large orange / naranja / arancione



19 cm, 7 1/2"

Clipanlegezangen für die offene Chirurgie 25° aufgebogen
Clip Applicators for open Surgery 25° upcurved
Pinza aplicadora de clips para cirugía abierta con ángulo de 25°
Pinza applicatore clips per chirurgia aperta, curva in alto 25°

Horizon

61461-28 Medium blau / blue / bleu / azul / blu
61462-28 Medium Large grün / green / verde / verde
61463-28 Large orange / naranja / arancione

SLS Clips

61464-28 Micro weiss / white / blanco / bianco
61465-28 Small gelb / yellow / jaune / amarillo / giallo
61466-28 Small medium lila / lilac / lilas / lila / lilla
61467-28 Medium blau / blue / bleu / azul / blu
61468-28 Medium Large grün / green / verde / verde
61469-28 Large orange / naranja / arancione

Ethicon

61471-28 Medium weiss / white / blanco / bianco
61472-28 Medium Large grün / green / verde / verde
61473-28 Large gelb / yellow / jaune / amarillo / giallo

Pilling

61482-28 Medium blau / blue / bleu / azul / blu
61484-28 Medium Large grün / green / verde / verde
61483-28 Large orange / naranja / arancione



28 cm, 11"

Reda Instrumente GmbH
Gänsäcker 34 - P.O. Box 131
D-78532 Tuttlingen

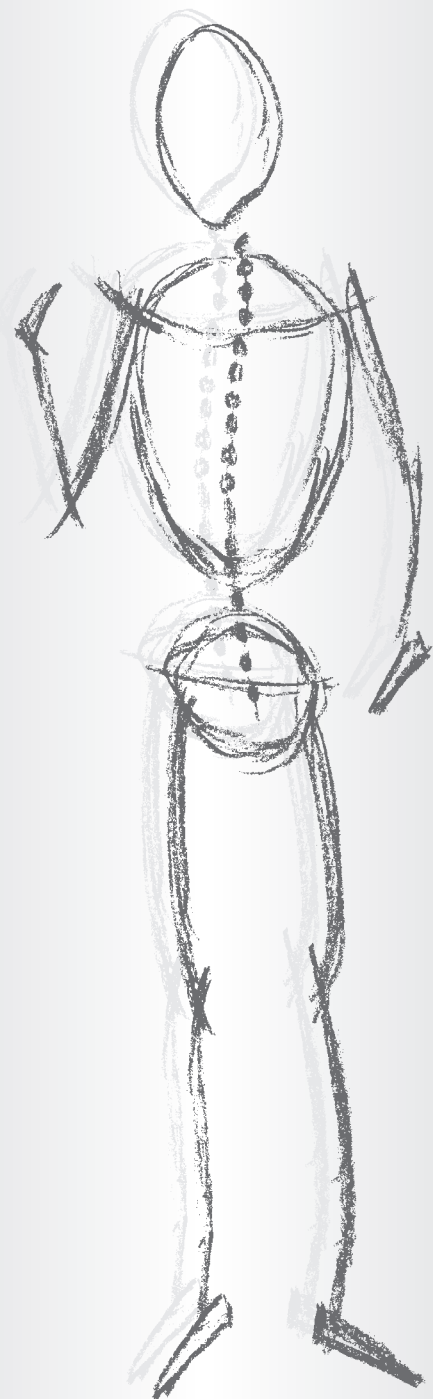

BOHRAPPARATE

BONE HAND DRILLS

PERFORADORES DE MANO

PERFORATORI A MANO



www.Reda-Instrumente.de

Bohrapparate
Bone Hand Drills
Perforadores de mano
Perforatori a mano

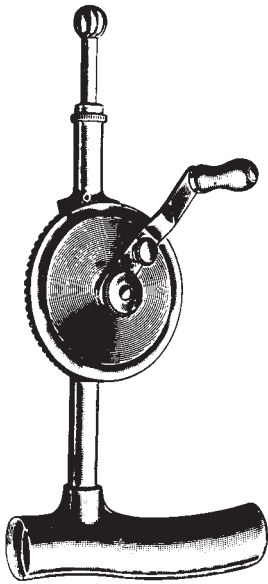

STILLE
34210-20 20 cm, 8"
compl. incl. 34212-25 - 34214-16



34212-25
2,5 mm



34212-30
3,0 mm



34212-35
3,5 mm



34212-40
4,0 mm



34214-05
10 mm



34214-08
5 mm



34214-10
8 mm



34214-12
12 mm



34214-16
16 mm



34216-10
1,0 mm



34216-15
1,5 mm



34216-20
2,0 mm

Bohrapparate
Bone Hand Drills
Perforadores de mano
Perforatori a mano



STILLE-SHERMAN
34220-24 24 cm, 9 1/2"
compl. incl. 34222-25 - 34222-35



34222-25
2,5 mm



34222-30
3,0 mm



34222-35
3,5 mm



MOORE
34230-28 28 cm, 11"
compl. incl. 34232-00



34232-00

Bohrapparate
 Bone Hand Drills
 Perforadores de mano
 Perforatori a mano



34241-00
 Griff allein
 Handle only
 Mango solo
 Manico solo

HUDSON
 34240-27
 27 cm, 10 1/2"
 compl. incl.
 34242-09, -14, -16, -22,
 34246-00



34242-09
 9 mm



34242-14
 14 mm



34242-16
 16 mm



34242-22
 22 mm



34246-00

Verlängerungsstück
 Extension piece
 Pieza alargadera
 Giunto di prolungamento



ø 2 mm
 34243-02



CUSHING
 34244-10
 34244-14
 34244-16



ERRICO
 34244-17
 ø 16 mm



MC KENZIE
 34248-00
 ø 13 mm

Bohrapparate
 Bone Hand Drills
 Perforadores de mano
 Perforatori a mano

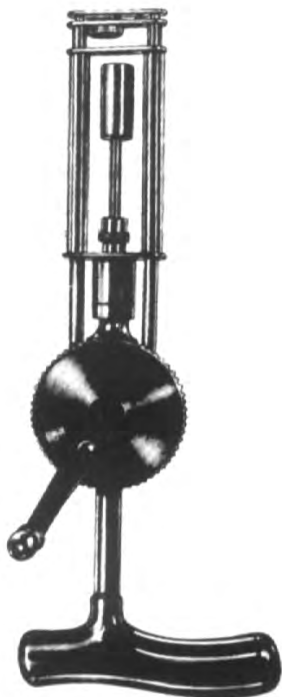

KIRSCHNER
 34250-00 compl.



34252-00

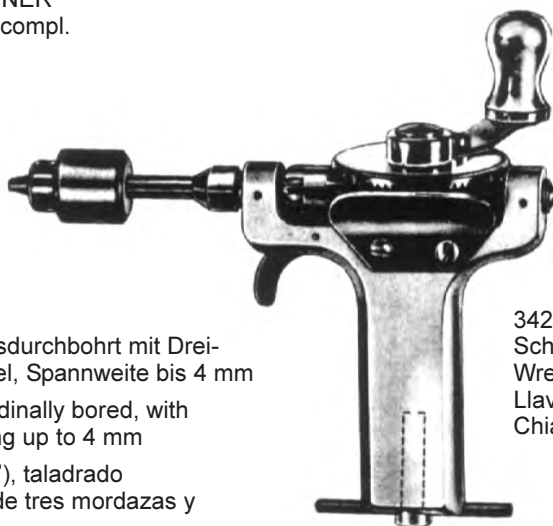

34270-01
 Schlüssel
 Wrench
 Llave
 Chiave

Bohrapparat 16 cm (6 1/4"), längsdurchbohrt mit Drei-
 backenspannfutter und Schlüssel, Spannweite bis 4 mm

Hand drill, 16 cm (6 1/4"), longitudinally bored, with
 three-jaw-chuck and key, opening up to 4 mm

Perforador manual, 16 cm (6 1/4"), taladrado
 longitudinalmente, con mandril de tres mordazas y
 llave, apertura hasta 4 mm

Perforatore a mano, 16 cm (6 1/4"), con perforazione
 assiale, con mandrino a tre ganasce e chiave, apertura
 fino a 4 mm di D.

BUNELL
 34270-00
 16 cm, 6 1/4"

Bohrapparate
Bone Hand Drills
Perforadores de mano
Perforatori a mano



RALK
34280-00

Bohrapparat mit Leichtmetallgehäuse,
mit Dreibackenspannfutter und
Schlüssel, Spannweite bis D. 6,35 mm

Hand drill with light metal case, with
three-jaw-chuck and key, opening up to
D. 6,35 mm

Perforador manual con caja de metal
ligero, con mandril de tres mordazas y
llave, apertura hasta Ø 6,35 mm

Perforatore a mano con cassa in metallo
leggero, con mandrino a tre ganasce e
chiave, apertura fino a 6,35 mm di D.



REDA
34290-00

Handbohrapparat mit umstellbarem
Handgriff, mit Jacobs Dreibackenspann-
futter und Schlüssel

Hand drill with adjustable handle, with
Jacobs three-jaw-chuck and wrench

Perforador manual con mango ajustable,
con mandril Jacobs de 3 mordazas y
llave

Perforatore a mano con manico regola-
bile, con mandrino Jacobs a tre ganasce
complete con chiave



34295-00
Spannschlüssel allein
Key only
Llave sola
Chiave solo

Reda Instrumente GmbH
Gänsäcker 34 - P.O. Box 131
D-78532 Tuttlingen

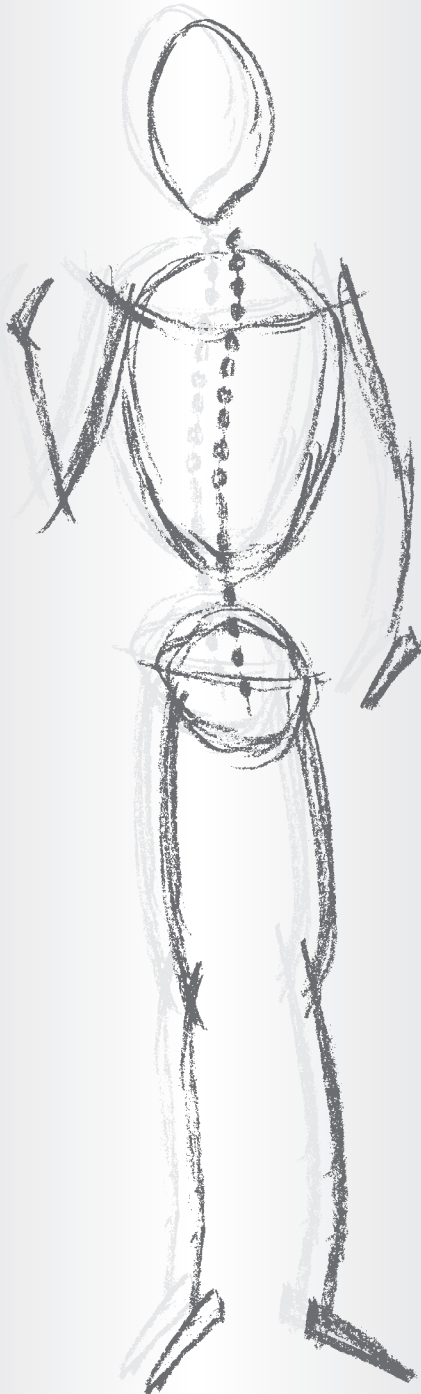

BIPOLARE KOAGULATION

BIPOLAR COAGULATION

COAGULACIÓN BIPOLAR

COAGULAZIONE BIPOLARE



www.Reda-Instrumente.de

Bipolare Koagulation
Bipolar Coagulation
Coagulación bipolar
Coagulazione bipolare



91104-11
11 cm, 4 $\frac{3}{8}$ "
0,5 mm



91109-11
11 cm, 4 $\frac{3}{8}$ "
45°, 0,5 mm



91113-11
11 cm, 4 $\frac{3}{8}$ "
45°, 0,5 mm



91122-16
16,5 cm, 6 $\frac{1}{2}$ "
0,5 mm



91123-16
16,5 cm, 6 $\frac{1}{2}$ "
0,5 mm



91125-16
16,5 cm, 6 $\frac{1}{2}$ "
0,5 mm

Bipolare Koagulation
Bipolar Coagulation
Coagulación bipolar
Coagulazione bipolare



91142-16
16 cm, 6 1/4"
1 mm



91144-16
16,5 cm, 6 1/2"
0,5 mm



91152-19
19,5 cm, 7 3/4"
0,3 mm



91154-19
19,5 cm, 7 3/4"
1 mm



91157-19
19,5 cm, 7 3/4"
1 mm



91159-19
19,5 cm, 7 3/4"
2 mm

Bipolare Koagulation
Bipolar Coagulation
Coagulación bipolar
Coagulazione bipolare



91162-19
19,5 cm, 7 ³/₄"
0,3 mm



91164-19
19,5 cm, 7 ³/₄"
1 mm

Bipolare Koagulation
Bipolar Coagulation
Coagulación bipolar
Coagulazione bipolare



91166-19
19,5 cm, 7 3/4"
2 mm



91172-03
0,3 mm



91172-07
0,7 mm



91172-12
1,2 mm

91172-03 - 91172-12
22,5 cm, 8.9"

Bipolare Koagulation
 Bipolar Coagulation
 Coagulación bipolar
 Coagulazione bipolare

NON STICK

gerade
 straight
 recta
 retta



	0,3 mm	0,5 mm	1,0 mm	2,0 mm
11,0 cm, 4 3/8"	91110-03N	91110-05N	91110-10N	
16,0 cm, 6 1/4"	91160-03N	91160-05N	91160-10N	91160-20N
18,0 cm, 7"		91180-05N	91180-10N	91180-20N
19,5 cm, 7 3/4"		91200-05N	91200-10N	91200-20N
22,0 cm, 8 3/4"			91220-10N	91220-20N
24,0 cm, 9 1/2"			91240-10N	
30,0 cm, 12"			91300-10N	91300-20N

abgewinkelt 45°
 angled 45°
 angulada 45°
 angolata 45°



	0,3 mm	0,5 mm	1,0 mm	2,0 mm
11,0 cm, 4 3/8"	91112-03N	91112-05N	91112-10N	
16,0 cm, 6 1/4"		91162-05N	91162-10N	
18,0 cm, 7"			91182-10N	91182-20N
19,5 cm, 7 3/4"		91202-05N	91202-10N	91202-20N
22,0 cm, 8 3/4"			91222-10N	91222-20N
24,0 cm, 9 1/2"			91242-10N	
30,0 cm, 12"			91302-10N	

NON STICK

Bipolare Koagulation
Bipolar Coagulation
Coagulación bipolar
Coagulazione bipolare

bayonett gerade
bajonett straight
bayoneta recta
baionetta retta



	0,3 mm	0,5 mm	1,0 mm	2,0 mm
16,0 cm, 6 1/4"	91166-03N	91166-05N	91166-10N	91166-20N
19,5 cm, 7 3/4"		91206-05N	91206-10N	91206-20N
22,0 cm, 8 3/4"		91226-05N	91226-10N	91226-20N
24,0 cm, 9 1/2"		91246-05N	91246-10N	91246-20N

bayonett nach oben
bajonett upwards
bayoneta hacia arriba
baionetta in alto



	1,0 mm
19,5 cm, 7 3/4"	91207-10N
22,0 cm, 8 3/4"	91227-10N

bayonett nach unten
bajonett downwards
bayoneta hacia abajo
baionetta in basso



	0,5 mm	1,0 mm
16,0 cm, 6 1/4"	91168-05N	91168-10N
19,5 cm, 7 3/4"		91208-10N
22,0 cm, 8 3/4"		91228-10N

Bipolare Saugpinzetten
Bipolar suction Forceps
Pinza de succión bipolar
Pinza bipolare con canale di aspirazione

Saugpinzetten zum Absaugen von Blut und Sekret vor der Koagulation bzw. zum Absaugen von Rauch während der Koagulation.

Europäischer Flachstecker zum Anschluß von bipolaren Kabeln für praktisch alle gebräuchlichen HF-Generatoren.

Der Saugkanal mit Unterbrecherloch ist in einem Schenkel der Pinzette integriert.

An der Schlaucholive können verschiedene Schlauchdurchmesser angeschlossen werden.

Suction forceps for extraction of blood and debris by suction right before coagulation or extraction of smoke while coagulating.

European flat socket connector for bipolar cables for nearly all common high frequency generators.

Suction channel embedded inside the forceps.

Suction connector matches different suction tube diameters.



Pinza de succión para sangre y líquidos antes de efectuar la coagulación como también para la eliminación de humo durante la coagulación. Enchufe plano europeo para conectar cables bipolares de equipos de alta frecuencia en uso corrientemente.

El canal de succión con su agujero de interrupción está incorporado en un lado de la pinza.

El diseño de la oliva de conexión permite la adaptación de tubos de varios diámetros.

Pinza bipolare dotata di canale di aspirazione. Per aspirare fumi, sangue ecc. durante la coagulazione. Attacco piatto per cavi bipolari con attacchi europei.

Il canale di aspirazione con interruzione é integrato sulla aletta della pinza.

Ingresso del canale di aspirazione ad oliva che permette attacchi di diversi diametri.

Verbindungskabel, bipolar
Connection Cords, bipolar
Cables de conexión, bipolar
Cavi da connessione, bipolare



ERBE
SELECT
STORZ
3 m 118" 91190-30
5 m 197" 91190-50



USA Mod.
91192-30
91192-50



MARTIN
BERCHTOLD
AESCULAP
91193-30
91193-50

für Elektro-Chirurgie-Einheiten
for Electrosurgery Equipment
para Electrobisturías
per Elettrobisturi

Reda Instrumente GmbH
Gänsäcker 34 - P.O. Box 131
D-78532 Tuttlingen

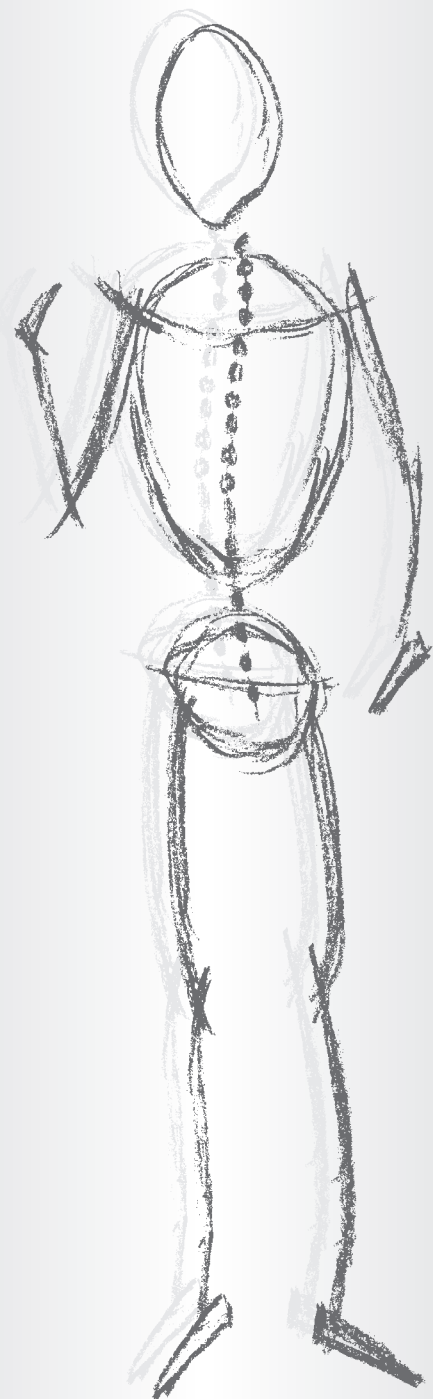

SÄTZE

SET

SET

SET



www.Reda-Instrumente.de

Set / 200 Basic Set for Neurosurgery - Neurochirurgie Set

1x	07103-00	scalpel handle no. 3
1x	07107-00	scalpel handle no. 7
1x	07104-00	scalpel handle no. 4
1x	09160-17	MAYO, dissecting scissors, str., 17cm
1x	09161-17	MAYO, dissecting scissors, cvd., 17cm
1x	09280-18	METZENBAUM, dissecting scissors, str., 18cm
1x	11112-18	POTTS-SMITH, dressing forceps, 18cm
1x	11126-18	POTTS-SMITH, tissue forceps, 1x2 teeth, 18cm
1x	11189-15	BROWN, tissue forceps, 9x9 teeth, 15cm
1x	11315-01	TAYLOR, dressing forceps, bayonet, 17cm
1x	11315-02	TAYLOR, tissue forceps, 1x2 teeth, bayonet, 17cm
1x	41295-10	FRAZIER/FERGUSON, suction tube, 30°, 19cm
2x	25214-18	DeBAKEY, needle holder TC, 18cm
2x	25225-18	RYDER, needle holder TC, 18cm
10x	13220-12	HALSTED-MOSQUITO, hemostatic forceps, str., 12,5cm
6x	13345-14	DANDY, hemostatic forceps, cvd., 14cm
6x	13320-14	ROCHESTER-OCHSNER, hemostatic forceps, 1x2 teeth, str., 14cm
10x	15111-09	BACKHAUS, towel forceps, 9cm
2x	17170-18	FOERSTER, swab forceps, str., 18cm
1x	19214-13	FRAZIER, nerve hooklet, 13cm
1x	19168-06	RIBBON, retractor, 6x200mm
1x	19168-12	RIBBON, retractor, 12x200mm
1x	19168-17	RIBBON, retractor, 17x200mm
1x	19168-25	RIBBON, retractor, 25x200mm
2x	19670-16	WEITLANER, retractor, 16,5cm
2x	19684-16	ADSON-BABY, retractor, 16cm
1x	33711-20	LANGENBECK, periosteal elevator, 20cm
1x	33142-20	ADSON, bone rongeur, str., 20cm
1x	33247-23	LEKSELL-STILLE, bone rongeur, 23cm / 4mm
1x	33245-23	LEKSELL-STILLE, bone rongeur, 23cm / 7mm
6x	65120-15	ALLIS, tissue forceps, 5x6 teeth, 15cm
1x	41512-02	FERRIS-SMITH-KERRISON, rongeur, 45° up, 2mm, 18cm
1x	41512-03	FERRIS-SMITH-KERRISON, rongeur, 45° up, 3mm, 18cm
1x	41512-04	FERRIS-SMITH-KERRISON, rongeur, 45° up, 4mm, 18cm
1x	41432-01	LOVE-GRUENWALD, laminectomy rongeur, str., 3x10mm, 18cm
1x	41432-02	LOVE-GRUENWALD, laminectomy rongeur, 45° up, 3x10mm, 18cm
1x	41432-03	LOVE-GRUENWALD, laminectomy rongeur, 45° down, 3x10mm, 18cm
1x	41254-13	DAVIS, brain spatula, 13mm, 18cm
1x	41161-01	PENFIELD, dura dissector, 17,5cm
1x	41161-02	PENFIELD, dura dissector, 19,5cm
1x	41161-03	PENFIELD, dura dissector, 19,5cm
1x	41161-04	PENFIELD, dura dissector, 21,5cm
1x	41298-12	FRAZIER, canula, 3mm, 12cm
1x	41052-20	DANDY, nerve hook, str., 20cm
1x	19235-21	CUSHING, retractor, 21,5cm
1x	34231-15	ADSON, forceps, 15cm
2x	41094-00	GIGLI, handle for wire saw
5x	41092-50	OLIVECRONA, wire saw, 50cm
1x	41090-33	DE MARTEL, saw conductor, 33cm

Set / 201 Craniotomy Set - Kraniotomie Set

1x	07103-00	scalpel handle no. 3
1x	07107-00	scalpel handle no. 7
1x	07104-00	scalpel handle no. 4
1x	09140-14	DEAVER, dissecting scissors, str., 14,5cm
1x	09160-17	MAYO, dissecting scissors, str., 17cm
1x	09161-17	MAYO, dissecting scissors, cvd., 17cm
1x	09281-18	METZENBAUM, dissecting scissors, cvd., 18cm
2x	11170-12	ADSON, dressing forceps, 12cm
2x	11180-12	ADSON, tissue forceps, 1x2 teeth, 12cm
1x	11220-17	CUSHING, dressing forceps, str., 17cm
1x	11222-17	CUSHING, tissue forceps, str., 1x2 teeth, 17cm
1x	11315-01	TAYLOR, dressing forceps, bayonet, 17cm
1x	11315-02	TAYLOR, tissue forceps, 1x2 teeth, bayonet, 17cm
2x	41295-08	FRAZIER/FERGUSSON, suction tube, 30°, Charr. 8, 19cm
10x	13220-12	HALSTED-MOSQUITO, hemostatic forceps, str., 12,5cm
10x	13221-12	HALSTED-MOSQUITO, hemostatic forceps, cvd., 12cm
10x	13345-14	DANDY, hemostatic forceps, cvd., 14cm
10x	15111-13	BACKHAUS, towel forceps, 13cm
5x	17170-25	FOERSTER, swab forceps, str., 25cm
2x	19235-21	CUSHING, retractor, 21,5cm
2x	19214-13	FRAZIER, nerve hooklet, 13cm
1x	19630-10	JANSEN, retractor, 10cm
2x	19670-20	WEITLANER, retractor, 20cm
1x	33483-00	BRUNS, bone curette, Fig.0, str., 23cm
1x	33483-01	BRUNS, bone curette, Fig.1, str., 23cm
1x	33483-02	BRUNS, bone curette, Fig.2, str., 23cm
1x	33483-03	BRUNS, bone curette, Fig.3, str., 23cm
1x	33137-17	LUER, bone rongeur, cvd., 17cm
1x	33151-16	LEMPERT, bone rongeur, cvd., 16cm
1x	33230-22	STILLE-LUER, bone rongeur, str., 22cm
1x	33231-22	STILLE-LUER, bone rongeur, cvd., 22cm
1x	41096-21	DeVILBIS, skull punch, 21cm
1x	41432-01	LOVE-GRUENWALD, laminectomy rongeur, str., 3x10mm, 18cm
1x	41432-02	LOVE-GRUENWALD, laminectomy rongeur, 45° up, 3x10mm, 18cm
1x	41432-03	LOVE-GRUENWALD, laminectomy rongeur, 45° down, 3x10mm, 18cm
1x	09619-17	SCHMIEDEN-TAYLOR, dura scissors, 17cm
1x	41254-13	DAVIS, brain spatula, 13mm, 18cm
1x	41250-11	CUSHING, brain spatula, 8x10mm
1x	41253-11	OLIVECRONA, brain spatula, 11mm/13mm
1x	41158-01	FRAZIER, dura dissector, 15cm
2x	41298-12	FRAZIER, canula 3mm/12cm
1x	41052-20	DANDY, nerve hook, str., 20cm
1x	19234-20	CUSHING, retractor, 20cm
1x	34240-27	HUDSON, bone hand drill, 27cm
1x	34231-15	ADSON, forceps, 15cm
2x	41094-00	GIGLI, handle for wire saw
10x	41092-50	OLIVECRONA, wire saw, 50cm
2x	41090-33	DeMARTEL, saw conductor, 33cm
1x	41028-00	RANEY, applying forceps
1x	91162-19	bipolar forceps, 0,3mm, 19,5cm
1x	91193-30	bipolar connecting cable, 3 meter

Set / 202 Laminectomy Set - Laminektomie Set

1x	07103-00	scalpel handle no. 3
1x	07104-00	scalpel handle no. 4
1x	09140-14	DEAVER, dissecting scissors, str., 14,5cm
1x	09160-17	MAYO, dissecting scissors, str., 17cm
1x	09161-17	MAYO, dissecting scissors, cvd., 17cm
1x	09281-18	METZENBAUM, dissecting scissors, cvd., 18cm
2x	11102-14	dressing forceps, 14,5cm
1x	11102-20	dressing forceps, 20cm
2x	11120-14	tissue forceps, 1x2 teeth, 14,5cm
1x	11120-20	tissue forceps, 1x2 teeth, 20cm
1x	11220-17	CUSHING, dressing forceps, str., 17cm
1x	11222-17	CUSHING, tissue forceps, str., 1x2 teeth, 17cm
1x	11315-01	TAYLOR, dressing forceps, bayonet, 17cm
1x	11315-02	TAYLOR, tissue forceps, 1x2 teeth, bayonet, 17cm
1x	41295-08	FRAZIER/FERGUSON, suction tube, 30°, Charr.8, 19cm
1x	41295-10	FRAZIER/FERGUSON, suction tube, 30°, Charr. 10, 19cm
1x	41295-12	FRAZIER/FERGUSON, suction tube, 30°, Charr. 12, 19cm
2x	25180-16	MAYO-HEGAR, needle holder, 16cm
10x	13220-12	HALSTED-MOSQUITO, hemostatic forceps, str., 12,5cm
10x	13221-12	HALSTED-MOSQUITO, hemostatic forceps, cvd., 12cm
6x	13263-16	CRILE-RANKIN, hemostatic forceps, cvd., 16cm
6x	13265-16	CRILE-RANKIN, hemostatic forceps, 1x2 teeth, cvd., 16cm
5x	17170-25	FOERSTER, swab forceps, str., 25cm
2x	19235-21	CUSHING, retractor, 21,5cm
2x	19281-04	VOLKMANN, retractor, 4 teeth, 21,5cm
2x	19670-20	WEITLANER, retractor, sharp, 20cm
1x	19686-32	ADSON, retractor, blunt, 32cm
1x	19690-31	BECKMANN, retractor, sharp, 31cm
1x	33711-20	LANGENBECK, elevator, 8mm, 20cm
1x	33710-19	LANGENBECK, elevator, 16mm, 19cm
1x	33700-03	BERGMANN, hammer, Ø 45mm, 300 gr., 24cm
1x	33482-98	BRUNS, bone curette, Fig.00, str., 23cm
1x	33483-00	BRUNS, bone curette, Fig.0, str., 23cm
1x	33483-01	BRUNS, bone curette, Fig.1, str., 23cm
1x	33483-02	BRUNS, bone curette, Fig.2, str., 23cm
1x	33483-03	BRUNS, bone curette, Fig.3, str., 23cm
1x	33483-04	BRUNS, bone curette, Fig.4, str., 23cm
1x	33483-05	BRUNS, bone curette, Fig.5, str., 23cm
1x	33483-06	BRUNS, bone curette, Fig.6, str., 23cm
1x	33136-17	LUER, bone rongeur, str., 17cm
1x	33231-22	STILLE-LUER, bone rongeur, cvd., 22cm
1x	33235-23	STILLE-LUER, bone rongeur, 23cm
1x	33293-27	STILLE-HORSLEY, bone cutting forceps, 27cm
1x	33290-27	STILLE-LISTON, bone cutting forceps, 27cm
5x	65120-15	ALLIS, tissue forceps, 5x6 teeth, 15cm
1x	41512-02	FERRIS-SMITH-KERRISON, 45° up, 2mm, 18cm
1x	41512-03	FERRIS-SMITH-KERRISON, 45° up, 3mm, 18cm
1x	41512-04	FERRIS-SMITH-KERRISON, 45° up, 4mm, 18cm
1x	41432-01	LOVE-GRUENWALD, laminectomy rongeur, str., 3x10mm, 18cm
1x	41432-02	LOVE-GRUENWALD, laminectomy rongeur, 45° up, 3x10mm, 18cm
1x	41432-03	LOVE-GRUENWALD, laminectomy rongeur, 45° down, 3x10mm, 18cm

1x	41151-24	DAVIS, dura dissector, 24cm
1x	47415-18	FREER, septum elevator, 18cm
1x	41161-00	PENFIELD, dura dissector, 17,5cm
1x	41161-02	PENFIELD, dura dissector, 19,5cm
1x	41161-03	PENFIELD, dura dissector, 19,5cm
1x	41161-04	PENFIELD, dura dissector, 21,5cm
1x	41052-20	DANDY, nerve hook, str., 20cm
1x	41056-18	CUSHING, nerve hook, 18cm
1x	41074-23	SCOVILLE, retractor, str., 23cm
1x	19911-00	SCOVILLE, frame only, 15cm
1x	19912-50	SCOVILLE, hook only, 50mm
1x	19917-64	SCOVILLE, blade only, 64x25mm
1x	41020-00	clip carrier with 1 holder
1x	41019-14	OLIVECRONA-TOENNIS, 140mm
1x	91162-19	bipolar forceps, 0,3mm, 19,5cm
1x	91193-30	bipolar connecting cable, 3 meter

Set / 203 Skull Traction Set - Schädel Traktion Set

1x	07103-00	scalpel handle no. 3
1x	09160-14	MAYO, dissecting scissors, str., 14,5cm
1x	11120-14	tissue forceps, 1x2 teeth, 14,5cm
1x	13220-12	HALSTED-MOSQUITO, hemostatic forceps, str., 12,5cm
1x	13221-12	HALSTED-MOSQUITO, hemostatic forceps, cvd., 12cm
2x	17170-25	FOERSTER, swab forceps, str., 25cm
1x	41025-02	CRUTCHFIELD, traction long
1x	34240-27	HUDSON, bone hand drill, complete, 27cm
6x	15111-09	BACKHAUS, towel forceps, 9cm

Set / 204 Transphenoidal Hypophysectomy Set - Transphenoidal Hypophysektomie Set

2x	07103-00	scalpel handle no. 3
1x	07104-00	scalpel handle no. 4
1x	09120-14	operating scissors, standard, str., 14cm
1x	11110-14	dressing forceps, narrow, 14cm
1x	09375-11	STRABISMUS, scissors TC, cvd., 11cm
1x	11170-12	ADSON, dressing forceps, 12cm
1x	11180-12	ADSON, tissue forceps, 1x2 teeth, 12cm
1x	47154-20	JANSEN, nasal forceps, 20cm
2x	41295-08	FRAZIER/FERGUSON, suction tube, 30°, Charr. 8, 19cm
2x	41295-10	FRAZIER/FERGUSON, suction tube, 30°, Charr. 10, 19cm
2x	41295-12	FRAZIER/FERGUSON, suction tube, 30°, Charr. 12, 19cm
2x	25144-13	HALSEY, needle holder TC, 13cm
2x	13221-12	HALSTED-MOSQUITO, hemostatic forceps, cvd., 12cm
2x	13211-10	HARTMANN, hemostatic forceps, cvd., 10cm
2x	13475-14	MIXTER-BABY, hemostatic forceps, 14cm
2x	19160-17	SENN-MILLER, retractor, 3 teeth, 17cm
6x	15111-13	BACKHAUS, towel forceps, 13cm
2x	17170-25	FOERSTER, swab forceps, str., 25cm
2x	19221-03	nerve and wound hooks, 3 prongs, 16cm
1x	41522-03	COLCLOUGH, disc rongeur, 90° up, 3mm, 20cm
1x	41512-02	FERRIS-SMITH-KERRISON, rongeur, 45° up, 2mm, 18cm
1x	41512-03	FERRIS-SMITH-KERRISON, rongeur, 45° up, 3mm, 18cm
1x	41422-01	CUSHING, laminectomy rongeur, str., 2x10mm, 18cm
1x	41432-01	LOVE-GRUENWALD, laminectomy rongeur, str., 3x10mm, 18cm
1x	41432-02	LOVE-GRUENWALD, laminectomy rongeur, 45° up, 3x10mm, 18cm
1x	41442-01	SPURLING, laminectomy rongeur, str., 4x10mm, 18cm
1x	41254-13	DAVIS, brain spatula, 13mm, 18cm
1x	41447-27	LANDOLT, tumor grasping forceps, Ø 9mm, 27cm
1x	93670-01	HARDY, enucleator, blunt, right, 24,5cm
1x	93670-09	HARDY, implant fork, 24,5cm
1x	93700-06	HARDY, curette, malleable, 6mm, 26cm
1x	93660-01	NICOLA, curette, malleable, 6,5mm, right, 21,5cm
1x	93660-02	NICOLA, curette, malleable, 6,5mm, left, 21,5cm
1x	93660-03	NICOLA, curette, malleable, 6,5mm, 21,5cm
1x	93600-01	CUSHING-LANDOLT, specula, 70x15mm
1x	93600-02	CUSHING-LANDOLT, specula, 90x15mm
1x	93605-21	LANDOLT, spreader for specula, 21cm
1x	93710-03	LANDOLT-REULEN, raspatory, 2,2mm, 26cm
1x	93710-04	LANDOLT-REULEN, raspatory, 3,2mm, 26cm
1x	93710-07	LANDOLT-REULEN, dissector, 2,0mm, 26cm
1x	93720-02	NICOLA, forceps, scoop-shaped, str., 16,5cm
1x	93720-04	NICOLA, grasping forceps, str., 16,5cm
1x	93720-03	NICOLA, micro scissors, str., 16,5cm
1x	93630-04	COTTLE, chisel, 4mm, 18,5cm
1x	33700-05	COTTLE, hammer, Ø 30mm, 240 gr., 18cm

Reda Instrumente GmbH
Gänsäcker 34 - P.O. Box 131
D-78532 Tuttlingen



NUMMERNVERZEICHNIS

NUMERICAL INDEX

INDICE NUMÉRICO

INDICE NUMERICO



www.Reda-Instrumente.de

03288-17.....8	09161-17.....22	09287-18.....23	09540-16.....21	10229-18T.....40
03288-20.....8	09161-23.....22	09287-20.....23	09541-16.....21	10229-21.....40
03292-22.....8	09164-14.....22	09287-23.....23	09542-16.....21	10229-23.....40
03294-24.....8	09164-17.....22	09287-25.....23	09543-16.....21	10230-11.....40
03304-20.....8	09164-23.....22	09310-12.....26	09582-15.....27	10230-14.....40
03306-17.....8	09165-14.....22	09310-15.....26	09583-15.....27	10230-18.....40
03308-18.....8	09165-17.....22	09312-12.....26	09601-22.....33	10230-18T.....40
03320-19.....11	09165-23.....22	09314-12.....26	09610-18.....27	10230-21.....40
03340-10.....11	09170-15.....22	09321-15.....26	09611-18.....27	10230-23.....40
03340-15.....11	09170-17.....22	09321-18.....26	09617-17.....33	11112-18.....50
03340-20.....11	09170-21.....22	09322-13.....26	09619-17.....34	11112-21.....50
03340-30.....11	09171-15.....22	09325-15.....26	09620-23.....33	11112-25.....50
03340-50.....11	09171-17.....22	09340-09.....27	09831-12.....34	11116-18.....50
03350-15.....11	09171-21.....22	09340-10.....27	09835-12.....34	11116-21.....50
03360-01.....11	09174-15.....22	09340-11.....27	10120-18.....35	11116-25.....50
07103-00.....14	09174-17.....22	09341-09.....27	10121-18.....35	11126-18.....50
07103-01.....14	09174-21.....22	09341-10.....27	10122-18.....35	11126-21.....50
07106-01.....14	09175-15.....22	09341-11.....27	10123-18.....35	11126-25.....50
07107-00.....15	09175-17.....22	09344-11.....27	10133-10.....36	11070-12.....51
07107-01.....15	09175-21.....22	09345-11.....27	10135-10.....36	11170-15.....51
07109-10.....15	09190-16.....22	09346-11.....27	10140-08.....37	11174-12.....51
07109-13.....15	09191-16.....22	09350-09.....28	10141-08.....37	11174-15.....51
07109-15.....15	09194-16.....22	09351-09.....28	10143-08.....37	11176-12.....51
07161-00.....15	09195-16.....22	09352-09.....28	10202-11.....38	11176-15.....51
07162-00.....15	09280-12.....23	09353-09.....28	10202-14.....38	11177-12.....51
07165-00.....15	09280-15.....23	09360-11.....28	10202-14T.....38	11178-12.....51
07167-00.....15	09280-18.....23	09361-11.....28	10202-18.....38	11179-12.....51
07290-09.....17	09280-20.....23	09362-11.....28	10202-18T.....38	11180-12.....52
07291-11.....17	09280-23.....23	09363-11.....28	10202-21.....38	11180-15.....52
07294-13.....17	09280-25.....23	09371-11B.....25	10202-21T.....38	11181-12.....52
09102-13.....20	09281-12.....23	09473-21.....29	10202-23.....38	11181-15.....52
09102-14.....20	09281-15.....23	09474-22.....29	10203-11.....38	11186-12.....52
09102-16.....20	09281-15B.....24	09475-00.....29	10203-14.....38	11186-15.....52
09102-18.....20	09281-18.....23	09475-25.....29	10203-14T.....38	11187-12.....52
09103-13.....20	09281-18B.....24	09475-45.....29	10203-18.....38	11187-18.....53
09103-14.....20	09281-20.....23	09475-60.....29	10203-18T.....38	11187-20.....53
09103-16.....20	09281-20B.....24	09475-90.....29	10203-21.....38	11187-25.....53
09103-18.....20	09281-23.....23	09476-00.....29	10203-21T.....38	11187-30.....53
09104-14.....20	09281-25.....23	09476-25.....29	10203-23.....38	11188-12.....52
09105-14.....20	09282-15.....23	09476-45.....29	10220-00.....39	11188-15.....52
09110-13.....20	09282-18.....23	09476-60.....29	10220-00T.....39	11189-12.....52
09110-14.....20	09282-20.....23	09476-90.....29	10220-25.....39	11189-15.....53
09110-16.....20	09282-23.....23	09477-01.....30	10220-25T.....39	11189-20.....53
09110-18.....20	09282-25.....23	09478-25.....30	10220-45.....39	11189-25.....53
09111-13.....20	09283-15.....23	09478-45.....30	10220-45T.....39	11220-17.....53
09111-14.....20	09283-15B.....25	09478-60.....30	10220-60.....39	11221-17.....53
09111-16.....20	09283-18.....23	09479-25.....30	10220-60T.....39	11222-17.....53
09111-18.....20	09283-18B.....24	09479-45.....30	10220-90.....39	11223-17.....53
09114-14.....20	09283-20.....23	09479-60.....30	10220-90T.....39	11224-17.....53
09115-14.....20	09283-20B.....24	09480-18.....30	10226-11.....40	11225-17.....53
09120-13.....20	09283-23.....23	09480-25.....31	10226-14.....40	11231-20.....54
09120-14.....20	09283-25.....23	09480-25 SC.....31	10226-18.....40	11233-20.....54
09120-16.....20	09284-12.....23	09480-40.....31	10226-18T.....40	11234-20.....54
09120-18.....20	09284-15.....23	09480-40 SC.....31	10226-21.....40	11235-20.....54
09121-13.....20	09284-18.....23	09480-60.....31	10226-23.....40	11236-15.....54
09121-14.....20	09284-20.....23	09480-60 SC.....31	10227-11.....40	11236-20.....54
09121-16.....20	09284-23.....23	09481-25.....31	10227-14.....40	11237-20.....55
09121-18.....20	09284-25.....23	09481-40.....31	10227-18.....40	11257-15.....55
09124-14.....20	09285-12.....23	09481-60.....31	10227-18T.....40	11258-15.....55
09125-14.....20	09285-15.....23	09490-16.....31	10227-21.....40	11259-15.....55
09130-14.....21	09285-18.....23	09490-23.....31	10227-23.....40	11260-12.....56
09131-14.....21	09285-20.....23	09490-28.....31	10228-11.....40	11260-15.....56
09140-14.....21	09285-23.....23	09491-16.....31	10228-14.....40	11261-15.....56
09141-14.....21	09285-25.....23	09491-23.....31	10228-18.....40	11270-12.....56
09150-14.....21	09286-15.....23	09491-28.....31	10228-18T.....40	11270-15.....56
09151-14.....21	09286-18.....23	09492-16.....31	10228-21.....40	11271-15.....56
09160-14.....22	09286-20.....23	09492-23.....31	10228-23.....40	11271-18.....56
09160-17.....22	09286-23.....23	09492-28.....31	10229-11.....40	11272-15.....56
09160-23.....22	09286-25.....23	09496-15.....32	10229-14.....40	11273-15.....56
09161-14.....22	09287-15.....23	09497-15.....32	10229-18.....40	11274-06.....56

11274-08.....56	12112-18D.....66	13006-10.....78	13115-00.....83	19216-07.....102
11274-10.....56	12112-18T.....66	13006-14.....78	13210-10.....83	19216-10.....102
11302-17.....56	12112-21D.....66	13006-20.....78	13211-10.....83	19234-20.....103
11302-23.....56	12112-21T.....66	13010-30.....79	13212-10.....83	19235-21.....103
11303-17.....56	12112-23D.....66	13010-35.....79	13213-10.....83	19314-07.....104
11304-17.....56	12112-23T.....66	13010-40.....79	13214-10.....83	19314-10.....104
11305-17.....57	12114-15D.....66	13010-50.....79	13215-10.....83	19314-12.....104
11310-17.....57	12114-15T.....66	13011-30.....79	13220-12.....84	19314-14.....104
11311-17.....57	12114-18D.....66	13011-35.....79	13220-14.....84	19314-15.....104
11312-17.....57	12114-18T.....66	13011-40.....79	13220-18.....84	19314-16.....104
11312-18.....57	12114-21D.....66	13011-50.....79	13221-12.....84	19314-20.....104
11313-17.....57	12114-21T.....66	13012-30.....79	13221-14.....84	19315-06.....104
11314-01.....58	12114-23D.....66	13012-35.....79	13221-18.....84	19315-21.....104
11314-02.....58	12114-23T.....66	13012-40.....79	13222-12.....84	19317-21.....105
11315-01.....58	12115-15.....67	13012-50.....79	13223-12.....84	19318-40.....105
11315-02.....58	12115-15T.....67	13013-30.....79	13224-12.....84	19318-57.....105
11324-23.....58	12115-18.....67	13013-35.....79	13225-12.....84	19318-78.....105
11325-15.....58	12115-18T.....67	13013-40.....79	13226-12.....84	19330-40.....104
11325-23.....58	12115-21.....67	13013-50.....79	13227-12.....84	19330-55.....104
11325-25.....58	12115-21T.....67	13014-30.....79	13230-12.....84	19620-07.....120
11326-23.....58	12115-23.....67	13014-35.....79	13230-14.....84	19620-10.....120
11327-10.....59	12115-23T.....67	13014-40.....79	13231-12.....84	19621-07.....120
11327-13.....59	12116-15.....67	13014-50.....79	13231-14.....84	19621-10.....120
11401-01.....60	12116-18.....67	13015-30.....79	13232-12.....84	19630-10.....120
11403-03.....60	12116-21.....67	13015-35.....79	13233-12.....84	19631-10.....120
11403-04.....60	12116-23.....67	13015-40.....79	13240-14.....85	19634-10.....120
11404-04.....60	12117-18.....68	13015-50.....79	13240-18.....85	19635-10.....120
11405-05.....60	12117-21.....68	13090-40.....80	13241-14.....85	19640-14.....127
11407-07.....60	12117-23.....68	13090-45.....80	13241-18.....85	19641-14.....127
11408-01.....61	12118-18.....68	13090-50.....80	13242-16.....85	19650-10.....121
11408-02.....61	12118-21.....68	13091-40.....80	13243-16.....85	19651-10.....121
11408-03.....61	12118-23.....68	13091-45.....80	13244-14.....85	19654-13.....121
11408-04.....61	12295-22.....70	13091-50.....80	13245-14.....85	19655-13.....121
11409-11.....61	12297-22.....70	13092-07.....81	13250-14.....85	19670-14.....121
11410-11.....61	12300-18.....70	13092-08.....81	13250-18.....85	19670-16.....121
11411-11.....61	12302-16.....69	13092-10.....81	13251-14.....85	19670-20.....121
12090-15D.....62	12302-18.....69	13092-12.....81	13251-18.....85	19670-24.....121
12090-18D.....62	12302-20.....69	13093-07.....81	13254-14.....85	19671-14.....121
12090-21D.....62	12302-24.....69	13093-08.....81	13255-14.....85	19671-16.....121
12090-23D.....62	12303-18.....70	13093-10.....81	13262-16.....85	19671-20.....121
12091-15D.....62	12304-16.....69	13093-12.....81	13263-16.....85	19671-24.....121
12091-18D.....62	12304-20.....69	13094-09.....82	13345-12.....86	19672-11.....122
12091-21D.....62	12304-24.....69	13095-10.....82	13345-14.....86	19673-11.....122
12091-23D.....62	12304-30.....69	13096-06.....81	13364-14.....87	19674-15.....122
12102-12.....62	12305-20.....71	13096-07.....81	13366-19.....87	19675-00.....123
12102-12D.....62	12306-16.....69	13096-09.....81	13414-20.....88	19675-13.....122
12102-21.....62	12306-20.....69	13096-11.....81	13415-14.....88	19676-00.....123
12102-21D.....62	12306-24.....69	13097-06.....81	13415-18.....88	19677-13.....124
12102-23.....62	12306-30.....69	13097-07.....81	13431-13.....89	19677-19.....123
12102-23D.....62	12308-16.....69	13097-09.....81	13431-16.....89	19677-25.....123
12103-12.....62	12308-20.....69	13097-11.....81	13431-18.....89	19677-32.....123
12103-12D.....62	12308-24.....69	13098-06.....80	13431-20.....89	19678-05.....123
12103-15.....62	12308-30.....69	13099-07.....80	13431-23.....89	19678-06.....123
12103-15D.....62	12309-16.....69	13102-04.....83	13431-25.....89	19678-16.....124
12104-15.....62	12309-20.....69	13102-05.....83	13431-28.....89	19679-20.....128
12104-15D.....62	12309-24.....69	13103-04.....83	13475-14.....90	19679-22.....124
12108-18.....62	12309-30.....69	13103-05.....83	13475-18.....90	19680-19.....125
12108-18D.....62	12310-16.....69	13110-50.....83	13610-01.....91	19681-19.....125
12109-18.....62	12310-20.....69	13110-55.....83	13610-02.....91	19681-21.....125
12109-18D.....62	12310-24.....69	13110-65.....83	13610-03.....91	19682-26.....126
12109-21.....62	12310-30.....69	13110-70.....83	19128-18.....103	19683-26.....126
12109-21D.....62	13001-08.....78	13110-75.....83	19128-20.....103	19684-14.....126
12109-23.....62	13001-10.....78	13110-90.....83	19128-23.....103	19684-16.....126
12109-23D.....62	13001-12.....78	13111-50.....83	19214-13.....102	19684-20.....126
12110-15.....65	13002-08.....78	13111-55.....83	19214-18.....102	19684-26.....126
12110-20.....65	13002-10.....78	13111-65.....83	19215-13.....102	19685-14.....126
12110-24.....65	13002-12.....78	13111-70.....83	19215-18.....102	19685-16.....126
12110-30.....65	13005-10.....78	13111-75.....83	19216-01.....102	19685-20.....126
12112-15D.....66	13005-14.....78	13111-90.....83	19216-02.....102	19685-26.....126
12112-15T.....66	13005-20.....78	13113-03.....82	19216-05.....102	19686-32.....129

19687-01	130	19729-55T	145	19743-55	157	19802-14	150	25214-23	95
19687-02	130	19729-60T	145	19743-60	157	19802-16	150	25214-26	95
19688-01	130	19729-65T	145	19743-65	157	19802-18	150	25224-13	95
19688-02	130	19729-70T	145	19744-00	154	19910-00	137	25224-15	95
19689-01	131	19730-30T	145	19744-17	154	19910-01	137	25224-18	95
19689-02	131	19730-35T	145	19745-40	154	19911-00	137	25224-20	95
19690-31	132	19730-40T	145	19745-45	154	19911-01	137	25224-23	95
19692-32	132	19730-45T	145	19745-50	154	19912-50	137	25224-26	95
19693-01	128	19730-50T	145	19745-55	154	19912-70	137	25225-13	95
19693-02	128	19730-55T	145	19745-60	154	19913-50	137	25225-15	95
19693-28	133	19730-60T	145	19745-65	154	19913-70	137	25225-18	95
19694-01	106	19730-65T	145	19745-70	154	19914-41	137	25225-20	95
19694-02	106	19730-70T	145	19748-01	148	19914-67	137	25225-23	95
19694-03	106	19731-35T	145	19748-02	148	19915-48	137	25225-26	95
19694-18	134	19731-40T	145	19748-03	148	19915-64	137	25660-12	96
19695-01	135	19731-45T	145	19748-04	148	19916-64	137	25660-13	96
19695-02	135	19731-50T	145	19748-40	155	19916-80	137	25660-14	96
19695-18	134	19731-55T	145	19748-45	155	19917-64	137	25661-12	96
19696-18	147	19731-60T	145	19748-50	155	19918-64	137	25661-13	96
19698-18	147	19731-65T	145	19748-55	155	19918-88	137	25661-14	96
19710-00	140	19731-70T	145	19748-60	155	19919-00	138	25668-18	97
19710-01	140, 141	19731-75T	145	19748-65	155	19919-01	138	25668-21	97
19710-40	140, 142	19732-25T	146	19748-70	155	19919-02	138	25668-23	97
19710-45	140, 142	19732-30T	146	19748-75	155	19919-03	138	25670-14	97
19710-50	140, 142	19732-35T	146	19748-85	155	19919-04	138	25670-18	97
19710-55	140, 142	19732-40T	146	19749-01	148	19919-05	138	25670-21	97
19710-60	140, 142	19732-45T	146	19749-02	148	19920-01	158	25671-12D	96
19711-00	142	19732-50T	146	19750-01	149	19920-02	158	25671-13D	96
19711-01	142, 143	19732-55T	146	19750-02	149	19930-00	156	25671-14	97
19711-40	141, 143	19732-60T	146	19750-03	149	19930-01	156	25671-14D	96
19711-45	141, 143	19732-65T	146	19750-04	149	19930-02	158	25671-18	97
19711-50	141, 143	19732-70T	146	19750-05	149	19930-03	158	25672-14	97
19711-55	141, 143	19736-25T	146	19750-06	149	19940-01	159	25672-14D	97
19711-60	141, 143	19736-30T	146	19751-01	149	19940-02	159	25672-14T	97
19712-00	141	19736-35T	146	19751-02	149	19950-14	160	25672-18	97
19713-00	143	19736-40T	146	19751-03	149	19960-20	160	25672-18D	97
19721-00	144	19736-45T	146	19751-04	149	19970-12	160	25672-18T	97
19721-15	144	19736-50T	146	19751-05	149	19970-14	160	25672-21	97
19724-40	146	19736-55T	146	19751-06	149	19970-16	160	25672-21D	97
19724-45	146	19736-60T	146	19770-00	136	19970-18	160	25672-21T	97
19724-50	146	19736-65T	146	19770-11	136	25130-13	94	25672-23	97
19724-55	146	19736-70T	146	19772-38	136	25134-13	94	25672-23D	97
19724-60	146	19738-45	144, 146	19772-58	136	25140-13	94	25673-14	97
19725-40	146	19738-50	144, 146	19774-32	136	25144-13	94	25673-14D	97
19725-45	146	19738-55	144, 146	19774-37	136	25148-13	94	25673-14T	97
19725-50	146	19738-60	144, 146	19774-43	136	25150-14	94	25673-18	97
19725-55	146	19738-65	144, 146	19774-47	136	25154-14	94	25673-18D	97
19725-60	146	19739-30T	146	19774-52	136	25160-15	94	25673-18T	97
19726-01	144, 156	19739-35T	146	19774-57	136	25160-18	94	25673-21T	97
19727-25T	145	19739-40T	146	19774-62	136	25160-20	94	25674-14	97
19727-30T	145	19739-45T	146	19774-67	136	25160-23	94	25674-18	97
19727-35T	145	19739-50T	146	19776-32	136	25164-15	94	25674-21	97
19727-40T	145	19739-55T	146	19776-37	136	25164-18	94	25675-14	97
19727-45T	145	19739-60T	146	19776-43	136	25164-20	94	25675-18	97
19727-50T	145	19739-65T	146	19776-47	136	25164-23	94	25675-18	97
19727-55T	145	19739-70T	146	19776-52	136	25180-14	95	25677-14	97
19727-60T	145	19739-75T	146	19776-57	136	25180-16	95	25691-18	97
19728-25T	145	19742-35	156, 157	19776-62	136	25180-18	95	25700-18	96
19728-30T	145	19742-40	156, 157	19776-67	136	25180-20	95	25701-18	96
19728-35T	145	19742-45	156, 157	19778-32	136	25180-24	95	25720-12	96
19728-40T	145	19742-50	156, 157	19778-37	136	25180-26	95	25720-12D	96
19728-45T	145	19742-55	156, 157	19778-43	136	25184-14	95	25720-13	96
19728-50T	145	19742-60	156, 157	19778-47	136	25184-16	95	25720-13D	96
19728-55T	145	19742-65	157	19778-52	136	25184-18	95	25720-14	96
19728-60T	145	19742-75	157	19778-57	136	25184-20	95	25720-14D	96
19729-30T	145	19742-85	157	19778-62	136	25184-24	95	25730-18	96
19729-35T	145	19743-35	157	19778-67	137	25184-26	95	25730-18D	96
19729-40T	145	19743-40	157	19779-00	136	25214-16	95	25730-21	96
19729-45T	145	19743-45	157	19802-09	150	25214-18	95	25730-21D	96
19729-50T	145	19743-50	157	19802-11	150	25214-20	95	25730-23	96

25730-23D.....	96	33275-14.....	172	33481-04.....	188	33631-10.....	196	33651-04.....	198
25731-12.....	96	33275-17.....	172	33481-05.....	188	33631-12.....	196	33651-06.....	198
25731-13.....	96	33275-19.....	172	33481-06.....	188	33631-15.....	196	33651-08.....	198
25731-14.....	96	33280-15.....	172	33482-01.....	187	33631-20.....	196	33651-10.....	198
25731-18.....	96	33281-15.....	172	33482-02.....	187	33631-25.....	196	33651-13.....	198
25731-18D.....	96	33282-19.....	172	33482-03.....	187	33631-30.....	196	33651-16.....	198
25731-21.....	96	33283-17.....	172	33482-97.....	188	33632-06.....	196	33651-18.....	198
25731-21D.....	96	33284-15.....	172	33482-98.....	188	33632-08.....	196	33651-20.....	198
25731-23.....	96	33286-18.....	172	33483-00.....	188	33632-10.....	196	33651-25.....	198
25731-23D.....	96	33289-18.....	172	33483-01.....	188	33632-12.....	196	33651-30.....	198
33100-01.....	162	33290-23.....	173	33483-02.....	188	33632-15.....	196	33651-38.....	198
33100-02.....	162	33290-27.....	173	33483-03.....	188	33632-20.....	196	33651-44.....	198
33101-12.....	162	33291-23.....	173	33483-04.....	188	33632-25.....	196	33651-50.....	198
33101-14.....	162	33291-27.....	173	33483-05.....	188	33632-30.....	196	33652-02.....	199
33102-01.....	162	33292-26.....	173	33483-06.....	188	33633-06.....	196	33652-03.....	199
33102-02.....	162	33293-27.....	173	33484-97.....	188	33633-08.....	196	33652-04.....	199
33131-15.....	163	33295-24.....	173	33484-98.....	188	33633-10.....	196	33652-06.....	199
33133-15.....	163	33469-96.....	184	33485-00.....	188	33633-12.....	196	33652-08.....	199
33136-17.....	163	33469-97.....	184	33485-01.....	188	33633-15.....	196	33652-10.....	199
33137-17.....	163	33469-98.....	184	33485-02.....	188	33633-20.....	196	33652-12.....	199
33142-20.....	163	33470-00.....	184	33485-03.....	188	33633-25.....	196	33652-15.....	199
33143-20.....	163	33470-01.....	184	33485-04.....	188	33633-30.....	196	33654-02.....	199
33147-20.....	164	33470-02.....	184	33485-05.....	188	33634-06.....	196	33654-03.....	199
33148-18.....	164	33470-03.....	184	33485-06.....	188	33634-08.....	196	33654-04.....	199
33150-16.....	164	33470-04.....	184	33487-99.....	189	33634-10.....	196	33654-06.....	199
33151-16.....	164	33470-05.....	184	33488-00.....	189	33634-12.....	196	33654-08.....	199
33152-17.....	164	33470-06.....	184	33488-01.....	189	33634-15.....	196	33654-10.....	199
33153-17.....	164	33473-01.....	185	33488-02.....	189	33634-20.....	196	33654-12.....	199
33154-18.....	165	33473-02.....	185	33489-00.....	189	33634-25.....	196	33654-15.....	199
33155-18.....	165	33473-03.....	185	33489-01.....	189	33634-30.....	196	33656-28.....	200
33156-18.....	165	33473-04.....	185	33489-02.....	189	33644-06.....	197	33657-28.....	200
33157-02.....	165	33473-05.....	185	33489-03.....	189	33644-09.....	197	33658-28.....	200
33157-03.....	165	33473-06.....	185	33490-10.....	190	33644-13.....	197	33659-28.....	200
33157-04.....	166	33474-96.....	184	33490-20.....	190	33644-16.....	197	33660-07.....	201
33157-05.....	166	33474-97.....	184	33490-30.....	190	33644-19.....	197	33660-10.....	201
33157-06.....	166	33474-98.....	184	33490-40.....	190	33644-25.....	197	33660-15.....	201
33158-03.....	166	33475-00.....	184	33490-50.....	190	33644-32.....	197	33660-20.....	201
33158-04.....	166	33475-01.....	184	33491-01.....	190	33645-06.....	197	33660-25.....	201
33158-05.....	166	33475-02.....	184	33491-02.....	190	33645-09.....	197	33660-30.....	201
33159-03.....	166	33475-03.....	184	33491-03.....	190	33645-13.....	197	33661-07.....	201
33159-04.....	166	33475-04.....	184	33491-04.....	190	33645-16.....	197	33661-10.....	201
33159-05.....	166	33475-05.....	184	33491-05.....	191	33645-19.....	197	33661-15.....	201
33159-20.....	166	33475-06.....	184	33491-06.....	191	33645-25.....	197	33661-20.....	201
33201-18.....	167	33476-01.....	186	33491-07.....	191	33645-32.....	197	33661-25.....	201
33202-18.....	167	33476-02.....	186	33491-08.....	191	33647-06.....	197	33661-30.....	201
33205-18.....	167	33476-03.....	186	33492-13.....	192	33647-09.....	197	33664-04.....	201
33211-15.....	167	33476-98.....	186	33492-16.....	192	33647-14.....	197	33664-06.....	201
33213-15.....	167	33476-99.....	186	33492-20.....	192	33647-16.....	197	33664-08.....	201
33216-18.....	168	33477-00.....	186	33494-13.....	192	33647-19.....	197	33664-10.....	201
33217-18.....	168	33477-01.....	186	33494-14.....	192	33647-25.....	197	33664-12.....	201
33219-23.....	168	33477-02.....	186	33494-17.....	192	33647-32.....	197	33665-04.....	201
33220-20.....	168	33477-03.....	186	33495-16.....	192	33649-09.....	197	33665-06.....	201
33230-22.....	169	33477-04.....	186	33500-01.....	191	33649-14.....	197	33665-08.....	201
33230-26.....	169	33477-05.....	186	33500-02.....	191	33649-16.....	197	33665-10.....	201
33231-22.....	169	33477-06.....	186	33500-03.....	191	33649-19.....	197	33665-12.....	201
33231-26.....	169	33478-98.....	187	33508-22.....	194	33649-25.....	197	33665-24.....	202
33235-23.....	169	33478-99.....	187	33509-03.....	195	33649-32.....	197	33665-26.....	202
33237-23.....	169	33479-00.....	187	33509-05.....	195	33650-04.....	198	33665-55.....	202
33241-30.....	170	33479-01.....	187	33509-08.....	195	33650-06.....	198	33665-90.....	202
33243-30.....	170	33479-02.....	187	33510-12.....	195	33650-08.....	198	33666-22.....	202
33245-23.....	170	33479-03.....	187	33510-14.....	195	33650-10.....	198	33667-06.....	203
33247-23.....	170	33479-04.....	187	33510-16.....	195	33650-13.....	198	33667-08.....	203
33257-23.....	171	33479-05.....	187	33630-06.....	196	33650-16.....	198	33667-11.....	203
33258-23.....	171	33479-06.....	187	33630-08.....	196	33650-18.....	198	33667-16.....	203
33259-23.....	171	33480-97.....	188	33630-10.....	196	33650-20.....	198	33669-05.....	203
33260-24.....	171	33480-98.....	188	33630-12.....	196	33650-25.....	198	33669-10.....	203
33261-22.....	171	33481-00.....	188	33630-15.....	196	33650-30.....	198	33669-15.....	203
33274-14.....	172	33481-01.....	188	33630-20.....	196	33650-38.....	198	33670-05.....	203
33274-17.....	172	33481-02.....	188	33630-25.....	196	33650-44.....	198	33670-10.....	203
33274-19.....	172	33481-03.....	188	33630-30.....	196	33650-50.....	198	33670-15.....	203

33691-34	9	33749-19	217	34816-19	181	41158-03	223	41290-21	230
33694-01	9	33750-08	217	41011-15	174	41161-01	224	41294-40	230
33694-03	9	33750-17	217	41011-19	174	41161-02	224	41295-06	231
33695-40	9	33751-01	260	41015-23	174	41161-03	224	41295-07	231
33699-17	9	33751-02	260	41015-26	174	41161-04	224	41295-08	231
33700-01	10	33751-03	260	41017-23	174	41161-05	224	41295-09	231
33700-01-01	10	33753-01	260	41017-26	174	41170-01	256	41295-10	231
33700-05	10	33753-02	260	41019-14	174	41170-02	256	41295-11	231
33700-07	10	33753-03	260	41020-00	174	41170-03	256	41295-12	231
33701-16	206	33754-17	218	41025-01	176	41170-04	256	41295-15	231
33702-15	206	33755-17	218	41025-02	176	41170-05	256	41297-06	231
33703-15	206	33756-17	218	41026-35	176	41170-06	256	41297-07	231
33704-01	206	33757-17	218	41026-50	176	41170-07	256	41297-08	231
33704-02	207	33758-04	217	41027-00	176	41170-08	256	41297-09	231
33705-05	207	33758-06	217	41028-00	176	41170-09	256	41297-10	231
33705-10	207	33758-08	218	41051-20	108	41170-10	256	41297-11	231
33705-15	207	33759-06	218	41052-20	108	41170-11	256	41297-12	231
33705-20	207	33759-12	218	41053-20	108	41170-12	256	41298-12	231
33705-25	207	33759-19	218	41054-20	109	41170-13	256	41299-03	231
33706-18	207	33759-25	218	41056-18	109	41170-14	256	41299-05	231
33707-15	207	33765-17	219	41056-28	109	41170-15	256	41299-07	231
33707-17	208	33767-19	219	41058-18	109	41210-23	261	41300-00	231
33708-19	208	33831-16	107	41058-28	109	41211-23	261	41300-02	232
33709-00	10	33833-16	107	41061-16	110	41213-23	261	41300-03	232
33709-01	10	33966-11	92	41064-16	110	41221-00	262	41300-04	232
33709-02	10	34210-20	322	41068-20	110	41222-00	262	41300-05	232
33709-03	10	34212-25	322	41069-20	110	41223-00	262	41300-06	231
33709-21	208	34212-30	322	41070-29	110	41224-00	262	41300-09	231
33710-01	208	34212-35	322	41074-23	111	41230-01	248	41301-15	232
33710-02	208	34212-40	322	41075-24	111	41230-02	248	41301-20	232
33710-07	209	34214-05	322	41076-03	111	41230-03	248	41301-25	232
33710-15	209	34214-08	322	41076-04	111	41230-05	248	41301-35	232
33710-19	209	34214-10	322	41076-05	111	41230-06	248	41302-01	232
33710-20	209	34214-12	322	41076-07	111	41231-19	249	41302-02	232
33711-16	210	34214-16	322	41077-04	112	41232-19	249	41303-09	233
33711-18	209	34216-10	322	41077-06	112	41233-19	249	41303-12	233
33711-20	209	34216-15	322	41077-08	112	41234-19	249	41303-15	233
33711-21	209	34216-20	322	41077-10	112	41236-19	118, 249	41303-18	233
33712-16	210	34220-24	323	41078-23	113	41237-19	118, 249	41303-25	233
33713-16	210	34222-25	323	41079-21	113	41238-19	249	41303-30	233
33713-17	210	34222-30	323	41080-19	114	41238-19-05	250	41303-45	233
33714-15	210	34222-35	323	41081-19	114	41238-19-10	250	41304-06	233
33715-20	210	34230-28	323	41083-19	114	41238-19-15	250	41304-08	233
33716-18	210	34231-15	181	41085-20	114	41239-19	249	41304-10	233
33717-19-01	211	34232-00	323	41090-33	177	41240-16	250	41306-00	234
33717-19-02	211	34240-27	324	41091-31	114	41242-19	116	41306-05	232, 234
33718-16	211	34241-00	324	41091-41	114	41243-19	116	41306-07	232, 234
33719-17	211	34242-09	324	41092-30	177	41244-19	116	41306-09	232, 234
33720-19	211	34242-14	324	41092-40	177	41245-19	116	41306-12	232
33720-21	211	34242-16	324	41092-50	177	41249-07	274	41308-00	234
33721-17	212	34242-22	324	41092-60	177	41249-10	274	41401-16	151
33722-06	213	34243-02	324	41092-70	177	41249-13	274	41405-17	152
33722-08	213	34244-10	324	41093-00	177	41249-16	274	41405-27	152
33723-17	212	34244-14	324	41094-00	177	41249-19	274	41406-01	153
33725-17	212	34244-16	324	41095-00	177	41249-22	274	41406-02	153
33727-17	212	34244-17	324	41096-21	178	41250-11	274	41420-01	238
33728-24	213	34246-00	324	41097-22	179	41250-15	274	41420-02	238
33729-24	213	34248-00	324	41098-20	180	41250-18	274	41420-03	238
33731-22	214	34250-00	325	41141-25	221	41253-07	274	41421-01	238
33733-22	214	34252-00	325	41142-19	221	41253-11	274	41421-02	238
33740-19	215	34270-00	325	41143-21	221	41253-15	274	41421-03	238
33741-18	215	34270-01	325	41146-18	221	41253-18	274	41422-01	238
33742-18	215	34280-00	326	41146-24	221	41254-06	275	41422-02	238
33743-18	215	34290-00	326	41147-21	222	41254-10	275	41422-03	238
33745-19	216	34295-00	326	41149-22	222	41254-13	275	41430-01	238
33746-19	216	34815-03	182	41151-24	222	41254-16	275	41430-02	238
33747-18	216	34815-04	182	41155-20	222	41254-19	275	41430-03	238
33748-20	216	34815-06	182	41156-18	223	41254-25	275	41431-01	238
33749-10	217	34816-13	181	41158-01	223	41254-32	275	41431-02	238
33749-13	217	34816-16	181	41158-02	223	41254-38	275	41431-03	238

41432-01	238	41480-02	242	41520-03	286	41605-12	295	41615-50	297
41432-02	238	41480-03	242	41520-05	286	41605-12T	295	41615-50T	297
41432-03	238	41481-01	242	41522-03	286	41605-13	295	41615-51	297
41440-01	238	41481-02	242	41522-05	286	41605-13T	295	41615-51T	297
41440-02	238	41481-03	242	41524-03	286	41606-62	295	41616-79	298
41440-03	238	41482-01	242	41524-05	286	41606-62T	295	41616-79T	298
41441-01	238	41482-02	242	41526-03	286	41606-65	295	41616-91	298
41441-02	238	41482-03	242	41526-05	286	41606-65T	295	41616-91T	298
41441-03	238	41490-01	243	41527-03	286	41606-78	295	41617-10	298
41442-01	238	41490-02	243	41527-05	286	41606-78T	295	41617-10T	298
41442-02	238	41490-03	243	41529-03	286	41606-84	295	41617-65	298
41442-03	238	41492-01	243	41529-05	286	41606-84T	295	41617-65T	298
41445-25	245	41492-02	243	41540-02	284	41607-56	295	41617-72	298
41446-02	245	41492-03	243	41540-02B	285	41607-56T	295	41617-72T	298
41446-03	245	41494-01	243	41540-03	284	41607-57	295	41617-78	298
41446-09	245	41494-02	243	41540-03B	285	41607-57T	295	41617-78T	298
41448-02	239	41494-03	243	41540-04	284	41607-58	295	41618-55	298
41448-03	239	41496-01	243	41540-04B	285	41607-58T	295	41618-55T	298
41448-04	239	41496-02	243	41540-05	284	41607-59	295	41618-56	298
41449-01	239	41496-03	243	41540-05B	285	41607-59T	295	41618-56T	298
41449-02	239	41510-01	282	41542-02	284	41607-60	295	41618-57	298
41449-03	239	41510-01B	283	41542-02B	285	41607-60T	295	41618-57T	298
41450-00	240	41510-02	282	41542-03	284	41607-72	295	41618-79	298
41451-01	241	41510-02B	283	41542-03B	285	41607-72T	295	41618-79T	298
41451-02	241	41510-03	282	41542-04	284	41607-73	295	41618-88	298
41451-03	241	41510-03B	283	41542-04B	285	41607-73T	295	41618-88T	298
41452-01	241	41510-04	282	41542-05	284	41607-82	295	41619-00	298
41452-02	241	41510-04B	283	41542-05B	285	41607-82T	295	41619-00T	298
41452-03	241	41510-05	282	41600-62	294	41608-57	295	41620-58	299
41453-01	241	41510-05B	283	41600-62T	294	41608-57T	295	41620-58T	299
41453-02	241	41511-01	282	41600-70	294	41608-80	295	41620-59	299
41453-03	241	41511-02	282	41600-70T	294	41608-80T	295	41620-59T	299
41458-20	241	41511-03	282	41600-78	294	41609-70	295	41620-60	299
41460-01	242	41511-04	282	41600-78T	294	41609-70T	295	41620-60T	299
41460-02	242	41511-05	282	41600-92	294	41610-61	296	41620-61	299
41460-03	242	41512-01	282	41600-92T	294	41610-61T	296	41620-61T	299
41461-01	242	41512-01B	283	41601-10	294	41610-68	296	41620-62	299
41461-02	242	41512-02	282	41601-10T	294	41610-68T	296	41620-62T	299
41461-03	242	41512-02B	283	41601-11	294	41610-70	296	41620-63	299
41462-01	242	41512-03	282	41601-11T	294	41610-70T	296	41620-63T	299
41462-02	242	41512-03B	283	41601-13	294	41611-74	296	41620-70	299
41462-03	242	41512-04	282	41601-13T	294	41611-74T	296	41620-70T	299
41465-01	242	41512-04B	283	41602-60	294	41611-87	296	41620-78	299
41465-02	242	41512-05	282	41602-60T	294	41611-87T	296	41620-78T	299
41465-03	242	41512-05B	283	41602-68	294	41611-92	296	41620-88	299
41466-01	242	41513-01	282	41602-68T	294	41611-92T	296	41620-88T	299
41466-02	242	41513-01B	283	41602-75	294	41612-07	296	41621-58	299
41466-03	242	41513-02	282	41602-75T	294	41612-07T	296	41621-58T	299
41467-01	242	41513-02B	283	41602-87	294	41612-09	296	41621-62	299
41467-02	242	41513-03	282	41602-87T	294	41612-09T	296	41621-62T	299
41467-03	242	41513-03B	283	41603-55	294	41612-11	296	41622-58	299
41470-01	242	41513-04	282	41603-55T	294	41612-11T	296	41622-58T	299
41470-02	242	41513-04B	283	41603-61	294	41612-12	296	41622-62	299
41470-03	242	41513-05	282	41603-61T	294	41612-12T	296	41622-62T	299
41471-01	242	41513-05B	283	41603-65	294	41612-62	296	41623-56	299
41471-02	242	41514-01	282	41603-65T	294	41612-62T	296	41623-56T	299
41471-03	242	41514-02	282	41603-74	294	41613-74	297	41624-56	299
41472-01	242	41514-03	282	41603-74T	294	41613-74T	297	41624-56T	299
41472-02	242	41514-04	282	41604-54	294	41613-84	297	41625-56	299
41472-03	242	41514-05	282	41604-54T	294	41613-84T	297	41625-56T	299
41475-01	242	41515-01	282	41604-58	294	41613-96	297	41626-56	299
41475-02	242	41515-01B	283	41604-58T	294	41613-96T	297	41626-56T	299
41475-03	242	41515-02	282	41604-62	294	41614-58	297	41627-33	300
41476-01	242	41515-02B	283	41604-62T	294	41614-58T	297	41627-33T	300
41476-02	242	41515-03	282	41604-79	294	41614-65	297	41627-40	300
41476-03	242	41515-03B	283	41604-79T	294	41614-65T	297	41627-40T	300
41477-01	242	41515-04	282	41604-87	294	41614-72	297	41628-33	300
41477-02	242	41515-04B	283	41604-87T	294	41614-72T	297	41628-33T	300
41477-03	242	41515-05	282	41605-10	295	41615-49	297	41628-40	300
41480-01	242	41515-05B	283	41605-10T	295	41615-49T	297	41628-40T	300

41628-46	300	41649-11	304	41711-11	315	41801-01	276	57141-36	48
41628-46T	300	41650-07	304	41711-17	315	41802-00	279	57262-00	139
41629-32	300	41650-09	304	41712-08	315	41802-02	276	61460-15	319
41629-32T	300	41650-11	304	41712-11	315	41803-01	278	61460-19	319
41629-38	300	41651-07	304	41712-17	315	41807-00	278	61461-15	319
41629-38T	300	41651-09	304	41713-08	315	41810-10	276, 278, 279	61461-19	319
41630-36	300	41651-11	304	41713-11	315	41821-21	277, 278	61461-28	320
41630-36T	300	41652-07	304	41713-17	315	41822-22	276, 277	61462-19	319
41630-38	300	41652-09	304	41714-08	315	41826-26	276, 277	61462-28	320
41630-38T	300	41652-11	304	41714-11	315	41830-30	276, 277, 279	61463-19	319
41631-36	300	41653-18	305	41714-17	315	41832-32	277	61463-28	320
41631-36T	300	41654-18	305	41715-08	315	41842-42	279, 280	61464-15	319
41631-40	300	41655-18	305	41715-11	315	41842-44	280	61464-19	319
41631-40T	300	41656-18	305	41715-17	315	41842-46	280	61464-28	320
41631-44	300	41657-17	305	41716-08	315	41843-50	279, 280	61465-15	319
41631-44T	300	41657-21	305	41716-11	315	41850-41	279, 280	61465-19	319
41632-36	300	41657-23	305	41716-17	315	41860-14	275	61465-28	320
41632-36T	300	41658-17	305	41717-08	315	41860-17	275	61466-15	319
41633-35	300	41658-21	305	41717-11	315	41860-20	275	61466-19	319
41633-35T	300	41658-23	305	41717-17	315	41870-08	275	61466-28	320
41633-40	300	41659-17	305	41718-25	315	41870-11	275	61467-15	319
41633-40T	300	41659-21	305	41718-36	315	41870-14	275	61467-19	319
41634-35	300	41659-23	305	41719-25	315	41870-17	275	61467-28	320
41634-35T	300	41660-17	305	41719-36	315	41880-01	275, 279	61468-19	319
41634-60	300	41660-21	305	41720-25	315	41880-02	275, 279	61468-28	320
41634-60T	300	41660-23	305	41720-36	315	41880-03	275	61469-19	319
41634-70	300	41661-40	306	41721-25	315	45075-00	11	61469-28	320
41634-70T	300	41661-50	306	41721-36	315	45206-14	74	61470-15	319
41635-57	300	41662-50	306	41722-08	316	45206-16	74	61470-19	319
41635-57T	300	41663-01	306, 308, 309	41722-11	316	45208-14	74	61471-15	319
41636-45	300	41663-02	306, 308, 309	41722-14	316	47154-20	74	61471-19	319
41636-45T	300	41664-10	307	41722-17	316	47155-20	74	61471-28	320
41637-33	301	41664-14	307	41722-23	316	47223-01	244	61472-19	319
41637-33T	301	41665-10	307	41723-08	316	47223-02	244	61472-28	320
41637-40	301	41665-14	307	41723-11	316	47223-03	244	61473-19	319
41637-40T	301	41666-00	307	41723-14	316	47223-04	244	61473-28	320
41638-38	301	41667-30	308	41723-17	316	47223-05	244	61481-15	319
41638-38T	301	41667-50	308	41723-23	316	47224-01	244	61481-19	319
41638-46	301	41668-50	308	41724-08	317	47224-02	244	61482-15	319
41638-46T	301	41669-50	308	41724-11	317	47224-03	244	61482-19	319
41639-44	301	41670-50	308	41724-14	317	47224-04	244	61482-28	320
41639-44T	301	41672-01	309	41724-17	317	47224-05	244	61483-19	319
41640-40	301	41672-02	309	41724-23	317	47303-03	287	61483-28	320
41640-40T	301	41672-03	309	41725-08	317	47303-04	287	61484-19	319
41641-07	302	41672-04	309	41725-11	317	47303-05	287	61484-28	320
41641-09	302	41674-50	310	41725-14	317	47303-06	287	91104-11	328
41641-11	302	41674-80	310	41725-17	317	47304-01	287	91109-11	328
41642-07	302	41675-50	310	41725-23	317	47304-02	287	91110-03N	332
41642-09	302	41675-80	310	41726-08	316	47304-03	287	91110-05N	332
41642-11	302	41676-50	310	41726-11	316	47304-04	287	91110-10N	332
41643-07	302	41676-80	310	41726-14	316	47311-10	288	91112-03N	332
41643-09	302	41677-50	310	41726-17	316	47311-25	288	91112-05N	332
41643-11	302	41677-80	310	41726-23	316	47311-30	288	91112-10N	332
41644-07	302	41678-50	310	41727-08	316	47316-16	288	91113-11	328
41644-09	302	41678-80	310	41727-11	316	47347-20	235	91122-16	328
41644-11	302	41679-00	312	41727-14	316	47411-16	219	91123-16	328
41645-07	303	41679-01	312	41727-17	316	47412-20	219	91125-16	328
41645-09	303	41679-25	311	41727-23	316	47413-19	220	91142-16	329
41645-11	303	41680-00	311	41728-08	317	47415-18	220	91144-16	329
41646-07	303	41690-00	312	41728-11	317	47417-19	220	91152-19	329
41646-09	303	41690-01	312	41728-14	317	47419-19	220	91154-19	329
41646-11	303	41700-01	313	41728-17	317	47454-04	204	91157-19	329
41647-07	303	41700-02	313	41728-23	317	47454-07	204	91159-19	329
41647-09	303	41700-03	314	41729-08	317	47454-09	204	91160-03N	332
41647-11	303	41700-04	314	41729-11	317	47454-12	204	91160-05N	332
41648-07	303	41700-05	314	41729-14	317	47558-15	102	91160-10N	332
41648-09	303	41710-08	315	41729-17	317	47560-18	102	91160-20N	332
41648-11	303	41710-11	315	41729-23	317	47562-18	102	91162-05N	332
41649-07	304	41710-17	315	41730-15	318	57131-26	48	91162-10N	332
41649-09	304	41711-08	315	41731-15	318	57137-27	48	91162-19	330

91164-19	330	93107-22	42	93292-20	75	93462-20	251	93690-01	267
91166-03N	333	93108-22	42	93292-22	75	93462-23	251	93700-03	268
91166-05N	333	93109-22	42	93292-24	75	93463-20	251	93700-05	268
91166-10N	333	93111-20	43	93294-18	75	93463-23	251	93701-03	268
91166-19	331	93113-20	43	93300-22	72	93464-20	251	93701-05	268
91166-20N	333	93115-19	43	93300-24	72	93464-23	251	93702-03	268
91168-05N	333	93170-16	99	93302-22	72	93465-20	251	93702-05	268
91168-10N	333	93170-18	99	93302-24	72	93465-23	251	93703-03	268
91172-03	331	93171-16	99	93304-24	72	93466-20	251	93703-05	268
91172-07	331	93171-18	99	93306-22	72	93466-23	251	93704-24	269
91172-12	331	93180-12	44	93308-22	72	93467-20	251	93705-00	269
91180-05N	332	93180-16	44	93310-22	72	93467-23	251	93710-01	270
91180-10N	332	93180-18	44	93312-22	72	93470-20	252	93710-02	270
91180-20N	332	93181-12	44	93321-23	73	93470-23	252	93710-03	270
91182-10N	332	93181-16	44	93323-23	73	93471-20	252	93710-04	270
91182-20N	332	93181-18	44	93325-23	73	93471-23	252	93710-05	270
91190-30	335	93182-16	44	93327-23	73	93472-20	252	93710-06	270
91190-50	335	93183-16	44	93329-23	73	93472-23	252	93710-07	270
91192-30	335	93190-12	44	93331-23	73	93473-20	252	93720-01	271
91192-50	335	93190-16	44	93340-15	63	93473-23	252	93720-02	271
91193-30	335	93191-12	44	93342-15	63	93474-23	252	93720-03	271
91193-50	335	93191-16	44	93342-18	63	93475-23	252	93720-04	271
91200-05N	332	93192-13	44	93350-12	64	93480-23	227	93730-04	272
91200-10N	332	93193-12	44	93350-13	64	93481-20	227	93730-06	272
91200-20N	332	93195-18	44	93351-13	64	93482-23	227	93731-04	272
91201-20 S	334	93200-16	100	93360-09	64	93483-23	227	93740-01	272
91202-05N	332	93200-18	100	93370-14	64	93484-23	227	93740-02	272
91202-10N	332	93201-16	100	93370-18	64	93485-18	227	93750-01	272
91202-20N	332	93201-18	100	93380-13	16	93486-21	227	93750-02	272
91206-05N	333	93210-12	45	93380-15	16	93487-18	227	93750-03	272
91206-10N	333	93210-16	45	93380-18	16	93490-01	228	93750-04	272
91206-20N	333	93210-18	45	93380-20	16	93490-02	228	93755-14	47
91207-10N	333	93211-12	45	93385-21	16	93490-03	228	93756-14	47
91208-10N	333	93211-16	45	93385-25	16	93490-04	228	93757-14	47
91220-10N	332	93211-18	45	93390-21	16	93490-05	228		
91220-20N	332	93212-16	45	93400-01	115	93490-06	228		
91222-10N	332	93213-16	45	93400-02	115	93500-18	253		
91222-20N	332	93216-12	45	93401-01	115	93501-23	253		
91226-05N	333	93216-16	45	93401-02	115	93505-01	254		
91226-10N	333	93217-12	45	93402-01	115	93505-02	254		
91226-20N	333	93217-16	45	93402-02	115	93505-03	254		
91227-10N	333	93218-13	45	93403-01	115	93505-04	254		
91228-10N	333	93219-12	45	93403-02	115	93506-05	257		
91240-10N	332	93221-18	45	93405-01	116	93506-08	257		
91242-10N	332	93250-15T	96	93405-02	116	93510-18	255		
91246-05N	333	93250-18T	96	93405-03	116	93600-01	263		
91246-10N	333	93250-21T	96	93405-04	116	93600-02	263		
91246-20N	333	93251-15T	96	93410-01	225	93600-03	263		
91300-10N	332	93251-18T	96	93410-02	225	93605-21	263		
91300-20N	332	93251-21T	96	93410-03	225	93610-11	264		
91302-10N	332	93260-15T	96	93410-05	225	93610-13	264		
93092-20	98	93260-18T	96	93410-06	225	93610-15	264		
93092-22	98	93260-21T	96	93410-07	225	93615-01	264		
93093-16	98	93261-15T	96	93420-01	226	93620-14	264		
93093-20	98	93261-18T	96	93420-02	226	93660-01	265		
93093-22	98	93261-21T	96	93420-03	226	93660-02	265		
93093-24	98	93270-14	46	93420-04	226	93660-03	265		
93094-16	41	93270-18	46	93430-01	193	93660-04	265		
93094-20	41	93270-23	46	93430-02	193	93670-01	266		
93095-16	41	93271-14	46	93430-03	193	93670-02	266		
93095-20	41	93271-18	46	93440-01	117	93670-05	266		
93097-20	41	93273-14	46	93440-02	117	93670-06	266		
93098-20	41	93273-18	46	93440-03	117	93670-09	266		
93099-20	41	93290-16	75	93450-01	118	93670-10	266		
93100-22	42	93290-18	75	93450-02	118	93670-12	266		
93101-22	42	93290-20	75	93450-04	118	93680-01	267		
93102-22	42	93290-22	75	93460-20	251	93680-02	267		
93103-22	42	93290-24	75	93460-23	251	93680-05	267		
93103-24	42	93292-16	75	93461-20	251	93680-06	267		
93105-22	42	93292-18	75	93461-23	251	93680-07	267		

Reda Instrumente GmbH
Gänsäcker 34 - P.O. Box 131
D-78532 Tuttlingen

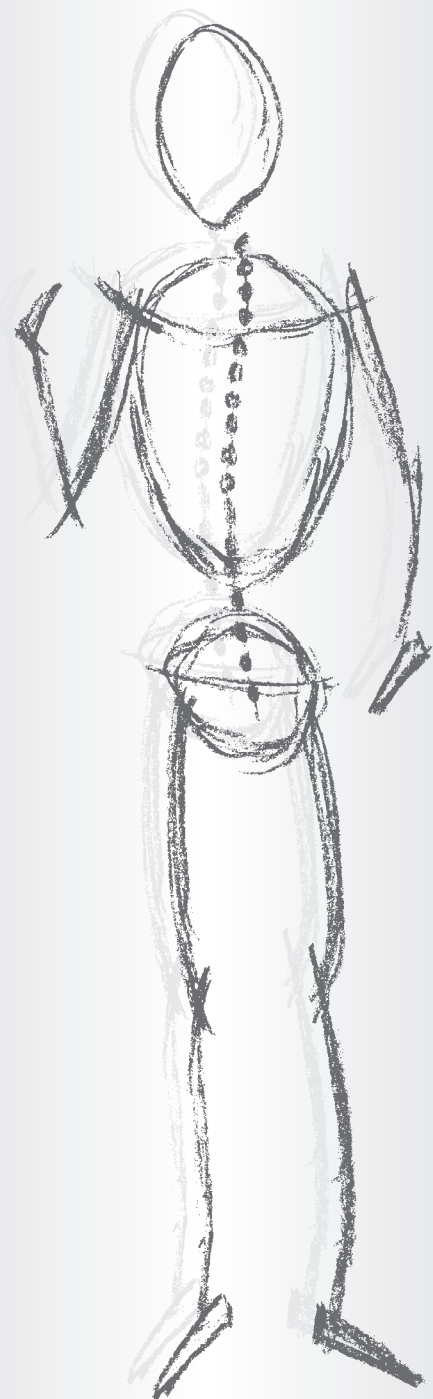

ALPHABETISCHER INDEX

ALPHABETICAL INDEX

INDEX ALPHABÉTICO

INDICE ALFABETICO



www.Reda-Instrumente.de

A		B		C	
AACHEN, Hirnspatel.....	274	BABINSKY, Perkussionshammer.....	8	CAROLL, Sehnenfaßzange.....	92
ACLAND, Clip-Anlegepinzette.....	318	BACON, Hohlmeißelzange.....	166	CASPAR, Blätter.....	136
ACLAND, Mikro-Gefäßclip, Arterie + Vene.....	315 - 317	BADGLEY, Laminektomie-Spreizer.....	139	CASPAR, Cervicalspreizer.....	144, 154
Adapter, HOUSE.....	231	Bandscheibenstanze, COLCLOUGH.....	286	CASPAR, Distraktor.....	158
ADLERKREUTZ, Gefäßpinzette.....	54	Bandscheibenstanze, FERRIS-SMITH-KERRISON.....	282 - 285	CASPAR, Einsetzinstrument.....	194
ADSON, anatomische Pinzette.....	51	BANE-HARTMANN, Hohlmeißelzange.....	164	CASPAR, Explorationshäkchen.....	115
ADSON, Bohrlochzange.....	181	BARRON, Saugrohr.....	231	CASPAR, Fadengabel.....	253
ADSON, chirurgische Pinzette.....	51, 52	BARRAQUER, Nadelhalter.....	96	CASPAR, Gegensperrerr.....	156
ADSON, Dura-Haken.....	110	BAUMGARTNER, Nadelhalter.....	94	CASPAR, Haken.....	136
ADSON, Hohlmeißelzange.....	163	BECKMANN, Wundspreizer.....	132	CASPAR, Knochenspanhalter.....	194
ADSON, Hypophyse-Pinzette.....	261	BECKMANN-ADSON (CONE), Wundspreizer.....	126	CASPAR, Koagulationshäkchen.....	115
ADSON, Raspatorium.....	218	BECKMANN-ADSON, Wundspreizer.....	130	CASPAR, Laminektomie-Spreizer.....	136
ADSON, Saugrohr.....	230	BECKMANN-EATON, Wundspreizer.....	132	CASPAR, Laminektomie-Zange.....	242, 243
ADSON, Wundspreizer.....	125, 126, 129	BERCHTOLD, Bipolar-Verbindungskabel.....	335	CASPAR, Lumbal-Wundspreizer.....	154, 156
ADSON-BABY, Arterienklemme.....	88	BERLINER, Perkussionshammer.....	8	CASPAR, Mikro-Dissektor.....	227, 228
ADSON-BROWN, chirurgische Pinzette.....	52	BEYER, Hohlmeißelzange.....	165, 167	CASPAR, Nervwurzelhaken.....	112
ADSON-De BAKEY, Atrauma-Pinzette.....	51	BIEMER, Anlegepinzette.....	306, 311	CASPAR, Skalpellgriff.....	16
AESCULAP, Bipolar-Verbindungskabel.....	335	BIEMER, Approximator.....	311	CASPAR, Spekula.....	155
ALEXANDER, Raspatorium.....	210	BIEMER, Gefäßclip.....	306	CASPAR, Stößel.....	195
ALM, Wundspreizer.....	120	BIEMER, Gefäßspreizer.....	250	CASTROVIEJO, Hornhautschere.....	36
Anatomische Mikro-Pinzette.....	56	BIEMER, Nerv-Approximator.....	312	CASTROVIEJO, Klingenspreizer.....	17
Anatomische Pinzette, ADSON.....	51	BIEMER, Venenschere.....	44, 45	CASTROVIEJO, Nadelhalter.....	97
Anatomische Pinzette, BROPHY.....	54	BIEMER-MÜLLER, Approximator.....	308	Cervicalgewebespreizer, CLOWARD.....	153
Anatomische Pinzette, CUSHING.....	53	Biopsie-Bohrer, MICHELE.....	182	Chirurgische Pinzette, ADSON.....	51, 52
Anatomische Pinzette, DUEHRSEN.....	55	Bipolare Pinzette.....	328 - 331	Chirurgische Pinzette, BROPHY.....	54
Anatomische Pinzette, GERALD.....	56, 57	Bipolare Saugpinzette.....	334	Chirurgische Pinzette, CUSHING.....	53
Anatomische Pinzette, Mc INDOE.....	55	Bipolares Verbindungskabel.....	335	Chirurgische Pinzette, GERALD.....	57
Anatomische Pinzette, POTTS-SMITH.....	50	Bipolar-Pinzette, Antihaft.....	332, 333	Chirurgische Pinzette, GILLIES.....	56
Anatomische Pinzette, SEMKEN.....	56	BLACK, Präparierschere.....	25	Chirurgische Pinzette, Mc INDOE.....	55
Anatomische Pinzette, TAYLOR.....	58	Blätter, CASPAR.....	136	Chirurgische Pinzette, POTTS-SMITH.....	50
ANDERSON-ADSON, Wundspreizer.....	128	Blätter, medial, lateral.....	146	Chirurgische Pinzette, SEMKEN.....	56
Aneurysmen-Gefäßclip, YASARGIL.....	294 - 301	Blätter, schwarz.....	154, 156, 157	Chirurgische Pinzette, TAYLOR.....	58
Anlegepinzette, ACLAND.....	318	Blätter, Titan.....	145, 146	Chirurgische Pinzette, WAUGH.....	53
Anlegepinzette, BIEMER.....	306, 311	Blätter-Wechselpinzette.....	144, 156	Chirurgische Pinzette, ADSON-BROWN.....	52
Anlegepinzette, MEHDORN.....	307	Blattretractor, CLOWARD.....	103	Chirurgische Schere, IRIS.....	27
Anlegezange f. Bulldogklemmen.....	83	BÖHLER, Hohlmeißelzange.....	167	Chirurgische Schere, Neuro.....	27
Anlegezange f. offene Chirurgie.....	319, 320	BÖHLER, Knochensplitterzange.....	172	Chirurgische Scheren, Standard.....	20
Anlegezange, Mc KENZIE.....	174	Bohrapparat, BUNELL.....	325	CITELLI, Stanze.....	288
Anlegezange, MINI.....	302 - 305	Bohrapparat, HUDSON.....	324	Clip-Anlegezange.....	319, 320
Anlegezange, OLIVECRONA-TOENNIS.....	174	Bohrapparat, KIRSCHNER.....	325	Clip, ACLAND.....	315 - 317
Anlegezange, SMITHWICK.....	174	Bohrapparat, MOORE.....	323	Clip, BIEMER.....	306
Anlegezange, STANDARD.....	302 - 305	Bohrapparat, RALK.....	326	Clip, MEHDORN.....	307
Anlegezange, SWEET.....	174	Bohrapparat, REDA.....	326	Clip, MÜLLER.....	310, 311
Antihaft Bipolarpinzette.....	332, 333	Bohrapparat, STILLE.....	322	CLOWARD, Blattretractor.....	103
Approximator, BIEMER.....	311, 312	Bohrapparat, STILLE-SHERMAN.....	323	CLOWARD, Cervical-Spreizer.....	140 - 143
Approximator, BIEMER-MÜLLER.....	308	Bohrer.....	160	CLOWARD, Lamina-Spreizer.....	151, 153
Approximator, MÜLLER.....	309	Bohrer f. HUSON.....	324	CLOWARD, Laminektomie-Zange.....	239
Arterienklemme, ADSON-BABY.....	88	Bohrer f. MOORE.....	323	CLOWARD, Sperrerr.....	140 - 143
Arterienklemme, CRILE.....	85	Bohrer f. STILLE.....	322	CLOWARD, Wirbelkörper-Spreizer.....	153
Arterienklemme, CRILE-RANKIN.....	85	Bohrer f. STILLE-SHERMAN.....	323	COBB, Hohlmeißel.....	200
Arterienklemme, DANDY.....	86	Bohrer, CRUTCHFIELD.....	176	COBB, Kürette.....	185
Arterienklemme, FUCHSIG.....	88	Bohrer, CUSHING.....	324	COBB, Raspatorium.....	217
Arterienklemme, GEMINI.....	89	Bohrer, ERICCO.....	324	COLCLOUGH, Bandscheibenstanze.....	286
Arterienklemme, HALSTED-MOSQUITO.....	84	Bohrer, Mc KENZIE.....	324	CONE, Ringkürette.....	260
Arterienklemme, HARTMANN.....	83	Bohrer, MICHELE.....	182	CONE, Schädelstanze.....	179
Arterienklemme, JACOBSON.....	84	Bohrlehre.....	159	CONE, Wundspreizer.....	126
Arterienklemme, KELLY.....	85	Bohrloch-Schutzzange.....	180	Container f. Aneurysmenclips.....	313, 314
Arterienklemme, KELLY-RANKIN.....	85	Bohrlochzange, ADSON.....	181	COTTLE, Fixierpinzette.....	74
Arterienklemme, MIXTER-BABY.....	90	Bohrstütze f. KIRSCHNER.....	325	COTTLE, Osteotom.....	204
Atrauma-Bulldogklemme.....	80	BOIES, Elevatorium.....	211	COTTLE, Stahlhammer.....	10
Atrauma-Bulldogklemme, De BAKEY.....	80 - 82	BROPHY, anatomische Pinzette.....	54	COTTLE-KAZANJIAN, Knochensplitterzange.....	172
Atrauma-Bulldogklemme, De BAKEY (CAROTID).....	82	BROPHY, chirurgische Pinzette.....	54	CRILE, Arterienklemme.....	85
Atrauma-Bulldogklemme, De BAKEY (SATINSKY).....	82	BROWN, Gewebefaßpinzette.....	53	CRILE, Nervhaken.....	109
Atrauma-Bulldogklemme, De BAKEY-HESS.....	82	BRUNS, scharfer Löffel.....	188	CRILE-RANKIN, Arterienklemme.....	85
Atrauma-Bulldogklemme, GLOVER.....	80, 81	BUCK, Perkussionshammer.....	80	CRILE-WOOD, Nadelhalter.....	94
Atrauma-Bulldogklemme, Titan.....	79	Bulldogklemme, atrauma.....	80	CRUTCHFIELD, Bohrer.....	176
Atrauma-Mikro-Pinzette, De BAKEY.....	67, 68	Bulldogklemme, De BAKEY (CAROTID), atrauma.....	82	CRUTCHFIELD, Schädelhalter.....	176
Atrauma-Pinzette, ADSON-De BAKEY.....	51	Bulldogklemme, De BAKEY (SATINSKY), atrauma.....	82	CUSHING (LITTLE-JOKER), Raspatorium.....	207
Atrauma-Pinzette, De BAKEY.....	69	Bulldogklemme, De BAKEY, atrauma.....	80 - 82	CUSHING (TAYLOR) anatomische Pinzette.....	57
Atrauma-Ultra-Light-Pinzette.....	65	Bulldogklemme, De BAKEY-DIETRICH.....	78	CUSHING, anatomische Pinzette.....	53
AUSTIN, Mikro-Knüpfpinzette.....	64	Bulldogklemme, De BAKEY-HESS, atrauma.....	82	CUSHING, chirurgische Pinzette.....	53
		Bulldogklemme, DIEFFENBACH.....	83	CUSHING, Flachbohrer.....	324
		Bulldogklemme, DIETRICH.....	78	CUSHING, Hirnspatel.....	274, 279
		Bulldogklemme, GLOVER, atrauma.....	80, 81	CUSHING, Laminektomie-Zange.....	238
		Bulldogklemme, JOHNS-HOPKINS.....	83	CUSHING, Nervhaken.....	109
		Bulldogklemme, Titan, atrauma.....	79	CUSHING, Raspatorium.....	208
		BUNELL, Handbohrapparat.....	325	CUSHING, Wundhaken.....	103
		BUSHE, scharfer Löffel.....	191	CUSHING-LANDOLT, Spekula.....	263

D		E		G
DANDY, Arterienklemme	86	ECHLIN, Hohlmeißelzange	171	Galeahaken, YASARGIL
DANDY, Nervhaken	108	Einsetzinstrument, CASPAR	194	GALT, Schädeltrephine
De DANDY, Trigemini-Schere	33	Elevator m. Hohlheft	213	Gefäßclip, ACLAND
DARLING, Hemilanektomie-Spreizer	147	Elevatorium, BOIES	211	Gefäßclip, BIEMER
DAUBENSPECK, scharfer Löffel	189	Elevatorium, Ferrozellgriff	215, 216	Gefäßclip, MEHDORN
DAVIS, Dura-Dissektor	221, 222	Elevatorium, FREER	220	Gefäßclip, YASARGIL
DAVIS, Hirnspatel	275	Elevatorium, JOSEPH	219	Gefäßclip, MÜLLER
De BAKEY (CAROTID), Atrauma-Bulldogklemme	82	Elevatorium, KEY	218	Gefäßdilator
De BAKEY (SATINSKY) Atrauma-Bulldogklemme	82	Elevatorium, Mc DONALD	219	Gefäßmesser, JACOBSON
De BAKEY, Atrauma-Bulldogklemme	80 - 82	Elevatorium, QUERVAIN	208	Gefäßmesser, KOOS
De BAKEY, Atrauma-Mikro-Pinzette	67, 68	Elevatorium, ROGER	220	Gefäßmesser, Mikro
De BAKEY, Atrauma-Pinzette	69	Elevatorium, SEBILEAU	208	Gefäßmesser, YASARGIL
De BAKEY, Gefäßschere	30 - 32	Elevatorium, SEWALL	219	Gefäßpinzette, ADLERKREUZ
De BAKEY, Nadelhalter TC	95	Elevatorium, WATSON-CHEYNE	219	Gefäßpinzette, WANGENSTEIN
De BAKEY-DIETRICH, Atrauma-Bulldogklemme	78	Enukleator, HARDY	266	Gefäßschere, De Bakey
De BAKEY-HESS, Atrauma-Bulldogklemme	82	Enukleator, LANDOLT	267	Gefäßschere, DIETRICH
De MARTEL, Führungsinstrument	177	ERBE, Bipolar-Verbindungskabel	335	Gefäßschere, FAVALORO
De VILBISS, Schädelzange	178	ERRICO, Bohrer	324	Gefäßschere, KELLY
DEAVER, Präparierschere	21	Ersatzbacken	9, 10	Gefäßschere, MILLS
DEJERINE, Perkussionshammer	8	Ersatz-Nadeln f. Approximator	312	Gefäßschere, POTTS-De MARTEL
D'ERRICO, Nervwundhaken	113	Ersatzschlüssel f. Approximator	312	Gefäßschere, POTTS-SMITH
Diamantiert, Ringpinzette	66	Explorationshäkchen, CASPAR	115	Gefäßspreizer, BIEMER
DIEFFENBACH, Bulldogklemme	83			Gegenspreizer, CASPAR
DIETRICH, Gefäßschere	29, 30	F		Gelenkkloben, LEYLA
DIETRICH, Mini-Bulldogklemme	78	Fadenführer, YASARGIL	116	GELPI, Wundspreizer
Dilatator	61	Fadengabel, CASPAR	253	GEMINI, Arterienklemme
Dilatator, Gefäß	250	Fadengabel, JACOBSON	253	GERALD, anatomische Pinzette
Dissektor	222	FAHLBUSCH, Kürette	270	GERALD, chirurgische Pinzette
Dissektor, CASPAR	227, 228	FAHLBUSCH, Löffel	270	Gewebehaftpinzette, BROWN
Dissektor, DAVIS	221, 222	FAHLBUSCH, Mikro-Schere	271	Gewebekralle
Dissektor, FRAZIER	223	FARABEUF, Raspatorium	206	GIERTZ-STILLE, Rippenschere
Dissektor, GORNEY	211	FARABEUF-COLLIN, Raspatorium	206, 207	GIGLI, Drahtsäge-Handgriff
Dissektor, HARDY-FAHLBUSCH	266	Farbzange, MARTEL	87	GIGLI-STRULLY, Drahtsäge-Handgriff
Dissektor, HOEN	223	Farbzange, WILLET-MARTEL	87	GILLIES, chirurgische Pinzette
Dissektor, HORSLEY	222	Farbzange, YASARGIL-NICOLA	271	GILLIES, Hauthäkchen
Dissektor, LANDOLT-REULEN	270	FAVALORO, Gefäßschere	32	GLOVER, Atrauma-Bulldogklemme
Dissektor, MILLIGAN	227, 228	Federschere, Mikro	35, 38 - 45	GORNEY, Dissektor
Dissektor, OLIVECRONA	221	FERRIS-SMITH, Laminektomie-Zange	241	GRADLE, Ophthalmologie-Schere
Dissektor, PENFIELD	224	FERRIS-SMITH-KERRISON, Bandscheibenstanze	282 - 285	GRAHAM, Nervhaken
Dissektor, RHOTON	256	FISCH, Dura-Haken	249	Griff f. HUDSON
Dissektor, SACHS	221	FISCH, feines Häkchen	118	Griff mit Spannfutter
Dissektor, TOENNIS	221	Fixierpinzette, COTTLE	74	Griff, CASPAR
Dissektor, WOODSON	223	Fixiervorrichtung, LEYLA	276, 278, 279	Griff, LANDOLT
Distractionsschraube	160	Flachbohrer, CUSHING	324	Griff, LANDOLT
Distrikator, CASPAR	158	Flachmeißel, Ferrozellgriff	202	GUILLEN, Saugraspatorium
Doppellöffel, JANSEN	192	Flachmeißel, STILLE	196	
Doppellöffel, VOLKMANN	192	flexibler Spannarm, LEYLA	276, 278, 279	H
Doppelsonde, JACOBSON	249	flexibler Spannarm, YASARGIL	278	HAJEK-KOFLER, Stanze
DOYEN, Raspatorium	212, 213	FOMON, Raspatorium	211	Häkchen, auswechselbar
Drahtsäge, OLIVECRONA	177	Fräser f. HUDSON	324	Häkchen, CASPAR
Drahtsägegriff, GIGLI	177	Fräser f. STILLE	322	Häkchen, FISCH
Drahtsägegriff, GIGLI-STRULLY	177	FRAZIER, Dura-Dissektor	223	Häkchen, FRAZIER
Drahtsägegriff, REDA	177	FRAZIER, Hauthäkchen	102	Häkchen, FREER
Drahtsägegriff, STRULLY	177	FRAZIER, Saugrohr	230	Häkchen, GILLIES
Drahtschere, UNIVERSAL	34	FRAZIER/FERGUSSON, Punktionskanüle	231	Häkchen, JOSEPH
Dreh Schlüssel f. CASPAR	136	FRAZIER/FERGUSSON, Saugrohr	231	Häkchen, KRAYENBÜHL
DUEHRSEN, anatomische Pinzette	55	FREER, Hauthäkchen	102	Häkchen, LANDOLT
Dura-Dissektor	222	FREER, Septumlevator	220	Häkchen, LANDOLT-REULEN
Dura-Dissektor, DAVIS	221, 222	FRIEDMAN, Hohlmeißelzange	162	Häkchen, Mikro
Dura-Dissektor, FRAZIER	223	FRYKHOLM, Hohlmeißelzange	171	Häkchen, RHOTON
Dura-Dissektor, HOEN	223	FUCHSIG, Arterienklemme	88	Häkchen, RHOTON
Dura-Dissektor, HORSLEY	222	Führungsinstrument, De MARTEL	177	Haken, CUSHING
Dura-Dissektor, MILLIGAN	222			Haken, ADSON
Dura-Dissektor, OLIVECRONA	221			Haken, CASPAR
Dura-Dissektor, SACHS	221			Haken, CRILE
Dura-Dissektor, TOENNIS	221			Haken, CUSHING
Dura-Dissektor, WOODSON	223			Haken, DANDY
Dura-Haken, ADSON	110			Haken, D'ERRICO
Dura-Haken, FISCH	249			Haken, FISCH
Dura-Schere, SCHMIEDEN-TAYLOR	34			Haken, GRAHAM
				Haken, HESS
				Haken, HOLLSHER
				Haken, KOCHER
				Haken, KOCHER-LANGENBECK
				Haken, LANGENBECK
				Haken, LOVE
				Haken, MEYERDING
				Haken, SACHS
				Haken, SCOVILLE
				Haken, SMITHWICK
				Haken, TAYLOR

HALLE, scharfer Löffel.....	186	Hohlmeißelzange, MICRO FRIEDMAN.....	162	Klemme, CRILE.....	85
HALSEY, Nadelhalter.....	94	Hohlmeißelzange, OLIVECRONA.....	164	Klemme, CRILE-RANKIN.....	85
HALSTED-MOSQUITO, Arterienklemme.....	84	Hohlmeißelzange, RUSKIN.....	168	Klemme, DANDY.....	86
Haltearm, LEYLA.....	279, 280	Hohlmeißelzange, SAUERBRUCH.....	170	Klemme, FUCHSIG.....	86
Halter, CASPAR.....	194	Hohlmeißelzange, SEMB.....	171	Klemme, GEMINI.....	89
Hammer.....	9, 10	Hohlmeißelzange, SMITH-PETERSON.....	166	Klemme, HALSTED-MOSQUITO.....	84
Hammer, BABINSKY.....	8	Hohlmeißelzange, STELLBRINK.....	162	Klemme, HARTMANN.....	83
Hammer, BERLINER.....	8	Hohlmeißelzange, STILLE-LUER.....	169	Klemme, JACOBSON.....	84
Hammer, BUCK.....	8	Hohlmeißelzange, STILLE-RUSKIN.....	169	Klemme, KELLY.....	85
Hammer, COTTLE.....	10	Hohlmeißelzange, ZAUFAL-JANSEN.....	167	Klemme, KELLY-RANKIN.....	85
Hammer, DEJERINE.....	8	HOLSHER, Nervwurzelhaken.....	111	Klemme, MIXTER-BABY.....	90
Hammer, OMBREDANNE.....	10	HOLZHEIMER, Wundsperrer.....	120	Klingenbrecher, CASTROVIEJO.....	17
Hammer, TAYLOR.....	8	Hornhautschere, CASTROVIEJO.....	36	Klingenbrecher, REDA.....	17
Hammer, TROEMMER.....	8	HORSLEY, Dura-Dissektor.....	222	Klingenbrecher, TROUTMAN-CHRIS.....	17
Hammer, WAGNER.....	10	HOSOBUCHI, Spatel.....	267	KNIGHTON, Wundspreizer.....	134
Hammer, WILLIGER.....	9	HOUSE, Saugadapter.....	231	Knochenspanhalter, CASPAR.....	194
Handbohrapparat, BUNELL.....	325	HOUSE, Saugrohr.....	233	Knochen splitterzange, BÖHLER.....	172
Handbohrapparat, HUDSON.....	324	HUDSON, Handbohrapparat.....	324	Knochen splitterzange, COTTLE-KAZANJIAN.....	172
Handbohrapparat, KIRSCHNER.....	325	HUNT, Tumorzpinzette.....	70, 71	Knochen splitterzange, LISTON.....	172
Handbohrapparat, MOORE.....	323	Hypophyse-Kürette, HARDY.....	268	Knochen splitterzange, Mc INDOE.....	172
Handbohrapparat, RALK.....	326	Hypophyse-Kürette, RAY.....	262	Knochen splitterzange, RUSKIN-LISTON.....	172
Handbohrapparat, REDA.....	326	Hypophyse-Löffel, HARDY.....	269	Knochen splitterzange, SEMB.....	173
Handbohrapparat, STILLE.....	322	Hypophyse-Mikro-Schere.....	272	Knochen splitterzange, STAMM.....	172
Handbohrapparat, STILLE-SHERMAN.....	323	Hypophyse-Löffelzange.....	272	Knochen splitterzange, STILLE-HORSLEY.....	173
Handgriff, GIGLI.....	177	Hypophyse-Mikro-Zange.....	272	Knochen splitterzange, STILLE-LISTON.....	173
Handgriff, GIGLI-STRULLY.....	177	Hypophyse-Pinzette, ADSON.....	261	Knopfsonde, JACOBSON.....	249
Handgriff, REDA.....	177	Hypophyse-Zange, LANDOLT.....	245	Knopfsonde, RHOTON.....	256
Handgriff, STRULLY.....	177	Hypophyse-Zange, NICOLA.....	271	Knüppelzange, Mikro.....	62, 64
Handgriff, WULLSTEIN.....	234	Hypophyse-Zange, OLDBERG.....	245	Koagulationshäkchen, CASPAR.....	115
HARDY, Eukleator.....	266	Hypophyse-Zange, YASARGIL.....	245	KOCHER, Wundhaken.....	104, 105
HARDY, Hypophyse-Kürette.....	268			KOCHER-LANGENBECK, Wundhaken.....	104
HARDY, Hypophyse-Löffel.....	269	I		KOENIG, Rasperatorium.....	210
HARDY, Implantationsgabel.....	266	Implantationsgabel, HARDY.....	266	KOOS, Mikro-Gefäßmesser.....	248, 249
HARDY, Mikrospiegel.....	269	INGE, Lamina-Spreizer.....	152	Kopfhautklammer, RANEY.....	176
HARDY-FAHLBUSCH, Dissektor.....	266	IRIS, feine Schere.....	27	Kopfhautspreizer, SCALP-CONTOUR.....	127
HARTMANN, Arterienklemme.....	83			Kralle, Gewebe.....	255
HARVEY-JACKSON, Wundspreizer.....	133	J		KRAYENBÜHL, Nervhäkchen.....	116
Hauthäkchen, FRAZIER.....	102	JACOBSON, Doppelsonde.....	249	Kugelgelenkkloben, LEYLA.....	279, 280
Hauthäkchen, FREER.....	102	JACOBSON, Fadengabel.....	253	Kunststoffbacken f. Hammer.....	10
Hauthäkchen, GILLIES.....	102	JACOBSON, Gefäßmesser.....	117, 118	Kupplungskopf, LEYLA.....	279, 280
Hauthäkchen, JOSEPH.....	102	JACOBSON, Knopfsonde.....	249	Kürette, COBB.....	185
HEIFETZ, Hirnspatel.....	275	JACOBSON, Mikro-Arterienklemme.....	84	Kürette, CONE.....	260
HEIFETZ, Tumorzpinzette.....	147	JACOBSON, Mikro-Federschere.....	44, 45	Kürette, FAHLBUSCH.....	270
Hemilaminektomie-Spreizer, DARLING.....	127	JAMESON-WERBER, Präparierschere.....	26	Kürette, HARDY.....	268
HENLEY, Retraktor.....	123	JANSEN, Hohlmeißelzange.....	164	Kürette, LANDOLT.....	267
HENLEY, Wundspreizer.....	123	JANSEN, Ohrpinzette.....	74	Kürette, LANDOLT-REULEN.....	270
HESS, Nervhaken.....	111	JANSEN, Rasperatorium.....	206	Kürette, NICOLA.....	265
Hirnspatel, AACHEN.....	274	JANSEN, scharfer Doppellöffel.....	192	Kürette, RAY.....	262
Hirnspatel, CUSHING.....	274, 279	JANSEN, Wundspreizer.....	120		
Hirnspatel, DAVIS.....	275	JANSEN-GRUENWALD, Ohrpinzette.....	74	L	
Hirnspatel, HEIFETZ.....	275	JOHNS-HOPKINS, Bulldogklemme.....	83	Lagerungscontainer.....	313, 314
Hirnspatel, OLIVECRONA.....	274	JOSEPH, Hauthäkchen.....	102	LAMBOTTE, Osteotom.....	198
Hirnspatelhalter, LEYLA.....	276, 277	JOSEPH, Rasperatorium.....	211	LAMBOTTE, Rasperatorium.....	207
Hirnspatelhalter, YASARGIL.....	276	JOSEPH, Septumlevator.....	219	Laminektomie-Spreizer, BADGLEY.....	139
Hirnspatelpinzette, SCOVILLE.....	59	Juwelierpinzette.....	60, 61	Laminektomie-Spreizer, CASPAR.....	136
HOEN, Dura-Dissektor.....	223			Laminektomie-Spreizer, SCOVILLE.....	137
HOEN, Laminektomie-Zange.....	240	K		Laminektomie-Spreizer, SCOVILLE-HAVERFIELD.....	137
HOEN, Rasperatorium.....	209	Kabel, AESCULAP, Bipolar.....	335	Laminektomie-Spreizer, SCOVILLE-RICHTER.....	138
Hohlmeißel, COBB.....	200	Kabel, BERCHTOLD, Bipolar.....	335	Laminektomie-Wundspreizer.....	131
Hohlmeißel, Ferrozellgriff.....	202	Kabel, Bipolar.....	335	Laminektomie-Zange, CASPAR.....	242, 243
Hohlmeißel, LEXER.....	201	Kabel, ERBE, Bipolar.....	335	Laminektomie-Zange, CLOWARD.....	239
Hohlmeißel, LEXER MINI.....	201	Kabel, MARTIN, Bipolar.....	335	Laminektomie-Zange, CUSHING.....	238
Hohlmeißel, NOVOTEX-Griff.....	203	Kabel, SELECT, Bipolar.....	335	Laminektomie-Zange, FERRIS-SMITH.....	241
Hohlmeißel, SMITH-PETERSON.....	197	Kabel, STORZ, Bipolar.....	335	Laminektomie-Zange, HOEN.....	240
Hohlmeißel, STILLE.....	196	Kabel, USA Mod., Bipolar.....	335	Laminektomie-Zange, LOVE-GRUENWALD.....	238
Hohlmeißel, ZIELKE.....	202	Kanüle, FRAZIER/FERGUSSON.....	231	Laminektomie-Zange, SCHLESINGER.....	239
Hohlmeißelzange, ADSON.....	163	Kanüle, Mikro.....	232	Laminektomie-Zange, SPURLING.....	238
Hohlmeißelzange, BACON.....	166	KELLY, Arterienklemme.....	85	Laminektomie-Zange, WAGNER.....	241
Hohlmeißelzange, BANE-HARTMANN.....	164	KELLY, Gefäßschere.....	21	Laminektomie-Zange, WEIL-BLAKESLEY.....	244
Hohlmeißelzange, BEYER.....	165, 167	KELLY-RANKIN, Arterienklemme.....	85	LANDOLT, Eukleator.....	267
Hohlmeißelzange, BÖHLER.....	167	KERRISON, Stanze.....	287	LANDOLT, Häkchen.....	267
Hohlmeißelzange, ECHLIN.....	171	KEY, Elevatorium.....	218	LANDOLT, Hypophyse-Zange.....	245
Hohlmeißelzange, FRYKHOLM.....	171	KILNER, Präparierschere.....	26	LANDOLT, Kürette.....	267
Hohlmeißelzange, JANSEN.....	164	KIRSCHNER, Handbohrapparat.....	325	LANDOLT, Löffel.....	267
Hohlmeißelzange, KLEINERT-KUTZ.....	165	Klammer, RANEY.....	176	LANDOLT, Pinzette.....	264
Hohlmeißelzange, LEKSELL (STILLE).....	170	Klammeranlagezange, RANEY.....	176	LANDOLT, Skalpelgriff.....	16
Hohlmeißelzange, LEMPERS.....	164, 165	Klammerblock.....	174	LANDOLT, Spreizzange.....	263
Hohlmeißelzange, LUER.....	163	Klammerhalter.....	174	LANDOLT, Tumor-Faßzange.....	245
Hohlmeißelzange, MARQUARD.....	168	KLEINERT-KUTZ, Hohlmeißelzange.....	165	LANDOLT-REULEN, Dissektor.....	270
Hohlmeißelzange, MAYFIELD.....	167	Klemme, ADSON-BABY.....	88	LANDOLT-REULEN, Häkchen.....	270

LANDOLT-REULEN, Kürette270
 LANDOLT-REULEN, Raspatorium270
 LANGENBECK, Raspatorium209
 LANGENBECK, Wundhaken104, 105
 Lanzettenmesser, SAMIL252
 LAZAR, Mikro-Knüpppinzette63
 LEKSELL (STILLE), Hohlmeißelzange170
 LEMPERS, Hohlmeißelzange164, 165
 LEMPERS, scharfer Löffel190
 LEXER MINI, Hohlmeißel201
 LEXER MINI, Osteotom201
 LEXER, Hohlmeißel201
 LEXER, Osteotom201
 LEXER, Präparierschere22
 LEYLA, Fixiervorrichtung276, 278, 279
 LEYLA, flexibler Spannarml276, 278, 279
 LEYLA, Haltearm279, 280
 LEYLA, Hirnspatelhalter276, 277
 LEYLA, Kugelgelenkkloben279, 280
 LEYLA, Kupplungskopf279, 280
 LEYLA, Ohrspekulahalter278
 LEYLA, Ohrtrichterhalter278
 LEYLA, Retraktor-System279
 LEYLA, Spatelhalter276, 279
 LISTON, Knochensplitterzange172
 LITTLE-JOKER, Raspatorium207
 Löffel COBB185
 Löffel BRUNS188
 Löffel BUSHE191
 Löffel DAUBENSPECK189
 Löffel FAHLBUSCH270
 Löffel, Ferrozellgriff189
 Löffel HALLE186
 Löffel HARDY269
 Löffel JANSEN192
 Löffel LANDOLT267
 Löffel LEMPERS190
 Löffel Mikro193
 Löffel REDA190, 191
 Löffel RHOTON256
 Löffel SCOVILLE187
 Löffel SPINAL186, 187
 Löffel SPRATT184
 Löffel VOLKMANN184, 192
 Löffel YASARGIL193
 Löffelzange, Hypophyse272
 LOVE, Nervwurzelhaken113, 114
 LOVE-GRUENWALD, Laminektomie-Zange238
 LUCAE, Ohrpinzette74
 LUER, Hohlmeißelzange163

M
 MARKHAM-MEYERDING, Hemilaminektomie-Spreizer148
 MARQUARD, Hohlmeißelzange168
 MARTEL, Faßzange87
 MARTIN, Bipolar-Verbindungskabel335
 Maßband, Stahl11
 Maßstab, Metall11
 MATSON, Raspatorium214
 MATSON-ALEXANDER, Raspatorium214
 MAYFIELD, Hohlmeißelzange167
 MAYO, Pinzette58
 MAYO, Präparierschere22
 MAYO-ADAMS, Wundspreizer124
 MAYO-HEGAR, Nadelhalter95
 MAYO-STILLE, Präparierschere22
 Mc DONALD, Elevatorium219
 Mc INDOE, anatomische Pinzette55
 Mc INDOE, Knochensplitterzange172
 Mc KENZIE, Anlegezange174
 Mc KENZIE, Bohrer324
 Mc INDOE, chirurgische Pinzette55
 MEHDORN, Anlegepinzette307
 MEHDORN, Gefäßclip307
 Meißel, COBB200
 Meißel, Ferrozellgriff202
 Meißel, LEXER201
 Meißel, LEXER MINI201
 Meißel, NOVOTEX-Griff203
 Meißel, SMITH-PETERSON197

Meißel, STILLE196
 Meißel, Wirbelsäule203
 Meißel, ZIELKE202
 MESSER, JACOBSON117, 118
 Messer, SAMIL251, 252
 Meßschieber11
 Metall, Maßstab11
 Metallbacken f. Hammer10
 METZENBAUM, Präparierschere23
 METZENBAUM-BLACK, Präparierschere24, 25
 METZENBAUM-FINO, Präparierschere23
 MEYERDING, Hemilaminektomie-Spreizer148
 MEYERDING, Wundhaken106
 MICHELE, Biopsie-Bohrer182
 Mikro-Federschere, YASARGIL41, 42, 45
 Mikro-Clip, ACLAND315 - 317
 Mikro-Dissektor227, 228
 Mikro-Dissektor, CASPAR227, 228
 Mikro-Federschere38, 45
 Mikro-Federschere, JACOBSON44, 45
 Mikro-Federschere, MILLESI44, 45
 Mikro-Federschere, NAGEL43
 Mikro-Federschere, POTTS-YASARGIL44, 45
 Mikro-Federschere, Rundgriff46
 Mikro-Federschere, VANNAS37, 42, 44, 45
 Mikro-Gefäßmesser118
 Mikro-Gefäßmesser, KOOS248, 249
 Mikro-Gefäßmesser, YASARGIL248
 Mikro-Häkchen118
 Mikro-Kanülen232
 Mikro-Knüpppinzette62, 64
 Mikro-Knüpppinzette, AUSTIN64
 Mikro-Knüpppinzette, LAZAR63
 Mikro-Knüpppinzette, VISE64
 Mikro-Löffel193
 Mikro-Löffel, YASARGIL193
 Mikro-Nadelhalter99, 100
 Mikro-Pinzette, anatomisch56
 Mikro-Pinzette, YASARGIL75
 Mikro-Präparierschere, Rundgriff46
 Mikro-Raspatorium, YASARGIL225 - 227
 Mikro-Ringpinzette66
 Mikro-Ringpinzette, diamantiert66
 Mikro-Ringpinzette, Titan66
 Mikro-Saugkanülen f. WULLSTEIN234
 Mikro-Schere, FAHLBUSCH271
 Mikro-Schere, Hypophyse272
 Mikro-Schere, NICOLA271
 Mikro-Schere, Titan38 - 40
 Mikro-Spiegel, HARDY269
 Mikro-Zange, Hypophyse272
 MILLESI, Mikro-Federschere44, 45
 MULLIGAN, Dura-Dissektor222
 MILLS, Gefäßschere29
 Mini-Bulldogklemme, atrauma, De BAKEY-DIETRICH78
 Mini-Bulldogklemme, DIETRICH78
 MINI-LAMBOTTE, Osteotom199
 MISKIMOM, Wundspreizer128
 MIXTER-BABY, Arterienklemme90
 MOLLISON, Wundspreizer122
 MOLT, Raspatorium210
 MOORE, Handbohrapparat323
 MÜLLER, Approximator309
 MÜLLER, Gefäßclip310, 311

N
 Nadel, RHOTON256
 Nadelhalter TC, De BAKEY95
 Nadelhalter TC, RYDER95
 Nadelhalter, BARRAQUER96
 Nadelhalter, BAUNGARTNER94
 Nadelhalter, CASTROVIEJO97
 Nadelhalter, CRILE-WOOD94
 Nadelhalter, HALSEY94
 Nadelhalter, MAYO-HEGAR95
 Nadelhalter, Mikro99, 100
 Nadelhalter, NEIVERT94
 Nadelhalter, YASARGIL, Mikro98
 Nadeln f. Approximator312
 NAGEL, Mikro-Federschere43
 NEIVERT, Nadelhalter94
 Nerv-Approximator, BIEMER312
 Nervhäkchen, KRAYENBÜHL116
 Nervhaken, CRILE109
 Nervhaken, CUSHING109
 Nervhaken, DANDY108
 Nervhaken, GRAHAM110
 Nervhaken, SACHS110
 Nervhaken, SMITHWICK110
 Nervrädchen, WARTENBERG111
 Nervwundhaken, D'ERRICO113
 Nervwurzelhaken, CASPAR112
 Nervwurzelhaken, HESS111
 Nervwurzelhaken, HOLSHER111
 Nervwurzelhaken, LOVE113, 114
 Nervwurzelhaken, SCOVILLE111, 114
 Neuro, chirurgische Schere27
 Neuro, Stimmgabel11
 Neurochirurgie-Schere, STRULLY33
 NICOLA, Hypophyse-Zange271
 NICOLA, Kürette265
 NICOLA, Mikro-Schere271
 NICOLA, Raspatorium265
 NORFOLK/NORWICH, Wundspreizer124
 NOVOTEX-Griff, Hohlmeißel203

O
 Ohrpinzette, JANSEN74
 Ohrpinzette, JANSEN-GRUENWALD74
 Ohrpinzette, LUCAE74
 Ohrspekulahalter, LEYLA278
 Ohrspekulahalter, YASARGIL278
 Ohrtrichterhalter, LEYLA278
 OKONEK-YASARGIL, Tumorgabel254
 OLDBERG, Hypophyse-Zange245
 OLIVECRONA, Drahtsäge177
 OLIVECRONA, Dura-Dissektor221
 OLIVECRONA, Hirnspatel274
 OLIVECRONA, Hohlmeißelzange164
 OLIVECRONA, Trigenimus-Schere33
 OLIVECRONA-TOENNIS, Anlegezange174
 OMBREDANNE, Stahlhammer10
 Ophthalmologie-Schere28
 Ophthalmologie-Schere, GRADLE28
 Ophthalmologie-Schere, STEVENS28
 Osteotom, COTTLE204
 Osteotom, LAMBOTTE198
 Osteotom, LEXER201
 Osteotom, LEXER MINI201
 Osteotom, MINI-LAMBOTTE199
 Osteotom, SMITH-PETERSON197
 Osteotom, STILLE196

P
 PAPAVERO-CASPAR, Spekula264
 PAPAVERO-HARTMANN, Spreizer264
 PENFIELD, Dissektor224
 Perkussionshammer, BABINSKY8
 Perkussionshammer, BERLINER8
 Perkussionshammer, BUCK8
 Perkussionshammer, DEJERINE8
 Perkussionshammer, TAYLOR8
 Perkussionshammer, TROEMMER8
 Pinzette f. Blätter144, 156
 Pinzette, ACLAND318

Pinzette, ADLERKREUZ.....	54
Pinzette, ADSON.....	51, 261
Pinzette, ADSON-BROWN.....	52
Pinzette, ADSON-De BAKEY.....	51
Pinzette, atrauma.....	65
Pinzette, AUSTIN.....	64
Pinzette, BIEMER.....	306, 311
Pinzette, Bipolar.....	328 - 331, 334
Pinzette, Bipolar, Antihaft.....	332, 333
Pinzette, BROPHY.....	54
Pinzette, BROWN.....	53
Pinzette, COTTLE.....	74
Pinzette, CUSHING.....	53
Pinzette, CUSHING (TAYLOR).....	57
Pinzette, diamantiert.....	66
Pinzette, DUEHRSEN.....	55
Pinzette, GERALD.....	56, 57
Pinzette, GILLIES.....	56
Pinzette, HEIFETZ.....	72
Pinzette, HUNT.....	70, 71
Pinzette, JANSEN.....	74
Pinzette, JANSEN-GRUENWALD.....	74
Pinzette, LANDOLT.....	264
Pinzette, LAZAR.....	63
Pinzette, LUCAE.....	74
Pinzette, MAYO.....	58
Pinzette, Mc INDOE.....	55
Pinzette, MEHDORN.....	307
Pinzette, Mikro.....	66
Pinzette, POTTS-SMITH.....	50
Pinzette, SAMII.....	73
Pinzette, SCOVILLE.....	59
Pinzette, SEMKEN.....	56
Pinzette, TAYLOR.....	58
Pinzette, Titan.....	66
Pinzette, Tumor.....	70
Pinzette, Uhrmacher.....	60, 61
Pinzette, VISE.....	64
Pinzette, WANGENSTEEN.....	58
Pinzette, WAUGH.....	53
Pinzette, YASARGIL.....	70, 72, 75
Pinzette, YASARGIL-SAMII.....	72
PLESTER, Saugrohr.....	233
PLESTER, Wundspreizer.....	122, 124
POTTS-De MARTEL, Gefäßschere.....	29
POTTS-SMITH, anatomische Pinzette.....	50
POTTS-SMITH, chirurgische Pinzette.....	50
POTTS-SMITH, Gefäßschere.....	30, 31
POTTS-YASARGIL, Mikro-Federschere.....	44, 45
Präparierschere, BLACK.....	25
Präparierschere, DEEVER.....	21
Präparierschere, JAMESON-WERBER.....	26
Präparierschere, KILNER.....	26
Präparierschere, LEXER.....	22
Präparierschere, MAYO.....	22
Präparierschere, MAYO-STILLE.....	22
Präparierschere, METZENBAUM.....	23
Präparierschere, METZENBAUM-BLACK.....	24, 25
Präparierschere, METZENBAUM-FINO.....	23
Präparierschere, REYNOLDS.....	26
Präparierschere, TOENNIS-ADSON.....	27
Präparierschere, YASARGIL.....	42
Punktionkanüle, FRAZIER/FERGUSSON.....	231

Q

QUERVAIN, Elevatorium.....	208
----------------------------	-----

R

Rädchen, WARTENBERG.....	11
Rahmen, SCOVILLE-HAVERFIELD.....	137
Rahmen, SCOVILLE-RICHTER.....	138
RALK, Handbohrapparat.....	326
RANEY, Klammeranlegezange.....	176
RANEY, Kopfhautklammer.....	176
Rasporatorium, CUSHING.....	208
Rasporatorium, ADSON.....	218
Rasporatorium, ALEXANDER.....	210
Rasporatorium, COBB.....	217
Rasporatorium, CUSHING (LITTLE-JOKER).....	207
Rasporatorium, DOYEN.....	212, 213
Rasporatorium, FARABEUF.....	206
Rasporatorium, FARABEUF-COLLIN.....	206, 207
Rasporatorium, Ferrozellgriff.....	215, 216
Rasporatorium, FOMON.....	211
Rasporatorium, HOEN.....	209
Rasporatorium, JANSEN.....	206
Rasporatorium, JOSEPH.....	211
Rasporatorium, KOENIG.....	210
Rasporatorium, LAMBOTTE.....	207
Rasporatorium, LANDOLT-REULEN.....	270
Rasporatorium, LANGENBECK.....	209
Rasporatorium, LITTLE-JOKER.....	207
Rasporatorium, MATSON.....	214
Rasporatorium, MATSON-ALEXANDER.....	214
Rasporatorium, MOLT.....	210
Rasporatorium, NICOLA.....	265
Rasporatorium, RHOTON.....	256
Rasporatorium, SEDILLOT.....	207, 208
Rasporatorium, SELDIN.....	211
Rasporatorium, WAGNER.....	217
Rasporatorium, WILLINGER.....	210
Rasporatorium, YASARGIL.....	225 - 227
RAY, Hypophyse-Kürette.....	262
REDA, Drahtsäge-Handgriff.....	177
REDA, Handbohrapparat.....	326
REDA, Klingenbrecher.....	17
REDA, scharfer Löffel.....	190, 191
REDA, Retraktor, CLOWARD.....	103
REDA, Retraktor, HENLEY.....	123
Retraktor-System, LEYLA.....	279
REYNOLDS, Präparierschere.....	26
RHOTON, Dissektor.....	256
RHOTON, Häkchen.....	256
RHOTON, Knopfsonde.....	256
RHOTON, Nadel.....	256
RHOTON, Rasporatorium.....	256
RHOTON, scharfer Löffel.....	256
Ringkürette, CONE.....	260
Ringpinzette, Mikro.....	66
Rippenschere, GIERTZ-STILLE.....	48
Rippenschere, SAUERBRUCH.....	48
Rippenschere, SAUERBRUCH-FREY.....	48
ROGER, Septumellevator.....	220
Rundgriff, Mikro-Federschere.....	46
Rundgriff, Mikro-Präparierschere.....	46
RUSKIN, Hohlmeißelzange.....	168
RUSKIN-LISTON, Knochensplitterzange.....	172
RYDER, Nadelhalter TC.....	95

S

SACHS, Dura-Dissektor.....	221
SACHS, Nervhaken.....	110
SAMII, Lanzettenmesser.....	252
SAMII, Tumormesser.....	251, 252
SAMII, Tumorzange.....	73
SAUERBRUCH, Hohlmeißelzange.....	170
SAUERBRUCH, Rippenschere.....	48
SAUERBRUCH-FREY, Rippenschere.....	48
Saugadapter, HOUSE.....	231
Saughandgriff, WULLSTEIN.....	234
Saugkanüle, GUILLEN.....	235
Saugkanüle f. WULLSTEIN.....	234
Saugpinzette, Bipolar.....	334
Saugrasporatorium, GUILLEN.....	235
Saugrohr.....	232
Saugrohr, ADSON.....	230
Saugrohr, BARON.....	231

Saugrohr, FRAZIER.....	230
Saugrohr, FRAZIER/FERGUSSON.....	231
Saugrohr, HOUSE.....	233
Saugrohr, PLESTER.....	233
Saugrohr, SCHUHKNECHT.....	231
Saugrohr, WULLSTEIN.....	234
Saugrohr, YASARGIL.....	232
Saugrohr, ZÖLLNER.....	232
SCALP-CONTOUR, Kopfhautspreizer.....	127
Schädelhalter, CRUTCHFIELD.....	176
Schädelstanze, CONE.....	179
Schädeltrepheine, GALT.....	181
Schädelzange, De VILBISS.....	178
Scharfer Löffel, BRUNS.....	188
Scharfer Löffel, BUSHE.....	191
Scharfer Löffel, DAUBENSPECK.....	189
Scharfer Löffel, Ferrozellgriff.....	189
Scharfer Löffel, HALLE.....	186
Scharfer Löffel, LEMPERT.....	190
Scharfer Löffel, REDA.....	190, 191
Scharfer Löffel, SCOVILLE.....	187
Scharfer Löffel, SPINAL.....	186, 187
Scharfer Löffel, SPRATT.....	184
Scharfer Löffel, VOLKMAN.....	184
Schere, BIEMER.....	44, 45
Schere, BLACK.....	25
Schere, CASTROVIEJO.....	36
Schere, chirurgisch, STANDARD.....	20
Schere, DANDY.....	33
Schere, De BAKEY.....	30 - 32
Schere, DEEVER.....	21
Schere, DIETRICH.....	29, 30
Schere, FAHLBUSCH.....	271
Schere, FAVALORO.....	32
Schere, GIERTZ-STILLE.....	48
Schere, GRADLE.....	28
Schere, IRIS.....	27
Schere, JACOBSON.....	44, 45
Schere, JAMESON-WERBER.....	26
Schere, KELLY.....	21
Schere, KILNER.....	26
Schere, LEXER.....	22
Schere, MAYO.....	22
Schere, MAYO-STILLE.....	22
Schere, METZENBAUM.....	23
Schere, METZENBAUM-BLACK.....	24, 25
Schere, METZENBAUM-FINO.....	23
Schere, Mikro.....	35, 38 - 45
Schere, Mikro, Hypophyse.....	272
Schere, MILLES.....	44, 45
Schere, MILLS.....	29
Schere, NAGEL.....	43
Schere, Neuro.....	27
Schere, NICOLA.....	271
Schere, OLIVECRONA.....	33
Schere, Ophthalmologie.....	28
Schere, POTTS-De MARTEL.....	29
Schere, POTTS-SMITH.....	30, 31
Schere, POTTS-YASARGIL.....	44, 45
Schere, REYNOLDS.....	26
Schere, Rundgriff, Mikro.....	46
Schere, SAUERBRUCH.....	48
Schere, SAUERBRUCH-FREY.....	48
Schere, SCHMIEDEN-TAYLOR.....	34
Schere, STEVENS.....	28
Schere, STRULLY.....	33
Schere, Titan.....	38 - 40
Schere, TOENNIS-ADSON.....	27
Schere, Tumor.....	47
Schere, UNIVERSAL.....	34
Schere, VANNAS.....	37, 42, 44, 45
Schere, YASARGIL.....	41, 42, 45
Schere, Titan, Mikro.....	38 - 40
SCHLESINGER, Laminektomie-Zange.....	239
Schlüssel f. Approximator.....	312
Schlüssel f. BUNELL.....	325
Schlüssel f. CASPAR.....	136
Schlüssel f. Hammer.....	10
SCHMIEDEN-TAYLOR, Dura-Schere.....	34
Schraube, Distraction.....	160

Schraubendreher	160	Spreizer, MARKHAM-MEYERDING	148	Turnormesser, SAMII	251, 252
SCHUHKNECHT, Saugrohr	231	Spreizer, MAYO-ADAMS	124	Tumorzinzette	70
Schutzzange, Bohrloch	180	Spreizer, MEYERDING	148	Tumorzinzette, HEIFETZ	72
Schwarze Valve	154, 156, 157	Spreizer, MISKIMOM	128	Tumorzinzette, HUNT	70, 71
SCOVILLE, Haken	137	Spreizer, MOLLISON	122	Tumorzinzette, SAMII	73
SCOVILLE, Hirnspatelzinzette	59	Spreizer, NORFOLK/NORWICH	124	Tumorzinzette, YASARGIL	70, 72, 75
SCOVILLE, Laminektomie-Spreizer	137	Spreizer, PAPAVERO-HARTMANN	264	Tumorzinzette, YASARGIL-SAMII	72
SCOVILLE, Nervenzweihaken	111, 114	Spreizer, PLESTER	122, 124	Tumorschere	47
SCOVILLE, scharfer Löffel	187	Spreizer, SCALP-CONTOUR	127		
SCOVILLE, Valve	137	Spreizer, SCOVILLE	137	U	
SCOVILLE-HAVERFIELD, Laminektomie-Spreizer	137	Spreizer, SCOVILLE-HAVERFIELD	137	Uhrmacherzinzette	60, 61
SCOVILLE-HAVERFIELD, Rahmen	137	Spreizer, SCOVILLE-RICHTER	138	Ultra-Light-Pinzette, atrauma	65
SCOVILLE-RICHTER, Laminektomie-Spreizer	138	Spreizer, TRAVERS	125	UNIVERSAL, Drahtschere	34
SCOVILLE-RICHTER, Rahmen	138	Spreizer, WALTON	135	USA Mod., Bipolar-Verbindungskabel	335
SCOVILLE-RICHTER, Valven	138	Spreizer, WEITLANER	121		
SEBILEAU, Elevatorium	208	Spreizer, WEITLANER-WULLSTEIN	121	V	
SEDILOT, Raspatorium	207, 208	Spreizer, WILLIAMS	149	Valve, medial, lateral	146
Sehnenfaßzange, CAROLL	92	Spreizer, WULLSTEIN	122	Valve, SCOVILLE	137
SELDIN, Raspatorium	211	Spreizzange, LANDOLT	263	Valve, TAYLOR	137
SELECT, Bipolar-Verbindungskabel	335	SPURLING, Laminektomie-Zange	238	Valve	123
SEMB, Hohlmeißelzange	171	Stahl, Maßband	11	Valve, schwarz	154, 156, 157
SEMB, Knochensplitterzange	173	Stahlhammer, COTTLE	10	Valve, SCOVILLE-RICHTER	138
SEMKEN, anatomische Pinzette	56	Stahlhammer, OMBREDANNE	10	Valve, Titan	145, 146
SEMKEN, chirurgische Pinzette	56	Stahlhammer, WAGNER	10	VANNAS, Mikro-Federschere	37, 42, 44, 45
Septumelelevator, FREER	220	STAMM, Knochensplitterzange	172	Venenschere, BIEMER	44, 45
Septumelelevator, JOSEPH	219	STANDARD, chirurgische Scheren	20	Verbindungskabel, AESCULAP	335
Septumelelevator, ROGER	220	Stanze, CITELLI	288	Verbindungskabel, BERCHTOLD	335
SEWALL, Elevatorium	219	Stanze, COLCLOUGH	286	Verbindungskabel, Bipolar	335
Skalpelli Griff	14 - 16	Stanze, CONE	179	Verbindungskabel, ERBE	335
Skalpelli Griff, CASPAR	16	Stanze, FERRIS-SMITH-KERRISON	282 - 285	Verbindungskabel, MARTIN	335
Skalpelli Griff, LANDOLT	16	Stanze, HAJEK-KOFLER	287, 288	Verbindungskabel, SELECT	335
Skalpelli klingen	15	Stanze, KERRISON	287	Verbindungskabel, STORZ	335
SMITH-PETERSEN, Hohlmeißel	197	STELLBRINK, Hohlmeißelzange	162	Verbindungskabel, USA Mod.	335
SMITH-PETERSEN, Hohlmeißelzange	166	Sterilisiercontainer	313, 314	Verlängerungsstück f. HUSON	324
SMITH-PETERSEN, Osteotom	197	STEVENS, Ophtalmologie-Schere	28	WISE, Mikro-Knüpfpinzette	64
SMITHWICK, Anlegezange	174	STILLE, Flachmeißel	196	VOLKMANN, scharfer Doppellöffel	192
SMITHWICK, Nervhaken	110	STILLE, Handbohrapparat	322	VOLKMANN, scharfer Löffel	184
Sonde, JACOBSON	249	STILLE, Hohlmeißel	196		
Sonde, RHOTON	256	STILLE, Osteotom	196	W	
Spannschlüssel f. Bohrapparat	326	STILLE-HORSLEY, Knochensplitterzange	173	WAGNER, Laminektomie-Zange	241
Spatel, AACHEN	274	STILLE-LISTON, Knochensplitterzange	173	WAGNER, Raspatorium	217
Spatel, CUSHING	274, 279	STILLE-LUER, Hohlmeißelzange	169	WAGNER, Stahlhammer	10
Spatel, DAVIS	275	STILLE-RUSKIN, Hohlmeißelzange	169	WALTON, Wundspreizer	135
Spatel, HEIFETZ	275	STILLE-SHERMAN, Handbohrapparat	323	WANGENSTEEN, Gefäßpinzette	58
Spatel, HOSOBUCHI	267	Stimmgabel, Neuro	11	WARTENBERG, Nervdräthen	119
Spatel, OLIVECRONA	274	STORZ, Bipolar-Verbindungskabel	335	WATSON-CHEYNE, Elevatorium	219
Spatelhalter, LEYLA	276, 277, 279	Stößel, CASPAR	195	WAUGH, chirurgische Pinzette	53
Spatelhalter, YASARGIL	276	Stößel, Ferrozellgriff	195	Wechselpinzette f. Blätter	144, 156
Spekula, CASPAR	155	STRULLY, Drahtsäge-Handgriff	177	WEIL-BLAKESLEY, Laminektomie-Zange	244
Spekula, CUSHING-LANDOLT	263	STRULLY, Schere, Neurochirurgie	33	WEITLANER, Wundspreizer	121
Spekula, PAPAVERO-CASPAR	264	SWEET, Anlegezange	174	WEITLANER-WULLSTEIN, Wundspreizer	121
Spekulahalter, LEYLA	278			WILLET-MARTEL, Faßzange	87
Spekulahalter, YASARGIL	278	T		WILLIAMS, Hamilaminektomie-Spreizer	149
Sperner, CASPAR	156	TAYLOR, anatomische Pinzette	58	WILLIGER, Hammer	9
Sperner, CLOWARD	140 - 143	TAYLOR, chirurgische Pinzette	58	WILLIGER, Raspatorium	210
Spiegel, HARDY	269	TAYLOR, Perkussionshammer	8	Wirbelkörperspreizer, CLOWARD	151, 153
SPINAL, scharfer Löffel	186, 187	TAYLOR, Spinalhaken	107	Wirbelkörperspreizer, INGE	152
Spinalhaken, TAYLOR	107	TAYLOR, Valve	137	Wirbelsäulenmeißel	203
SPRATT, scharfer Löffel	184	Teleskop-Bohrdrahtstütze f. KIRSCHNER	325	WOODSON, Dura-Dissektor	223
Spreizer, ADSON	125, 126, 129	Teleskop-Stütze f. KIRSCHNER	325	WULLSTEIN, Saughandgriff	234
Spreizer, ALM	120	Titan, Ringpinzette	66	WULLSTEIN, Saugrohr	234
Spreizer, ANDERSON-ADSON	128	Titan, Schere	38 - 40	WULLSTEIN, Wundspreizer	122
Spreizer, BADGLEY	139	Titan-Atrauma-Bulldogklemme	79	Wundhaken, CUSHING	103
Spreizer, BECKMANN	132	Titan-Blätter	145, 146	Wundhaken, KOCHER	104, 105
Spreizer, BECKMANN-ADSON	130	Titan-Mikro-Schere	38 - 40	Wundhaken, KOCHER-LANGENBECK	104
Spreizer, BECKMANN-ADSON (CONE)	126	TOENNIS, Dura-Dissektor	221	Wundhaken, LANGENBECK	104, 105
Spreizer, BECKMANN-EATON	132	TOENNIS, Tumorfäßzange	91	Wundhaken, MEYERDING	106
Spreizer, BIEMER	250	TOENNIS-ADSON, Präparierschere	27	Wundsperrer, CLOWARD	140 - 143
Spreizer, CASPAR	136	TRAVERS, Wundspreizer	125	Wundsperrer, HOLZHEIMER	120
Spreizer, CLOWARD	140 - 143, 151, 153	Trepphine f. STILLE	322	Wundspreizer	131
Spreizer, CONE	126	Trepphine, GALT	181	Wundspreizer, ADSON	125, 126, 129
Spreizer, DARLING	147	Trepphine, MICHELE	182	Wundspreizer, ALM	120
Spreizer, GELPI	150	Trigeminus-Schere, DANDY	33	Wundspreizer, ANDERSON-ADSON	128, 130
Spreizer, HARVEY-JACKSON	133	Trigeminus-Schere, OLIVECRONA	33	Wundspreizer, BECKMANN	132
Spreizer, HENLEY	123	TROEMMER, Perkussionshammer	8	Wundspreizer, BECKMANN-ADSON (CONE)	126
Spreizer, HOLZHEIMER	120	TROUTMAN-CHRIS, Klingenbrecher	17	Wundspreizer, BECKMANN-EATON	132
Spreizer, INGE	152	Tumorfäßzange, LANDOLT	245	Wundspreizer, CASPAR	144, 154, 156
Spreizer, JANSEN	120	Tumorfäßzange, TOENNIS	91	Wundspreizer, CONE	126
Spreizer, KNIGHTON	134	Tumorgabel, OKONEK-YASARGIL	254	Wundspreizer, DARLING	147
Spreizer, Laminektomie	131	Tumorgabel, YASARGIL	257	Wundspreizer, GELPI	150

Wundspreizer, HARVEY-JACKSON	133	Zange, RUSKIN	168
Wundspreizer, HENLEY	123	Zange, RUSKIN-LISTON	172
Wundspreizer, JANSEN	120	Zange, SAUERBRUCH	170
Wundspreizer, KNIGHTON	134	Zange, SCHLESINGER	239
Wundspreizer, MARKHAM-MEYERDING	148	Zange, SEMB	171, 173
Wundspreizer, MAYO-ADAMS	124	Zange, SMITH-PETERSON	166
Wundspreizer, MEYERDING	148	Zange, SMITHWICK	174
Wundspreizer, MISKIMOM	128	Zange, SPURLING	238
Wundspreizer, MOLLISON	122	Zange, STAMM	172
Wundspreizer, NORFOLK/NORWICH	124	Zange, STELLBRINK	162
Wundspreizer, PLESTER	122, 124	Zange, STILLE-HORSLEY	173
Wundspreizer, TRAEVERS	125	Zange, STILLE-LISTON	173
Wundspreizer, WALTON	135	Zange, STILLE-LUER	169
Wundspreizer, WEITLANER	121	Zange, STILLE-RUSKIN	169
Wundspreizer, WEITLANER-WULLSTEIN	121	Zange, SWEET	174
Wundspreizer, WILLIAMS	149	Zange, TOENNIS	91
Wundspreizer, WULLSTEIN	122	Zange, WAGNER	241
Y		Zange, WEIL-BLAKESLEY	244
YASARGIL, Aneurysmen-Gefäßclip	294 - 301	Zange, WILLET-MARTEL	87
YASARGIL, Fadenführer	116	Zange, YASARGIL	245
YASARGIL, flexibler Spanarm	278	Zange, YASARGIL-NICOLA	271
YASARGIL, Galeahaken	114	Zange, ZAUFAL-JANSEN	167
YASARGIL, Hirnspatelhalter	276	ZAUFAL-JANSEN, Hohlmelßelzange	167
YASARGIL, Hypophyse-Zange	245	ZIELKE, Hohlmelßel	202
YASARGIL, Mikro-Federschere	41, 42, 45	ZÖLLNER, Saugrohr	232
YASARGIL, Mikro-Gefäßmesser	248		
YASARGIL, Mikro-Löffel	193		
YASARGIL, Mikro-Nadelhalter	98		
YASARGIL, Mikro-Pinzette	75		
YASARGIL, Mikro-Raspator	225 - 227		
YASARGIL, Ohrspekulumhalter	278		
YASARGIL, Präparierschere	42		
YASARGIL, Saugrohr	232		
YASARGIL, Tumorgabel	257		
YASARGIL, Tumorzinnette	70, 72, 75		
YASARGIL-NICOLA, Fußzange	271		
YASARGIL-SAMII, Tumorzinnette	72		
Z			
Zange f. Gefäßclips	302 - 305		
Zange f. offene Chirurgie	319, 320		
Zange, ADSON	163, 181		
Zange, BACON	166		
Zange, BANE-HARTMANN	164		
Zange, BEYER	165, 167		
Zange, BÖHLER	167, 172		
Zange, Bohrloch	180		
Zange, Bulldogklemme	83		
Zange, CAROLL	92		
Zange, CASPAR	242, 243		
Zange, CLOWARD	239		
Zange, COTTLE-KAZANJIAN	172		
Zange, CUSHING	238		
Zange, De VILBISS	178		
Zange, ECHLIN	171		
Zange, FERRIS-SMITH	241		
Zange, FRIEDMAN	162		
Zange, FRYKHOLM	171		
Zange, HOEN	240		
Zange, JANSEN	164		
Zange, KLEINERT-KUTZ	165		
Zange, LANDOLT	245, 263		
Zange, LEKSELL (STILLE)	170		
Zange, LEMPERS	164, 165		
Zange, LISTON	172		
Zange, Löffel, Hypophyse	272		
Zange, LOVE-GRUENWALD	238		
Zange, LUER	163		
Zange, MARQUARD	168		
Zange, MARTEL	87		
Zange, MAYFIELD	167		
Zange, Mc INDOE	172		
Zange, Mc KENZIE	174		
Zange, Mikro, Hypophyse	272		
Zange, NICOLA	271		
Zange, OLDBERG	245		
Zange, OLIVECRONA	164		
Zange, OLIVECRONA-TOENNIS	174		
Zange, RANEY	176		

A			
AACHEN brain spatula	274		
ACLAND applying forceps.....	318		
ACLAND clips.....	315-317		
ADLERKREUTZ forceps	54		
ADSON drill guide and forceps.....	181		
ADSON forceps	51, 52		
ADSON hypophyseal forceps.....	261		
ADSON nerve hook.....	110		
ADSON raspatory	218		
ADSON retractor.....	125, 126, 129		
ADSON rongeur	163		
ADSON suction tube	230		
ADSON micro forceps	51		
ADSON-BABY forceps	88		
ADSON-BROWN forceps	52		
ADSON-DE BAKEY forceps	51		
ALEXANDER elevator	210		
ALM retractor.....	120		
ANDERSON-ADSON retractor.....	128		
applying forceps ACLAND.....	318		
applying forceps BIEMER.....	306, 308, 309, 311		
applying forceps MEHDORN	307		
applying forceps for bulldog clamps	83		
applying forceps for clips	174		
applying forceps for scalp clips	176		
applying forceps for YASARGIL	302-305		
approximators BIEMER-MÜLLER	308		
approximators MÜLLER	309, 310		
atrauma forceps	67-69		
atrauma forceps DE BAKEY	67-69		
B			
BABINSKY percussion hammer	8		
BACON rongeur.....	166		
BADGLEY retractor.....	139		
BANE-HARTMANN rongeur	164		
BARON suction tube	231		
BARRAQUER needle holder	96		
BAUMGARTNER needle holder	94		
BECKMANN retractor.....	132		
BECKMANN-ADSON retractor.....	126, 130		
BECKMANN-EATON retractor	132		
BERLINER percussion hammer	8		
BEYER rongeur.....	165, 167		
BIEMER applying forceps.....	306, 308, 309, 311		
BIEMER scissors	44, 45		
BIEMER vessel clips	306, 312		
BIEMER vessel dilator	250		
BIEMER vessel spreader	250		
BIEMER-MÜLLER approximators	308		
bipolar cables	335		
bipolar forceps	328-334		
blade breaker CASTROVIEJO	17		
blade breaker REDA	17		
blade breaker TROUTMAN-CHRIS	17		
blade breaker	17		
blades scalpel	14-16		
BÖHLER bone cutting forceps	172		
BÖHLER rongeur	167		
BOIES elevator	211		
bone cutting forceps BÖHLER.....	172		
bone cutting forceps COTTLE-KAZANJIAN	172		
bone cutting forceps LISTON	172		
bone cutting forceps MCINDOE.....	172		
bone cutting forceps RUSKIN-LISTON	172		
bone cutting forceps SEMB.....	173		
bone cutting forceps STAMM.....	172		
bone cutting forceps STILLE-HORSLEY	173		
bone cutting forceps STILLE-LISTON	173		
bone cutting forceps	172-173		
bone graft holder and impactor CASPAR	194		
bore hold protection forceps	180		
brain spatula forceps	59		
brain spatula AACHEN	274		
brain spatula CUSHING.....	274		
brain spatula DAVIS	275		
brain spatula HEIFETZ	275		
brain spatula OLIVECRONA	274		
BROPHY forceps.....	54		
BROWN forceps	53		
BRUNS curette	188		
BUCK percussion hammer	8		
bulldog clamps.....	78-83		
bulldog clamp DE BAKEY	80, 81, 82		
bulldog clamp DE BAKEY-DIETHRICH.....	78		
bulldog clamp DE BAKEY-HESS	82		
bulldog clamp DIEFFENBACH	83		
bulldog clamp DIETHRICH	78		
bulldog clamp GLOVER.....	80, 81		
bulldog clamp JOHNS-HOPKINS.....	83		
bulldog clamp applying forceps	83		
BUNELL drill	325		
BUSHE curette.....	191		
C			
caliper	11		
CAROLL forceps.....	92		
CASPAR bone graft holder and impactor.....	194		
CASPAR dissector	227, 228		
CASPAR distractor	158		
CASPAR exploration hook	112, 115		
CASPAR hemostat.....	195		
CASPAR laminectomy forceps	242, 243		
CASPAR pusher	253		
CASPAR retractor	136, 144		
CASPAR retractor lumbar	154-157		
CASPAR scalpel blade	16		
CASTROVIEJO blade breaker	17		
CASTROVIEJO needle holder.....	97		
CASTROVIEJO scissors	36		
cerebellar retractor	128		
cervical retractors	140-146		
cervical traction tongs	176		
cervical vertebral body distraction system	158-160		
chisel STILLE	196		
chisels	196, 202		
CITELLI punch.....	288		
clamps bulldog.....	78-83		
clip applicators for open surgery	319, 320		
clip rack for clips	174		
clips ACLAND.....	315-317		
clips RANEY.....	176		
clips aneurysm YASARGIL	290-301		
CLOWARD laminectomy forceps	239		
CLOWARD retractor (blade retr.).....	103		
CLOWARD retractor cervical	141, 142, 143		
CLOWARD retractor lamina.....	151, 153		
COBB curette	184		
COBB elevator	217		
COBB gouge	200		
COBB raspatory	217		
COLCLOUGH rongeur.....	286		
CONE cranial punch	179		
CONE curette.....	260		
CONE retractor.....	126		
COTTLE forceps	74		
COTTLE hammer	10		
COTTLE osteotome	204		
COTTLE-KAZANJIAN bone cutting forceps	172		
cranial punch CONE	179		
CRILE forceps.....	85		
CRILE nerve hook.....	109		
CRILE-RANKIN forceps	85		
CRILE-WOOD needle holder	94		
CRUTCHFIELD tong	176		
curette BRUNS	188		
curette BUSHE	191		
curette COBB	184		
curette CONE	260		
curette DAUBENSPECK.....	189		
curette FAHLBUSCH	270		
curette HALLE	186		
curette HARDY	268		
curette LANDOLT.....	267		
curette LANDOLT-REULEN	270		
curette LEMBERT	190		
curette NICOLA	265		
curette REDA	190, 191		
curette SCOVILLE.....	187		
curette SPINAL.....	186, 187		
curette SPRATT	184		
curette VOLKMANN.....	184		
curette double JANSEN	192		
curette double VOKMANN.....	192		
curettes	262		
curettes bone	184-192		
CUSHING brain spatula.....	274		
CUSHING drill	324		
CUSHING elevator.....	207, 208		
CUSHING forceps	53		
CUSHING laminectomy forceps	238		
CUSHING nerve hook.....	109		
CUSHING retractor.....	103		
CUSHING-LANDOLT speculum.....	263		
CUSHING-TAYLOR forceps	57		
D			
DANDY forceps.....	86		
DANDY nerve hook.....	108		
DANDY scissors	33		
DARLING retractor.....	147		
DAUBENSPECK curette	189		
DAVIS brain spatula	275		
DAVIS dissector	221, 222		
DE BAKEY atrauma forceps	67-69		
DE BAKEY bulldog clamp.....	80, 81, 82		
DE BAKEY needle holder.....	95		
DE BAKEY scissors	30, 32		
DE BAKEY-DIETHRICH bulldog clamp.....	78		
DE BAKEY-HESS bulldog clamp	82		
DEAVER scissors	21		
DEJERINE percussion hammer	8		
DEMARTEL saw conductor	177		
D'ERRICO nerve root retractor	113		
DEVILBISS skull punch.....	178		
DIEFFENBACH bulldog clamp	83		
DIETHRICH bulldog clamp	78		
DIETRICH scissors	29, 30		
dilators vessel	61		
dissecting forceps	88-90		
dissecting scissors.....	22-26		
dissector CASPAR	227, 228		
dissector DAVIS	221, 222		
dissector FRAZIER	223		
dissector GORNEY	211		
dissector HARDY-FAHLBUSCH	266		
dissector HOEN	223		
dissector HORSLEY	222		
dissector LANDOLT-REULEN	270		
dissector MILLIGAN	222		
dissector OLIVECRONA	221		
dissector PENFIELD	224		
dissector SACHS	221		
dissector TOENNIS.....	221		
dissector WOODSON	223		
dissector YASARGIL	227		
distractor CASPAR	158		
DOYEN raspatory	212, 213		
dressing forceps.....	50-58		
drill BUNELL	325		
drill CUSHING	324		
drill HUDSON	324		
drill KIRSCHNER.....	325		
drill MOORE	323		
drill RALK	326		
drill REDA	326		
drill STILLE	322		
drill STILLE-SHERMAN.....	323		
drill guide and forceps ADSON.....	181		
DUEHRSEN forceps	55		
dura scissors	34		
dura hooks	108-110		

E			
ECHLIN rongeur.....	171	forceps MIXTER-BABY.....	90
elevator ALEXANDER.....	210	forceps MOSQUITO.....	84
elevator BOIES.....	211	forceps POTTS-SMITH.....	50
elevator COBB.....	217	forceps scalp.....	87
elevator CUSHING.....	207, 208	forceps SEMKEN.....	56
elevator FOMON.....	211	forceps TAYLOR.....	58
elevator FREER.....	220	forceps Tendon grasping.....	92
elevator HOEN.....	209	forceps tissue.....	50-58
elevator JOSEPH.....	211, 219	forceps TOENNIS.....	91
elevator KÖNIG.....	210	forceps tumor.....	70-73
elevator LANGENBECK.....	209	forceps tumor grasping.....	91
elevator LITTLE-JOKER.....	207	forceps ultra-light.....	65
elevator McDONALD.....	219	forceps WANGENSTEEN.....	58
elevator MOLT.....	210	forceps WAUGH.....	53
elevator QUERVAIN.....	208	forceps WILLET MARTEL.....	87
elevator ROGER.....	220	forceps applying MCKENZIE.....	174
elevator SEBILLEAU.....	208	forceps applying OLIVECRONA-TOENNIS.....	174
elevator SEDILLOT.....	207, 208	forceps applying RANEY.....	176
elevator SEWALL.....	219	forceps applying SMITHWICK.....	174
elevator WAGNER.....	217	forceps applying SWEET.....	174
elevator WATSON-CHEYNE.....	219	forceps micro ring.....	66
elevator WILLIGER.....	210	forceps micro tying.....	62-64
enucleator HARDY.....	266	fork spatula HOSOBUCHI.....	267
enucleator LANDOLT.....	267	FRAZIER suction tube.....	231
exploration and coagulation hooks.....	115	FRAZIER dissector.....	223
exploration hook CASPAR.....	112, 115	FRAZIER skin hook.....	102
		FREER elevator.....	220
		FREER skin hook.....	102
		FRIEDMANN mini rongeur.....	162
		FRIEDMANN mini rongeur.....	162
		FRYKHOLM rongeur.....	171
		FUCHSIG forceps.....	88
F			
FAHLBUSCH curette.....	270	G	
FAHLBUSCH micro scissors.....	271	galea hook YASARGIL.....	114
FAHLBUSCH scoop.....	270	galea hooks.....	114
FARABEUF raspatory.....	206	GALT skull trephine.....	161
FARABEUF-COLLIN raspatory.....	206, 207	GELPI retractor.....	150
FAVALORO scissors.....	31	GEMINI forceps.....	89
FERGUSON suction tube.....	230, 231	GERALD forceps.....	56, 57
FERRIS-SMITH laminectomy forceps.....	241	GIGLI handle saw.....	177
FERRIS-SMITH-KERRISON rongeur.....	282-285	GIGLI-STRULLY handle saw.....	177
FISCH hook.....	249	GILLIES forceps.....	56
FOMON elevator.....	211	GILLIES skin hook.....	102
forceps ADLERKREUTZ.....	54	GLOVER bulldog clamp.....	80, 81
forceps ADSON.....	51, 52	GORNEY dissector.....	211
forceps ADSON micro.....	51	gouge COBB.....	200
forceps ADSON-BABY.....	88	gouge LEXER.....	201
forceps ADSON-BROWN.....	52	gouge LEXER-MINI.....	201
forceps ADSON-DE BAKEY.....	51	gouge SMITH-PETERSEN.....	197
forceps atrauma.....	67-69	gouge STILLE.....	196
forceps BROPHY.....	54	gouge ZIELKE.....	202
forceps BROWN.....	53	GRADLE scissors.....	28
forceps CAROLL.....	92	GRAHAM nerve hook.....	110
forceps COTTLE.....	74	grasping forceps YASARGIL-NICOLA.....	271
forceps CRILE.....	85	guiding instruments.....	177
forceps CRILE-RANKIN.....	85	GUILLEN suction raspatory.....	235
forceps CUSHING.....	53		
forceps CUSHING-TAYLOR.....	57	H	
forceps DANDY.....	86	HAJEK-KOFLER punch.....	287, 288
forceps dissecting.....	88-90	HALLE curette.....	186
forceps dressing.....	50-58	HALSEY needle holder.....	94
forceps DUEHRSEN.....	55	HALSTED-MOSQUITO forceps.....	84
forceps FUCHSIG.....	88	hammer COTTLE.....	10
forceps GEMINI.....	89	hammer OMBREDANNE.....	10
forceps GERALD.....	56, 57	hammer plastic.....	9
forceps GILLIES.....	56	hammer WAGNER.....	10
forceps HALSTED-MOSQUITO.....	84	hammer WILLIGER.....	9
forceps HARTMANN.....	83	hammer.....	8-10
forceps hemostatic.....	83-86	handle saw GIGLI.....	177
forceps JACOBSON.....	84	handle saw GIGLI-STRULLY.....	177
forceps JANSEN.....	74	handle saw REDA.....	177
forceps JANSEN-GRÜNWARDL.....	74	HARDY curette.....	268
forceps jeweler.....	60	HARDY enucleator.....	266
forceps KELLY.....	85	HARDY implant fork.....	266
forceps KELLY-RANKIN.....	85	HARDY micro mirror.....	269
forceps ligature.....	88-90	HARDY spoon.....	269
forceps light ultra.....	65	HARDY-FAHLBUSCH dissector.....	266
forceps LUCAE.....	74	HARTMANN forceps.....	83
forceps MARTEL.....	87	HARVEY-JACKSON retractor.....	133
forceps MIAYO.....	58		
forceps MCINDOE.....	55	HEIFETZ brain spatula.....	275
forceps micro ring.....	66	HEIFETZ tumor forceps.....	72
forceps MICRO-HARTMANN.....	83	hemilaminectomy retractor.....	147-149
		hemostat CASPAR.....	195
		hemostatic forceps.....	83-86
		HENLEY retractor.....	123
		HESS nerve root retractor.....	111
		HOEN dissector.....	223
		HOEN elevator.....	209
		HOEN laminectomy forceps.....	240
		HOLSHER nerve root retractor.....	111
		HOLZHEIMER retractor.....	120
		hook FISCH.....	249
		hook LANDOLT.....	267
		hook LANDOLT-REULEN.....	270
		hooks.....	102-118
		HORSLEY dissector.....	222
		HOSOBUCHI fork spatula.....	267
		HOUSE suction adapter.....	231
		HOUSE suction tube.....	233
		HUDSON drill.....	324
		HUNT tumor forceps.....	71
		hypophyseal forceps ADSON.....	261
		hypophyseal forceps LANDOLT.....	264
		I	
		implant fork HARDY.....	266
		INGE retractor.....	152
		iris scissors.....	27
		J	
		JACOBSON forceps.....	84
		JACOBSON probe.....	249
		JACOBSON pusher.....	253
		JACOBSON scissors.....	44, 45
		JAMESON-WERBER scissors.....	26
		JANSEN curette double.....	192
		JANSEN raspatory.....	206
		JANSEN retractor.....	120
		JANSEN rongeur.....	164
		JANSEN forceps.....	74
		JANSEN-GRÜNWARDL forceps.....	74
		jeweler forceps.....	60
		JOHNS-HOPKINS bulldog clamp.....	83
		JOSEPH elevator.....	211, 219
		JOSEPH skin hook.....	102
		K	
		KELLY forceps.....	85
		KELLY scissors.....	21
		KELLY-RANKIN forceps.....	85
		KERRISON punch.....	287
		KEY raspatory.....	218
		key for approximator.....	312
		KILNER scissors.....	26
		KIRSCHNER drill.....	325
		KLEINERT-KUTZ rongeur.....	165
		knife KOOS.....	248, 249
		knife SAMILI.....	251, 252
		knife YASARGIL.....	248
		KNIGHTON retractor.....	134
		KOCHER retractor.....	105
		KOCHER-LANGENBECK retractor.....	104
		KÖNIG elevator.....	210
		KOOS knife.....	248, 249
		KOOS probe.....	249
		KRAYENBUHL nerve and vessel hook.....	116

L			
LADOLT pituitary forceps.....	245	micro pituitary forceps	272
LAMBOTTE osteotome.....	198	micro ring forceps.....	66
LAMBOTTE raspatory.....	207	micro scissors FAHLBUSCH	271
LAMBOTTE-MINI osteotome.....	199	micro scissors	272
lamina gouge	203	micro scoops	193
lamina spreaders	151-153	MICRO-FRIEDMANN rongeur	162
laminectomy forceps CASPAR	242, 243	MICRO-HARTMANN forceps.....	83
laminectomy forceps CLOWARD	239	MILLESII scissors.....	44, 45
laminectomy forceps CUSHING.....	238	MILLIGAN dissector	222
laminectomy forceps FERRIS-SMITH	241	MILLS scissors	29
laminectomy forceps HOEN	240	MISKIMON retractor.....	128
laminectomy forceps LOVE-GRUENWALD	238	MIXTER-BABY forceps.....	90
laminectomy forceps SCHLESINGER	239	MOLLISON retractor	122
laminectomy forceps SPURLING	238	MOLT elevator.....	210
laminectomy forceps WAGNER	241	MOORE drill	323
laminectomy retractors	129-139	MOSQUITO forceps.....	84
LANDOLT curette	267	MÜLLER approximators	309, 310
LANDOLT nucleator	267	N	
LANDOLT hook.....	267	NAGEL scissors.....	43
LANDOLT hypophyseal forceps.....	264	nasal forceps WEIL-BLAKESLEY	244
LANDOLT scalpel blade	16	needle holder BARRAQUER.....	96
LANDOLT scoop.....	267	needle holder BAUMGARTNER.....	94
LANDOLT spreader.....	263	needle holder CASTROVIEJO.....	97
LANDOLT-REULEN curette.....	270	needle holder CRILE-WOOD.....	94
LANDOLT-REULEN dissector	270	needle holder DE BAKEY.....	95
LANDOLT-REULEN hook.....	270	needle holder HALSEY	94
LANDOLT-REULEN raspatory.....	270	needle holder MAYO-HEGAR	95
LANGENBECK elevator	209	needle holder NEIVERT	94
LANGENBECK retractor	104, 105	needle holder RYDER	95
LAZAR tying forceps.....	63	needle holder YASARGIL.....	98
LEKSELL rongeur	170	needle holders	94-100
LEMBERT curette	190	NEIVERT needle holder	94
LEMPERT rongeur.....	164, 165	nerve and vessel hook KRAYENBÜHL	116
LEXER gouge.....	201	nerve dissecting scissors	27
LEXER osteotome.....	201	nerve hook ADSON	110
LEXER scissors.....	22	nerve hook CRILE	109
LEXER-MINI gouge.....	201	nerve hook CUSHING.....	109
LEXER-MINI osteotome.....	201	nerve hook DANDY	108
LEYLA retractor.....	276-280	nerve hook GRAHAM	110
ligature forceps.....	88-90	nerve hook SACHS.....	110
ligature guides YASARGIL	116	nerve hook SMITHWICK.....	110
ligature guides	116	nerve hooks	116
light ultra forceps	65	nerve hooks	108-110
LISTON bone cutting forceps.....	172	nerve root retractor D'ERRICO	113
LITTLE-JOKER elevator	207	nerve root retractor HESS.....	111
LOVE nerve root retractor	113, 114	nerve root retractor HOLSHER.....	111
LOVE-GRUENWALD laminectomy forceps	238	nerve root retractor LOVE	113, 114
LUCAE forceps	74	nerve root retractor SCOVILLE.....	111, 114
LUER rongeur	163	nerve root retractors	111-114
lumbar retractor	154-157	NICOLA curette.....	265
M		NICOLA micro forceps.....	271
MARKHAM-MEYERDING retractor	148	NICOLA raspatory	265
MARQUARDT rongeur.....	168	NORFOLK/NORWICH retractor.....	124
MARTEL forceps.....	87	O	
MATSON raspatory	213	OKONEK-YASARGIL tumor fork.....	254
MATSON-ALEXANDER raspatory.....	213	OLDBERG pituitary forceps.....	245
MAYFIELD rongeur	167	OLIVECROWNA brain spatula	274
MAYO forceps.....	58	OLIVECROWNA dissector	221
MAYO scissors	22	OLIVECROWNA rongeur.....	164
MAYO-ADAMS retractor	124	OLIVECROWNA scissors.....	33
MAYO-HEGAR needle holder	95	OLIVECROWNA wire saw	177
MAYO-STILLE scissors.....	22	OLIVECROWNA-TOENNIS forceps applying	174
MCDONALD elevator	219	OMBREDANNE hammer	10
MCINDOE bone cutting forceps.....	172	operating scissors	20-21
MCINDOE forceps	55	osteotome COTTLE.....	204
MCKENZIE forceps applying.....	174	osteotome LAMBOTTE.....	198
MEHDORN applying forceps.....	307	osteotome LAMBOTTE-MINI.....	199
MEHDORN vessel clips	307	osteotome LEXER.....	201
METZENBAUM scissors	23-25	osteotome LEXER-MINI.....	201
MEYERDING retractor	106, 148	osteotome SMITH-PETERSEN.....	197
MICHELE trephine	182	osteotome STILLE	196
micro scissors	35-46	P	
micro cup-shaped forceps	272	PAPAVERO-CASPAR speculum.....	264
micro forceps NICOLA.....	271	PAPAVERO-HARTMANN spreader	264
micro instruments YASARGIL	75	PENFIELD dissector	224
micro instruments RHOTON	256	percussion hammer BABINSKY	8
micro mirror HARDY	269	percussion hammer BERLINER.....	8
micro needle holders	96-100	percussion hammer BUCK.....	8
		percussion hammer DEJERINE.....	8
		percussion hammer TAYLOR.....	8
		percussion hammer TROEMNER	8
		pin wheel WARTENBERG.....	11
		pituitary forceps LADOLT.....	245
		pituitary forceps OLDBERG.....	245
		pituitary forceps YASARGIL	245
		plastic hammer	9
		PLESTER retractor.....	122, 124
		PLESTER suction tube	233
		POTTS DE-MARTEL scissors.....	29
		POTTS-SMITH forceps.....	50
		POTTS-SMITH scissors.....	30, 31
		POTTS-YASARGIL scissors.....	44, 45
		probe JACOBSON	249
		probe KOOS	249
		punch CITELLI	288
		punch HAJEK-KÖFLER	287, 288
		punch KERRISON	287
		pusher CASPAR.....	253
		pusher JACOBSON	253
		Q	
		QUERVAIN elevator	208
		R	
		RALK drill.....	326
		RANEY clips.....	176
		RANEY forceps applying	176
		raspatory ADSON	218
		raspatory COBB	217
		raspatory DOYEN	212, 213
		raspatory FARABEUF	206
		raspatory FARABEUF-COLLIN	206, 207
		raspatory JANSEN.....	206
		raspatory KEY	218
		raspatory LAMBOTTE.....	207
		raspatory LANDOLT-REULEN.....	270
		raspatory MATSON.....	213
		raspatory MATSON-ALEXANDER	213
		raspatory NICOLA.....	265
		raspatory SELDIN.....	211
		raspatory YASARGIL	225, 226
		REDA blade breaker	17
		REDA curette	190, 191
		REDA drill.....	326
		REDA handle saw	177
		retractor ADSON.....	125, 126, 129
		retractor ALM	120
		retractor ANDERSON-ADSON.....	128
		retractor BADGLEY.....	139
		retractor BECKMANN	132
		retractor BECKMANN-ADSON	126, 130
		retractor BECKMANN-EATON	132
		retractor CASPAR	136, 144
		retractor CONE	126
		retractor CUSHING	103
		retractor DARLING.....	147
		retractor GELPI.....	150
		retractor HARVEY-JACKSON	133
		retractor HENLEY.....	123
		retractor HOLZHEIMER	120
		retractor INGE	152
		retractor JANSEN	120
		retractor KNIGHTON	134
		retractor KOCHER	105
		retractor KOCHER-LANGENBECK	104
		retractor LANGENBECK	104, 105
		retractor LEYLA	276-280
		retractor lumbar.....	154-157
		retractor MARKHAM-MEYERDING	148
		retractor MAYO-ADAMS	124
		retractor MEYERDING	106, 148
		retractor MISKIMON	128
		retractor MOLLISON	122
		retractor NORFOLK/NORWICH	124
		retractor PLESTER.....	122, 124
		retractor SCALP-CONTOUR	127
		retractor SCOVILLE	137

W

WAGNER elevator.....	217
WAGNER hammer	10
WAGNER laminectomy forceps.....	241
WALTON retractor.....	135
WANGENSTEEN forceps.....	58
WARTENBERG pin wheel.....	11
WATSON-CHEYNE elevator	219
WAUGH forceps	53
WEIL-BLAKESLEY nasal forceps	244
WEITLANER retractor	121
WEITLANER-WULLSTEIN retractor.....	121
WILLET MARTEL forceps	87
WILLIAMS retractor	149
WILLIGER elevator.....	210
WILLIGER hammer.....	9
wire saws	177
wire saws OLIVECRONA	177
WOODSON dissector.....	223
WULLSTEIN retractor	122
WULLSTEIN suction tube.....	234

Y

YASARGIL clips aneurysm.....	290-301
YASARGIL dissector	227
YASARGIL galea hook	114
YASARGIL knife	248
YASARGIL ligature guides	116
YASARGIL micro forceps.....	75
YASARGIL needle holder.....	98
YASARGIL pituitary forceps.....	245
YASARGIL raspatory.....	225, 226
YASARGIL scissors.....	41, 42, 44, 45
YASARGIL suction tube.....	232
YASARGIL tumor forceps	72
YASARGIL tumor fork	257
YASARGIL-NICOLA grasping forceps	271
YASARGIL-SAMII tumor forceps	72

Z

ZAUFAL-JANSEN rongeur.....	167
ZIELKE gouge.....	202
ZÖLLNER suction tube.....	232

A			
AACHEN espátula cerebral	274		
ACLAND aproximador	315-317		
ACLAND micro clip vascular	315-317		
ACLAND pinza aplicadora	318		
ADAMS-MAYO separador	124		
adaptador HOUSE	231		
adaptador para aspiración	231		
ADLERKREUTZ pinza de disección	54		
ADSON ANDERSON separador para cerebelo	128		
ADSON elevador	218		
ADSON gancho	110		
ADSON pinza de disección	51-52		
ADSON pinza gubia	163		
ADSON pinza guía taladros y protectora de duramadre	181		
ADSON pinza para hipofisis	261		
ADSON separador	125-126		
ADSON separador para laminectomía	129		
ADSON tubo de aspiración	230		
ADSON-BABY pinza	88		
ADSON-BECKMANN (CONE) separador	126		
ADSON-BECKMANN separador para laminectomía	130		
ADSON-BROWN pinza de disección	52		
ADSON-DE BAKEY pinza de disección	51		
ADSON-TOENNIS tijera de disección	27		
aguja RHOTON	256		
alargadera pieza	324		
ALEXANDER periotomoto	210		
ALEXANDER-MATSON periotomoto	214		
ALM separador	120		
ANDERSON ADSON separador para cerebelo	128		
aplicadora pinza	83, 174, 176, 302-305, 318-320		
aproximador	308-309, 311, 315-317		
aproximador ACLAND	315-317		
aproximador BIEMER	311-312		
aproximador BIEMER-MÜLLER	308		
aproximador MÜLLER	309		
Atomizador	160		
AUSTIN micro pinza	64		
B			
BABINSKY martillo de percusión	8		
BABY MIXTER pinza hemostática	90		
BABY-ADSON pinza	88		
BABY-METZENBAUM BLACK tijera de disección	25		
BACON pinza gubia	166		
BADGLEY separador para laminectomía	139		
BANE-HARTMANN pinza gubia	164		
BARON tubo de aspiración	231		
BARRAQUER micro porta aguja	96		
BAUMGARTNER porta aguja	94		
BECKMANN separador para laminectomía	132		
BECKMANN-ADSON (CONE) separador	126		
BECKMANN-ADSON separador para laminectomía	130		
BECKMANN-EATON separador para laminectomía	132		
BERLINER martillo de percusión	8		
BEYER pinza gubia	165, 167		
BIEMER aproximador	311-312		
BIEMER clip para vasos	306		
BIEMER micro tijera	44-45		
BIEMER pinza aplicadora	306, 308-309, 311		
BIEMER separador para vasos	250		
BIEMER-MÜLLER aproximador	308		
bipolar cable	335		
bipolar coagulación	328-333		
bipolar pinza	328-334		
bipolar pinza de succión	334		
bipolar pinza non-stick	332-333		
bisturí	15		
BLACK METZENBAUM tijera de disección	24-25		
BLACK tijera de disección	25		
BLAKESLEY-WEIL pinza para laminectomía	244		
BÖHLER pinza cortante para huesos	172		
BÖHLER pinza gubia	167		
BOIES elevador	211		
broca	160, 176, 322-324		
broca CUSHING	324		
broca ERRICO	324		
broca MC KENZIE	324		
BROPHY pinza de disección	54		
BROWN pinza de disección	53		
BROWN-ADSON pinza de disección	52		
BRUNS cucharilla cortante	188		
BUCK martillo de percusión	8		
bulldog clamp	78-82		
bulldog clamp DE BAKEY	80-82		
bulldog clamp DE BAKEY-HESS	82		
bulldog clamp DIETRICH	78		
bulldog clamp GLOVER	80-81		
BUNELL perforador de mano	325		
BUSHE cucharilla cortante	191		
C			
cable bipolar	335		
CAJA	338-343		
calibrador	11		
canula para mango de aspiración	232, 234		
CAROLL pinza para tendones	92		
CASPAR empujador de sutura	253		
CASPAR gancho para exploración y coagulación	115		
CASPAR hemostático	195		
CASPAR injerto oseo titular y impactador	194		
CASPAR mango de bisturí	16		
CASPAR micro disector	227-228		
CASPAR pinza para laminectomía	242-243		
CASPAR separador cervical	144		
CASPAR separador lumbar	154-156		
CASPAR separador para laminectomía	136		
CASPAR separador para nervios	112		
CASPAR sistema de distracción vertebral	158		
CASPAR-PAPAVERO espejuelo para hipofisectomía	264		
CASTROVIEJO micro porta aguja	97		
CASTROVIEJO micro tijera	36		
CASTROVIEJO rompe-hojas	17		
CHEYNE-WATSON elevador	219		
CHRIS-TROUTMAN rompe-hojas	17		
cincel	196, 202		
cincel STILLE	196		
CITELLI pinza	288		
clamp bulldog	78-82		
clamp bulldog DE BAKEY	80-82		
clamp bulldog DE BAKEY-DIETRICH	78		
clamp bulldog DE BAKEY-HESS	82		
clamp bulldog DIETRICH	78		
clamp bulldog GLOVER	80-81		
Clip	176		
clip micro vascular	312		
clip para aneurisma	290-301		
clip para aneurisma YASARGIL	290-301		
clip para vasos	306-307, 310		
clip para vasos BIEMER	306		
clip para vasos MEHDORN	307		
clip para vasos MÜLLER	310		
clip vascular ACLAND	315-317		
clip vascular micro	312		
CLOWARD pinza para laminectomía	239		
CLOWARD separador cervical	140-143		
CLOWARD separador de hoja	103		
CLOWARD separador para vertebrales	151, 153		
coagulación bipolar	328-333		
COBB cucharilla cortante	185		
COBB gubia	200		
COBB periotomoto	217		
COLCLOUGH pinza para sacabocado para discos intervertebrales	286		
COLLIN-FARABEUF periotomoto	206-207		
CONE cureta	260		
CONE pinza sacabocado craneal	179		
contenedor para esterilización y almacenaje	313-314		
CONTOUR-SCALP separador para el cuero cabelludo	127		
costotomo GIERTZ-STILLE	48		
costotomo SAUERBRUCH	48		
costotomo SAUERBRUCH-FREY	48		
COTTLE martillo	10		
COTTLE ostotomoto	204		
COTTLE pinza	74		
COTTLE-KAZANJIAN pinza cortante para huesos	172		
CRILE gancho	109		
CRILE pinza hemostática	85		
CRILE-RANKIN pinza hemostática	85		
CRILE-WOOD porta aguja	94		
CRUTCHFIELD pinza de tracción craneal	176		
cuchara	184-192, 256, 267, 269, 270		
cucharilla	184-192, 256, 267, 269, 270		
cucharilla cortante BRUNS	188		
cucharilla cortante BUSHE	191		
cucharilla cortante COBB	185		
cucharilla cortante DAUBENSPECK	189		
cucharilla cortante HALLE	186		
cucharilla cortante JANSEN	192		
cucharilla cortante LEMPERT	190		
cucharilla cortante REDA	190-191		
cucharilla cortante SCOVILLE	187		
cucharilla cortante SPINAL	186-187		
cucharilla cortante SPRATT	184		
cucharilla cortante VOLKMANN	184, 192		
cucharilla FAHLBUSCH	270		
cucharilla HARDY	269		
cucharilla LANDOLT	267		
cucharilla micro	193, 256		
cucharilla micro YASARGIL	193		
cucharilla RHOTON	256		
cucharilla RHOTON	256		
cucharillas cortantes	184-192, 256, 267, 269, 270		
cuchillo JACOBSON	117, 118		
cuchillo micro KOOS	248-249		
cuchillo micro YASARGIL	248		
cuchillo para tumores SAMII	251-252		
cureta	260, 262, 265, 268, 270		
cureta CONE	260		
cureta FAHLBUSCH	270		
cureta HARDY	268		
cureta LANDOLT	267		
cureta LANDOLT-REULEN	270		
cureta NICOLA	265		
CUSHING (LITTLE-JOKER) periotomoto	207		
CUSHING broca	324		
CUSHING espátula cerebral	274		
CUSHING fresa	324		
CUSHING gancho	109		
CUSHING periotomoto	207, 208		
CUSHING pinza de disección	53		
CUSHING pinza para laminectomía	238		
CUSHING separador	103		
CUSHING taladro	324		
CUSHING-LANDOLT espejuelo para hipofisectomía	263		
CUSHING-TAYLOR pinza de disección	57		
D			
DANDY gancho	108		
DANDY pinza hemostática	86		
DANDY tijera para trigémino	33		
DARLING separador para hemilaminectomía	147		
DAUBENSPECK cucharilla cortante	189		
DAVIS disector	221-222		
DAVIS espátula cerebral	275		
DE BAKEY clamp bulldog	80-82		
DE BAKEY micro pinza	67		
DE BAKEY pinza	68-69		
DE BAKEY porta aguja	95		
DE BAKEY tijera vascular	30-32		
DE BAKEY-ADSON pinza de disección	51		
DE BAKEY-DIETRICH clamp bulldog	78		
DE BAKEY-HESS clamp bulldog	82		
DE MARTEL-POTTS tijera vascular	29		
DEAVER tijera para cirugía	21		
DEJERINE martillo de percusión	8		
DeMARTEL guía-conductora	177		
D'ERRICO separador para nervios	113		
DEVILBISS pinza sacabocado craneal	178		
diapason	11		
DIFFENBACH serra-fina	83		
DIETRICH clamp bulldog	78		
DIETRICH tijera vascular	29-30		
DIETRICH-DE BAKEY clamp bulldog	78		
dilatador vascular	61, 250		
disector	206-224, 256, 266, 270		
disector SACHS	221		
disector TOENNIS	221		
disector DAVIS	221-222		

disector FRAZIER	223	FRIEDMANN MICRO pinza gubia.....	162	HOEN disector.....	223
disector GORNEY	211	FRIEDMANN MINI pinza gubia.....	162	HOEN periostotomo.....	209
disector HOEN	223	FRIEDMANN pinza gubia.....	162	HOEN pinza para laminectomia.....	240
disector HORSLEY	222	FRYKHOLM pinza gubia.....	171	hoja SCOVILLE	137
disector LANDOLT-REULEN	270	FUCHSIG pinza.....	88	hoja TAYLOR.....	137
disector micro CASPAR	227-228			hojas.....	136-138, 140-146, 156-157
disector micro YASARGIL	227	G		HOLSHER separador para nervios.....	111
disector MILLIGAN	222	GALT trepano craneal	181	HOLZHEIMER separador.....	120
disector OLIVECRONA	221	gancho	102, 108-110, 114-118, 249, 256, 267, 270	HOPKINS-JOHNS serra-fina.....	83
disector PENFIELD	224	gancho ADSON	110	horquilla de implante HARDY	266
disector RHOTON	256	gancho CRILE	109	horquilla para tumores	254, 257
disector WOODSON	223	gancho CUSHING.....	109	horquilla para tumores OKONEY-YASARGIL	254
DONALD MC elevador.....	219	gancho DANDY	108	horquilla para tumores YASARGIL	257
DOYEN periostotomo	212-213	gancho FISCH	118, 249	HORSLEY disector	222
DUEHRSEN pinza de diseccion	55	gancho FRAZIER	102	HORSLEY-STILLE pinza cortante para huesos	173
		gancho FREER.....	102	HOSOBUCHI espátula.....	267
		gancho GILLIES	102	HOUSE adaptador.....	231
E		gancho GRAHAM	110	HOUSE tubo de aspiracion	233
EATON-BECKMANN separador para laminectomia.....	132	gancho JOSEPH.....	102	HUDSON perforador de mano	324
ECHLIN pinza gubia	171	gancho LANDOLT.....	267	HUNT pinza para tumores y tejido	70-71
elevador.....	206-220	gancho LANDOLT-REULEN	270		
elevador ADSON.....	218	gancho para coagulacion y exploracion CASPAR.....	115	I	
elevador BOIES	211	gancho para duramadre FISCH.....	118, 249	impactador y injerto oseos titular CASPAR.....	194
elevador FREER.....	220	gancho para exploracion y coagulacion CASPAR.....	115	INDOE MC pinza cortante para huesos	172
elevador JOSEPH	219	gancho para galea YASARGIL.....	114	INDOE MC pinza de diseccion	55
elevador KEY	218	gancho para nervios y vasos KRAYENBÜHL	116	INGE separador para vertebrales	152
elevador MC DONALD	219	gancho para vasos y nervios KRAYENBÜHL	116	injerto oseos titular y impactador CASPAR.....	194
elevador QUERVAIN	208	gancho RHOTON.....	256	IRIS tijera	27
elevador ROGER	220	gancho SACHS	110		
elevador SEBILEAU	208	gancho SCOVILLE	137	J	
elevador SEWALL	219	gancho SMITHWICK.....	110	JACKSON-HARVEY separador para laminectomia.....	133
elevador WATSON-CHEYNE	219	garra para tejido.....	255	JACOBSON cuchillo	117, 118
empujador de sutura CASPAR	253	GELPI separador	150	JACOBSON empujador de sutura	253
empujador de sutura JACOBSON	253	GEMINI pinza	89	JACOBSON micro tijera	44-45
enucleador	266-267	GERALD pinza de diseccion	56-57	JACOBSON pinza hemostatica	84
enucleador HARDY	266	GIERTZ-STILLE costotomo	48	JACOBSON sonda	249
enucleador LANDOLT	267	GIGLI mango para sierra	177	JAMESON WERBER tijera de diseccion	26
EQUIPO	338-343	GIGLI STRULLY mango para sierra	177	JANSEN cuchara cortante	192
ERRICO broca	324	GILLIES gancho	102	JANSEN periostotomo.....	206
ERRICO fresa	324	GILLIES pinza de diseccion	56	JANSEN pinza	74
ERRICO taladro	324	GLOVER clamp bulldog	80-81	JANSEN pinza gubia	164
espátula cerebral	274-275	GORNEY disector	211	JANSEN separador.....	120
espátula cerebral AACHEN.....	274	GRADLE tijera.....	28	JANSEN-GRUENWALD pinza	74
espátula cerebral CUSHING.....	274	GRAHAM gancho	110	JANSEN-ZAUFAL pinza gubia	167
espátula cerebral DAVIS	275	GRUENWALD-JANSEN pinza	74	JOHNS-HOPKINS serra-fina.....	83
espátula cerebral HEIFETZ	275	GRUENWALD-LOVE pinza para laminectomia	238	JOSEPH elevador	219
espátula cerebral OLIVECRONA	274	gubia	196-197, 200-203	JOSEPH gancho	102
espátula HOSOBUCHI.....	267	gubia COBB	200	JOSEPH periostotomo	211
espátula-pinza SCOVILLE	59	gubia LEXER	201		
especulo para hipofisectomia CUSHING-LANDOLT	263	gubia LEXER MINI	201	K	
especulo para hipofisectomia PAPAVERO-CASPAR	264	gubia SMITH-PETERSEN	197	KAZANJIAN-COTTLE pinza cortante para huesos.....	172
espejo micro HARDY	269	gubia STILLE	196	KELLY pinza hemostatica	85
		gubia ZIELKE	202	KELLY tijera para cirugia	21
		guia telescopica	325	KELLY-RANKIN pinza hemostatica.....	85
F		guia-conductora DeMARTEL	177	KENZIE MC broca	324
FAHLBUSCH cucharilla	270	guiador YASARGIL	116	KENZIE MC fresa	324
FAHLBUSCH cureta	270	GUILLEN legra de aspiracion	235	KENZIE MC pinza aplicadora	174
FAHLBUSCH micro tijera	271			KENZIE MC taladro.....	324
FARABEUF periostotomo	206	H		KERRISON pinza	287
FARABEUF-COLLIN periostotomo	206-207	H		KEY elevador	218
FAVALORO tijera vascular	32	HAJEK-KOFLER pinza	287-288	KILNER tijera de diseccion	26
FERGUSSON tubo de aspiracion	230	HALLE cucharilla cortante	186	KIRSCHNER perforador de mano	325
FERGUSSON/FRAZIER tubo de aspiracion	231	HALSEY porta aguja	84	KLEINERT-KUTZ pinza gubia	165
FERGUSSON/FRAZIER tubo de puncion	231	HALSTED-MOSQUITO pinza hemostatica	94	KNIGHTON separador para laminectomia	134
FERRIS-SMITH pinza para laminectomia	241	HARDY cucharilla	269	KOCHER separador.....	105
FERRIS-SMITH-KERRISON pinza sacabocado para		HARDY cureta.....	268	KOCHER-LANGENBECK separador	104
discos intervertebrales	282-285	HARDY enucleador	266	KOFLER-HAJEK pinza	287-288
FINO METZENBAUM tijera de diseccion	23	HARDY horquilla de implante	266	KÖNIG periostotomo	210
FISCH gancho	118, 249	HARDY micro espejo	269	KOOS micro cuchillo	248-249
FISCH gancho para duramadre.....	118, 249	HARTMANN pinza hemostatica	83	KRAYENBÜHL gancho para nervios y vasos	116
FOMON periostotomo	211	HARTMANN-BANE pinza gubia	164	KUTZ-KLEINERT pinza gubia.....	165
FRAZIER disector	223	HARTMANN-PAPAVERO pinza para especulo	264		
FRAZIER gancho	102	HARVEY-JACKSON separador para laminectomia.....	133		
FRAZIER/FERGUSSON tubo de aspiracion	231	HAVERFIELD-SCOVILLE separador para laminectomia	137		
FRAZIER/FERGUSSON tubo de puncion	231	HEGAR-MAYO porta aguja	95		
FREER elevador	220	HEIFETZ espátula cerebral	275		
FREER gancho.....	102	HEIFETZ pinza para tumores y tejido	72		
fresa	160, 176, 322-324	hemostatico	195		
fresa CUSHING.....	324	hemostatico CASPAR	195		
fresa ERRICO.....	324	HENLEY separador.....	123		
fresa MC KENZIE.....	324	HESS separador para nervios	111		
FREY-SAUERBRUCH costotomo.....	48				

separador para laminectomia BECKMANN	132	tijera de diseccion BABY-METZENBAUM BLACK	25	W	
separador para laminectomia BECKMANN-ADSON (CONE)	130	tijera de diseccion BLACK	25	WAGNER martillo	10
separador para laminectomia BECKMANN-EATON	132	tijera de diseccion JAMESON WEBBER	26	WAGNER periototomo	217
separador para laminectomia CASPAR	136	tijera de diseccion KILNER	26	WAGNER pinza para laminectomia	241
separador para laminectomia HARVEY-JACKSON	133	tijera de diseccion LEXER	22	WALTON separador para laminectomia	135
separador para laminectomia KNIGHTON	134	tijera de diseccion MAYO	22	WANGENSTEEN pinza de diseccion	58
separador para laminectomia SCOVILLE	137	tijera de diseccion MAYO-STILLE	22	WARTENBERG sensimetro	11
separador para laminectomia SCOVILLE-HAVERFIELD	137	tijera de diseccion METZENBAUM	23	WATSON-CHEYNE elevador	219
separador para laminectomia SCOVILLE-RICHTER	138	tijera de diseccion METZENBAUM BLACK	24-25	WAUGH pinza de diseccion	53
separador para laminectomia WALTON	135	tijera de diseccion METZENBAUM FINO	23	WEIL-BLAKESLEY pinza para laminectomia	244
separador para nervios CASPAR	112	tijera de diseccion para nervios	27	WEITLANER separador	121
separador para nervios D'ERRICO	113	tijera de diseccion REYNOLDS	26	WEITLANER-WULLSTEIN separador	121
separador para nervios HESS	111	tijera de diseccion TOENNIS-ADSON	27	WERBER JAMESON tijera de diseccion	26
separador para nervios HOLSHER	111	tijera GRADLE	28	WILLET MARTEL pinza pericraneal	87
separador para nervios LOVE	113-114	tijera IRIS	27	WILLIAMS separador para hemilaminectomia	149
separador para nervios SCOVILLE	111, 114	tijera micro BIEMER	44-45	WILLIGER martillo	9
separador para vasos BIEMER	250	tijera micro CASTROVIEJO	36	WILLIGER periototomo	210
separador para vertebrales CLOWARD	151, 153	tijera micro FAHLBUSCH	271	WOOD-CRILE porta aguja	94
separador para vertebrales INGE	152	tijera micro JACOBSON	44-45	WOODSON disector	223
separador PLESTER	122, 124	tijera micro MILLESÍ	44-45	WULLSTEIN separador	122
separador TRAVERS	125	tijera micro NAGEL	43	WULLSTEIN tubo de aspiracion	234
separador WEITLANER	121	tijera micro NICOLA	271	WULLSTEIN-WEITLANER separador	121
separador WEITLANER-WULLSTEIN	121	tijera micro VANNAS	37, 42, 44-45		
separador WULLSTEIN	122	tijera micro YASARGIL	41-42, 44-45	Y	
separadores	103-107, 111-114, 120-157	tijera para alambre UNIVERSAL	34	YASARGIL clips para aneurisma	290-301
separador LANGENBECK	104-105	tijera para cirugia DEEVER	21	YASARGIL gancho para galea	114
serra-fina DIEFFENBACH	83	tijera para cirugia KELLY	21	YASARGIL guidador	116
serra-fina JOHNS-HOPKINS	83	tijera para cirugia STANDARD	20	YASARGIL horquilla para tumores	257
SET	338-343	tijera para duramadre SCHMIEDEN-TAYLOR	34	YASARGIL legra	225-227
SEWALL elevador	219	tijera para neurocirugia STRULLY	33	YASARGIL micro cucharilla	193
SHERMAN-STILLE perforador a mano	323	tijera para trigemino DANDY	33	YASARGIL micro cuchillo	248
sierra OLIVECRONA	177	tijera para trigemino OLIVECRONA	33	YASARGIL micro disector	227
sistema de distraccion vertebral	158-160	tijera para tumores	47	YASARGIL micro pinza	75
sistema de distraccion vertebral CASPAR	158	tijera STEVENS	28	YASARGIL micro porta aguja	98
SMITH-FERRIS pinza para laminectomia	241	tijera vascular DE BAKEY	30-32	YASARGIL micro tijera	41-42, 44-45
SMITH-PETERSEN gubia	197	tijera vascular DIETRICH	29-30	YASARGIL periototomo	225-227
SMITH-PETERSEN osteotomo	197	tijera vascular FAVALORO	32	YASARGIL pinza para laminectomia	245
SMITH-PETERSEN pinza gubia	166	tijera vascular MILLS	29	YASARGIL pinza para tumores y tejido	70, 72
SMITH-POTTS pinza de diseccion	50	tijera vascular POTTS-DE MARTEL	29	YASARGIL tubo de aspiracion	232
SMITH-POTTS tijera vascular	30-31	tijera vascular POTTS-SMITH	30-31	YASARGIL-NICOLA pinza	271
SMITHWICK gancho	110	tijeras	20-47	YASARGIL-OKONEY horquilla para tumores	254
SMITHWICK pinza aplicadora	174	tijeras micro	35-46, 271-272	YASARGIL-POTTS micro tijera	44-45
sonda	249, 256	TOENNIS disector	221	YASARGIL-SAMII pinza para tumores y tejido	72
sonda JACOBSON	249	TOENNIS pinza para tumores	91		
sonda RHOTON	256	TOENNIS-ADSON tijera de diseccion	27	Z	
SPINAL cucharilla cortante	186-187	TOENNIS-OLIVECRONA pinza aplicadora	174	ZAUFAL-JANSEN pinza gubia	167
SPRATT cucharilla cortante	184	tornillos de distraccion	160	ZIELKE gubia	202
SPURLING pinza para laminectomia	238	TRAVERS separador	125	ZÖLLNER tubo de aspiracion	232
STAMM pinza cortante para huesos	172	trepano	181-182		
STANDARD pinza aplicadora	305	trepano craneal GALT	181		
STANDARD tijera para cirugia	20	trepano MICHELE	182		
STELLBRINK pinza gubia	162	TROEMNER martillo de percusion	8		
STEVENS tijera	28	TROUTMAN-CHRIS rompe-hojas	17		
STILLE (LEKSELL) pinza gubia	170	tubo de aspiracion	230-234		
STILLE cincel	196	tubo de aspiracion ADSON	230		
STILLE gubia	196	tubo de aspiracion BARON	231		
STILLE osteotomo	196	tubo de aspiracion FERGUSSON	230		
STILLE perforador de mano	322	tubo de aspiracion FRAZIER/FERGUSSON	231		
STILLE-GIERTZ costotomo	48	tubo de aspiracion HOUSE	233		
STILLE-HORSLEY pinza cortante para huesos	173	tubo de aspiracion PLESTER	233		
STILLE-LIJER pinza gubia	169	tubo de aspiracion SCHUHKNECHT	231		
STILLE-MAYO tijera de diseccion	22	tubo de aspiracion WULLSTEIN	234		
STILLE-RUSKIN pinza gubia	169	tubo de aspiracion YASARGIL	232		
STILLE-SHERMAN perforador de mano	323	tubo de aspiracion ZÖLLNER	232		
STRULLY GIGLI mango para sierra	177	tubo de puncion FRAZIER/FERGUSSON	231		
STRULLY tijera para neurocirugia	33	tubo de succion	230-234		
SWEET pinza aplicadora	174				
		U			
T		ultra-ligera pinza	65		
taladro	160, 176, 322-324	UNIVERSAL tijera para alambre	34		
taladro CUSHING	324	USA MOD - TAYLOR martillo de percusion	8		
taladro ERRICO	324				
taladro MC KENZIE	324	V			
tapas de repuesto para martillo	9-10	VANNAS micro tijera	37, 42, 44-45		
TAYLOR - USA MOD martillo de percusion	8	VOLKMANN cucharilla cortante	184, 192		
TAYLOR hoja	137				
TAYLOR pinza de diseccion	58				
TAYLOR separador espinal	107				
TAYLOR-CUSHING pinza de diseccion	57				
TAYLOR-SCHMIEDEN tijera para duramadre	34				

A					
AACHEN spatole cerebrali.....	274				
ACLAND approssimatore.....	315-317				
ACLAND micro clips vascolari.....	315-317				
ACLAND pinze applicatrice.....	318				
ADAMS-MAYO divaricatore.....	124				
adattator per aspirazione HOUSE.....	231				
ADLERKREUTZ pinze per dissezione.....	54				
ADSON ANDERSON divaricatore.....	128				
ADSON BABY pinze.....	88				
ADSON divaricatore.....	125-126, 129				
ADSON elevatore.....	218				
ADSON pinze guida-perforatore e proteggi dura-madre.....	181				
ADSON pinze per dissezione.....	51-52				
ADSON pinze per ipofisi.....	261				
ADSON pinze sgorbie.....	163				
ADSON tubo aspirazione.....	230				
ADSON uncino.....	110				
ADSON-BECKMANN (CONE) divaricatore.....	126, 130				
ADSON-BROWN pinze per dissezione.....	52				
ADSON-TOENNIS forcici.....	27				
ago RHOTON.....	256				
ALEXANDER periototomo.....	210				
ALEXANDER-MATSON periototomo.....	214				
algesimetro WARTENBERG.....	11				
ALM divaricatore.....	120				
ANDERSON ADSON divaricatore.....	128				
approssimatore ACLAND.....	315-317				
approssimatore BIEMER.....	312				
arco per trazione craniale CRUTCHFIELD.....	176				
AUSTIN micro pinze.....	64				
B					
BABINSKY martelli da percussione.....	8				
BABY ADSON pinze.....	88				
BABY MIXTER pinze.....	90				
BABY-METZENBAUM-BLACK forcici per dissezione.....	25				
BACON pinze sgorbie.....	166				
BADGLEY divaricatore.....	139				
BANE-HARTMANN pinze sgorbie.....	164				
BARON tubo aspirazione.....	231				
BARRAQUER micro porta aghi.....	96				
battenti di ricambio.....	9-10				
BAUMGARTNER porta aghi.....	94				
BECKMANN divaricatore.....	132				
BECKMANN-ADSON (CONE) divaricatore.....	126, 130				
BECKMANN-EATON divaricatore.....	132				
BERLINER martelli da percussione.....	8				
BEYER pinze sgorbie.....	165, 167				
BIEMER approssimatore.....	312				
BIEMER clips per vasi.....	306, 308-309, 311				
BIEMER divaricatore per vasi.....	250				
BIEMER micro forcici.....	44-45				
BIEMER pinze applicatrice.....	306, 308-309, 311				
bipolare cavi.....	335				
bipolare pinze.....	328-333				
bipolare pinze con canale di aspirazione.....	334				
bipolare pinze non-stick.....	332-333				
bisturi.....	15				
BLACK forcici per dissezione.....	25				
BLACK METZENBAUM forcici per dissezione.....	24-25				
BLAKESLEY-WEIL pinze per laminectomia.....	244				
BÖHLER cesoie per ossa.....	172				
BÖHLER pinze sgorbie.....	167				
BOIES sgorbia.....	211				
BROPHY pinze per dissezione.....	54				
BROWN pinze per dissezione.....	53				
BROWN-ADSON pinze per dissezione.....	52				
BRUNS curette.....	188				
BUCK martelli da percussione.....	8				
bulldog pinze.....	78-82				
bulldog pinze DE BAKEY.....	80-82				
bulldog pinze DIETRICH.....	78				
bulldog pinze GLOVER.....	81				
BUNELL perforatore a mano.....	325				
BUSHE curette.....	191				
C					
cacciavite.....	160				
calibro.....	11				
cannula micro d'aspirazione.....	234				
cannula per punzione FRAZIER/FERGUSSON.....	231				
canula per manico di aspirazione.....	232				
CAROLL pinze da presa per tendini.....	92				
CASPAR divaricatore.....	136, 144, 154-156, 158				
CASPAR manico per lame bisturi.....	16				
CASPAR micro dissettore.....	228				
CASPAR pinze per laminectomia.....	242-243				
CASPAR pistoni.....	195				
CASPAR sonda conduttrice a forchetta.....	253				
CASPAR sostegno osseo e impattatore.....	194				
CASPAR uncino.....	112, 115				
CASPAR-PAPAVERO specoli per ipofisectomia.....	264				
CASTROVIEJO micro forcici.....	36				
CASTROVIEJO micro porta aghi.....	97				
CASTROVIEJO rompi lama.....	17				
cavi bipolare.....	335				
cesoie per ossa.....	172-173				
cesoie per ossa BÖHLER.....	172				
cesoie per ossa COTTLE-KAZANJIAN.....	172				
cesoie per ossa LISTON.....	172				
cesoie per ossa MC INDOE.....	172				
cesoie per ossa RUSKIN-LISTON.....	172				
cesoie per ossa SEMB.....	173				
cesoie per ossa STAMM.....	172				
cesoie per ossa STILLE-HORSLEY.....	173				
cesoie per ossa STILLE-LISTON.....	173				
CHEYNE-WATSON elevatore.....	219				
chiave.....	10, 136, 312, 325, 326				
CITELLI pinze-punzoni.....	288				
clips micro vascolari BIEMER.....	312				
clips micro vascolari ACLAND.....	315-317				
clips per aneurisma YASARGIL.....	290-301				
clips per vasi.....	306-310				
clips per vasi BIEMER.....	306, 308-309, 311				
clips per vasi MEHDORN.....	307				
clips per vasi MÜLLER.....	310				
CLOWARD divaricatore.....	103, 140-143, 151, 153				
CLOWARD pinze per laminectomia.....	239				
coagulazione bipolare.....	328-333				
COBB curette.....	185				
COBB elevatore.....	217				
COBB sgorbia.....	200				
COLCLOUGH pinze taglienti per dischi intervertebrali.....	286				
COLLIN-FARABEUF periototomo.....	206-207				
coltello micro per vasi KOOS.....	248-249				
coltello micro per vasi YASARGIL.....	248				
coltello per tumore SAMIL.....	251-252				
conduttori per legature KRAYENBÜHL.....	116				
CONE curette.....	260				
CONE pinza per craniotomia.....	179				
container per conservazione e sterilizzazione.....	313-314				
CONTOUR-SCALP divaricatore.....	127				
costotomi.....	48				
costotomi GIERTZ-STILLE.....	48				
costotomi SAUERBRUCH.....	48				
costotomi SAUERBRUCH-FREY.....	48				
COTTLE martelli.....	10				
COTTLE osetotomo.....	204				
COTTLE pinze.....	74				
COTTLE-KAZANJIAN cesoie per ossa.....	172				
CRILE pinze emostatiche.....	85				
CRILE uncino.....	109				
CRILE-RANKIN pinze emostatiche.....	85				
CRILE-WOOD porta aghi.....	94				
CRUTCHFIELD arco per trazione craniale.....	176				
cucchiaio FAHLBUSCH.....	270				
cucchiaio HARDY.....	269				
cucchiaio LANDOLT.....	267				
curette.....	184-193, 256, 260, 262, 265, 267-268, 270				
curette BRUNS.....	188				
curette BUSHE.....	191				
curette COBB.....	185				
curette CONE.....	260				
curette DAUBENSPECK.....	189				
curette FAHLBUSCH.....	270				
curette HALLE.....	186				
curette JANSEN.....	192				
curette LANDOLT.....	267				
curette LANDOLT-REULEN.....	270				
curette LEMPERT.....	190				
curette micro.....	193				
curette micro YASARGIL.....	193				
curette NICOLA.....	265				
curette per ipofisi HARDY.....	268				
curette REDA.....	190-191				
curette RHOTON.....	256				
curette SCOVILLE.....	187				
curette SPINAL.....	186-187				
curette SPRATT.....	184				
curette VOLKMANN.....	184, 192				
CUSHING (LITTLE-JOKER) periototomo.....	207				
CUSHING divaricatore.....	103				
CUSHING periototomo.....	208				
CUSHING pinze per dissezione.....	53				
CUSHING pinze per laminectomia.....	238				
CUSHING spatole cerebrali.....	274				
CUSHING trapano.....	324				
CUSHING uncino.....	109				
CUSHING-LANDOLT specoli per ipofisectomia.....	263				
CUSHING-TAYLOR pinze per dissezione.....	57				
D					
DANDY forcici per trigemino.....	33				
DANDY pinze emostatiche.....	86				
DANDY uncino.....	108				
DARLING divaricatore.....	147				
DAUBENSPECK curette.....	189				
DAVIS dissettore per dura-madre.....	221-222				
DAVIS spatole cerebrali.....	275				
DE BAKEY forcici vascolari.....	30-32				
DE BAKEY micro pinze.....	67				
DE BAKEY pinze.....	68-69				
DE BAKEY pinze bulldog.....	80-82				
DE BAKEY porta aghi.....	95				
DE BAKEY-DIETRICH pinze bulldog.....	78				
DE BAKEY-HESS pinze bulldog.....	82				
DE MARTEL-POTTS forcici vascolari.....	29				
DEAVER forcici per chirurgia.....	21				
DEJERINE martelli da percussione.....	8				
delicate forcici.....	27-28				
deMARTEL strumenti introduttori.....	177				
D'ERRICO uncino.....	113				
DeVILBISS pinza per craniotomia.....	178				
diapason.....	11				
DIFFENBACH pinze serrafina.....	83				
DIETRICH pinze bulldog.....	78				
DIETRICH-DE BAKEY pinze bulldog.....	78				
DIETRICH forcici vascolari.....	29-30				
dilatatori vascolari.....	61, 250				
dissettore.....	211, 221-224, 256, 266, 270				
dissettore GORNEY.....	211				
dissettore HARDY-FAHLBUSCH.....	266				
dissettore LANDOLT-REULEN.....	270				
dissettore micro.....	227-228				
dissettore micro YASARGIL.....	227				
dissettore PENFIELD.....	224				
dissettore per dura-madre DAVIS.....	221-222				
dissettore per dura-madre FRAZIER.....	223				
dissettore per dura-madre HOEN.....	223				
dissettore per dura-madre HORSLEY.....	222				
dissettore per dura-madre MULLIGAN.....	222				
dissettore per dura-madre OLIVECROMA.....	221				
dissettore per dura-madre SACHS.....	221				
dissettore per dura-madre TOENNIS.....	221				
dissettore per dura-madre WOODSON.....	223				
dissettore RHOTON.....	256				
divaricatore.....	103-107, 120-144				
divaricatore ADSON.....	125-126, 129				
divaricatore ALM.....	120				
divaricatore ANDERSON ADSON.....	128				
divaricatore BADGLEY.....	139				
divaricatore BECKMANN.....	132				
divaricatore BECKMANN-ADSON (CONE).....	126, 130				
divaricatore BECKMANN-EATON.....	132				
divaricatore CASPAR.....	136, 144, 154-156, 158				
divaricatore CLOWARD.....	103, 140-143, 151, 153				

pinze bulldog DIETHRICH.....	78	pinze serrafina DIEFFENBACH.....	83	REULEN-LANDOLT raspatore.....	270
pinze bulldog GLOVER.....	81	pinze serrafina JOHNS-HOPKINS.....	83	REULEN-LANDOLT uncino.....	270
pinze COTTLE.....	74	pinze sgorbie.....	162-171	REYNOLDS forbici per dissezione.....	26
pinze da orologio.....	60-61	pinze sgorbie ADSON.....	163	RHOTON ago.....	256
pinze da presa per tendini CAROLL.....	92	pinze sgorbie BACON.....	166	RHOTON curette.....	256
pinze da presa YASARGIL-NICOLA.....	271	pinze sgorbie BANE-HARTMANN.....	164	RHOTON dissettore.....	256
pinze DE BAKEY.....	68-69	pinze sgorbie BEYER.....	165, 167	RHOTON periostotomo.....	256
pinze emostatiche CRILE.....	85	pinze sgorbie BÖHLER.....	167	RHOTON sonda.....	256
pinze emostatiche CRILE-RANKIN.....	85	pinze sgorbie ECHLIN.....	171	RHOTON uncino.....	256
pinze emostatiche DANDY.....	86	pinze sgorbie FRIEDMANN.....	162	RICHTER-SCOVILLE divaricatore.....	138
pinze emostatiche HALSTED-MOSQUITO.....	84	pinze sgorbie FRIEDMANN MINI.....	162	ROGER elevatore.....	220
pinze emostatiche HARTMANN.....	83	pinze sgorbie FRYKHOLM.....	171	rompi lama.....	17
pinze emostatiche KELLY.....	85	pinze sgorbie JANSEN.....	164	rompi lama CASTROVIEJO.....	17
pinze emostatiche KELLY-RANKIN.....	85	pinze sgorbie KLEINERT-KUTZ.....	165	rompi lama REDA.....	17
pinze FUCHSIG.....	88	pinze sgorbie LEKSELL (STILLE).....	170	rompi lama TROUTMAN-CHRIS.....	17
pinze GEMINI.....	89	pinze sgorbie LEMPERT.....	164-165	RUSKIN pinze sgorbie.....	168
pinze guida-perforatore e proteggi dura-madre ADSON.....	181	pinze sgorbie LUER.....	163	RUSKIN-LISTON cesioe per ossa.....	172
pinze JANSEN.....	74	pinze sgorbie MARQUARDT.....	168	RUSKIN-STILLE pinze sgorbie.....	169
pinze JANSEN-GRUENWALD.....	74	pinze sgorbie MAYFIELD.....	167	RYDER porta aghi.....	95
pinze LUCAE.....	74	pinze sgorbie MICRO FRIEDMANN.....	162		
pinze micro.....	62-64, 66-67, 75, 271-272	pinze sgorbie OLIVECRONA.....	164	S	
pinze micro AUSTIN.....	64	pinze sgorbie RUSKIN.....	168	SACHS dissettore per dura-madre.....	221
pinze micro DE BAKEY.....	67	pinze sgorbie SAUERBRUCH.....	170	SACHS uncino.....	110
pinze micro LAZAR.....	63	pinze sgorbie SEMB.....	171	SAMII coltello per tumore.....	251-252
pinze micro YASARGIL.....	75	pinze sgorbie SMITH-PETERSEN.....	166	SAMII pinze per afferrare tumori e tessuti.....	73
pinze MIXTER BABY.....	90	pinze sgorbie STELLBRINK.....	162	SAMII-YASARGIL pinze per afferrare tumori e tessuti.....	72
pinze NICOLA.....	271	pinze sgorbie STILLE-LUER.....	169	SAUERBRUCH costotomi.....	48
pinze per afferrare tessuti e tumori HUNT.....	70-71	pinze sgorbie STILLE-RUSKIN.....	169	SAUERBRUCH pinze sgorbie.....	170
pinze per afferrare tessuti e tumori.....	70-73	pinze sgorbie ZUFAL-JANSEN.....	167	SAUERBRUCH-FREY costotomi.....	48
pinze per afferrare tessuti e tumori HEIFETZ.....	72	pinze taglienti per dischi intervertebrali COLCLOUGH.....	286	SCALP-CONTOUR divaricatore.....	127
pinze per afferrare tessuti e tumori SAMII.....	73	pinze taglienti per dischi intervertebrali FERRIS-SMITH-KERRISON.....	282-285	scalpello.....	196
pinze per afferrare tessuti e tumori YASARGIL.....	70, 72	pinze TOENNIS.....	91	scalpello STILLE.....	196
pinze per afferrare tessuti e tumori YASARGIL-SAMII.....	72	pinze-punzoni CITELLI.....	288	SCHLESINGER pinze per laminectomia.....	239
pinze per afferrare tumori e tessuti.....	70-73	pinze-punzoni HAJEK-KOFLER.....	287-288	SCHMIEDEN-TAYLOR forbici per dura-madre.....	34
pinze per afferrare tumori e tessuti HEIFETZ.....	72	pinze-punzoni KERRISON.....	287	SCHUHKNECHT tubo aspirazione.....	231
pinze per afferrare tumori e tessuti HUNT.....	70-71	pinze-punzoni KERRISON.....	287	SCOVILLE curette.....	167
pinze per afferrare tumori e tessuti SAMII.....	73	pinze-punzoni KERRISON.....	65	SCOVILLE divaricatore.....	137
pinze per afferrare tumori e tessuti YASARGIL.....	70, 72	pistoni.....	195	SCOVILLE pinza a spatola.....	59
pinze per applicare McKENZIE.....	174	pistoni CASPAR.....	195	SCOVILLE uncino.....	111, 114, 137
pinze per applicare OLIVECRONA-TOENNIS.....	174	PLESTER divaricatore.....	122, 124	SCOVILLE valve.....	137
pinze per applicare SMITHWICK.....	174	PLESTER tubo aspirazione.....	233	SCOVILLE-HAVERFIELD divaricatore.....	137
pinze per applicare SWEET.....	174	porta aghi.....	94-100	SCOVILLE-RICHTER divaricatore.....	138
pinze per cambiare valve.....	144, 156	porta aghi BAUMGARTNER.....	94	SEBILAU elevatori.....	208
pinze per cuoio capelluto MARTEL.....	87	porta aghi CRILE-WOOD.....	94	SEDLLOT periostotomo.....	207
pinze per cuoio capelluto WILLET MARTEL.....	87	porta aghi DE BAKEY.....	95	SEDLLOT periostotomo.....	208
pinze per dissezione ADLERKREUTZ.....	54	porta aghi HALSEY.....	94	sega OLIVECRONA.....	177
pinze per dissezione ADSON.....	51-52	porta aghi MAYO-HEGAR.....	95	SELDIN periostotomo.....	211
pinze per dissezione ADSON-BROWN.....	52	porta aghi micro.....	96-100	SEMB cesioe per ossa.....	173
pinze per dissezione BROPHY.....	54	porta aghi micro BARRAQUER.....	96	SEMB pinze sgorbie.....	171
pinze per dissezione BROWN.....	53	porta aghi micro CASTROVIEJO.....	97	SEMKEN pinze per dissezione.....	56
pinze per dissezione CUSHING.....	53	porta aghi micro YASARGIL.....	98	separatoro INGE.....	152
pinze per dissezione CUSHING-TAYLOR.....	57	porta aghi NEIVERT.....	94	serrafina pinze DIEFFENBACH.....	83
pinze per dissezione DUEHRSEN.....	55	porta aghi RYDER.....	95	set.....	338-343
pinze per dissezione GERALD.....	56-57	porta-fermagli.....	174	SEWALL elevatore.....	219
pinze per dissezione GILLIES.....	56	posa clips MINI.....	302-305	sgorbia.....	196-197, 200-203, 211
pinze per dissezione MAYO.....	58	posa clips STANDARD.....	302-305	sgorbia BOIES.....	211
pinze per dissezione McINDOE.....	55	POTTS-DE MARTEL forbici vascolari.....	29	sgorbia COBB.....	200
pinze per dissezione POTTS-SMITH.....	50	POTTS-SMITH forbici vascolari.....	30-31	sgorbia LEXER.....	201
pinze per dissezione SEMKEN.....	56	POTTS-SMITH pinze per dissezione.....	50	sgorbia LEXER MINI.....	201
pinze per dissezione TAYLOR.....	58	POTTS-YASARGIL micro forbici.....	44-45	sgorbia SMITH-PETERSEN.....	197
pinze per dissezione WANGENSTEEN.....	58			sgorbia STILLE.....	196
pinze per dissezione WAUGH.....	53	Q		sgorbia ZIELKE.....	202
pinze per gioielliere.....	61	QUERVAIN elevatori.....	208	SHERMANN-STILLE perforatore a mano.....	323
pinze per ipofisi ADSON.....	261			sistema di distrazione vertebrale cervicale.....	159
pinze per laminectomia.....	238-244	R		sistema di fissaggio LEYLA.....	276-280
pinze per laminectomia CASPAR.....	242-243	RALK perforatore a mano.....	326	SMITH-FERRIS pinze per laminectomia.....	241
pinze per laminectomia CLOWARD.....	239	RANEY femaglio.....	176	SMITH-PETERSEN osteotomo.....	197
pinze per laminectomia CUSHING.....	238	RANEY pinze applicatrice.....	176	SMITH-PETERSEN pinze sgorbie.....	166
pinze per laminectomia FERRIS-SMITH.....	241	RANKIN-CRILE pinze emostatiche.....	85	SMITH-PETERSEN sgorbia.....	197
pinze per laminectomia HOEN.....	240	RANKIN-KELLY pinze emostatiche.....	85	SMITH-POTTS pinze per dissezione.....	50
pinze per laminectomia LOVE-GRUENWALD.....	238	raspatore LANDOLT-REULEN.....	270	SMITHWICK pinze per applicare.....	174
pinze per laminectomia OLDBERG.....	245	raspatore NICOLA.....	265	SMITHWICK uncino.....	110
pinze per laminectomia SCHLESINGER.....	239	raspatore con aspiratore GUILLEN.....	235	sonda conduttrice a forchetta CASPAR.....	253
pinze per laminectomia SPURLING.....	238	REDATA curette.....	190-191	sonda conduttrice a forchetta JACOBSON.....	253
pinze per laminectomia WAGNER.....	241	REDA manico per sega.....	177	sonda JACOBSON.....	249
pinze per laminectomia WEIL-BLAKESLEY.....	244	REDA perforatore a mano.....	326	sonda RHOTON.....	256
pinze per laminectomia YASARGIL.....	245	REDA rompi lama.....	17	ostegno osseo e impattatore CASPAR.....	194
pinze per specoli LANDOLT.....	263	regolo.....	11	spatola HOSOBUCHI.....	267
pinze per specoli PAPAVERO-HARTMANN.....	264	REULEN-LANDOLT curette.....	270	spatole cerebrali AACHEN.....	274
pinze proteggi dura-madre e guida-perforatore ADSON.....	181	REULEN-LANDOLT dissettore.....	270	spatole cerebrali CUSHING.....	274

spatole cerebrali DAVIS	275	uncino LOVE	113-114
spatole cerebrali HEIFETZ	275	uncino per dura madre FISCH	249
spatole cerebrali OLIVECRONA	274	uncino per pelle FRAZIER	102
specchio micro HARDY	269	uncino per pelle FREER	102
specoli per ipofisectomia CUSHING-LANDOLT	263	uncino per pelle GILLIES	102
specoli per ipofisectomia PAPAVERO-CASPAR	264	uncino per pelle JOSEPH	102
SPINAL curette	186-187	uncino per tessuto	255
SPRATT curette	184	uncino RHOTON	256
SPURLING pinze per laminectomia	238	uncino SACHS	110
STAMM cesoie per ossa	172	uncino SCOVILLE	111, 114, 137
STANDARD forbici per chirurgia	20	uncino SMITHWICK	110
STANDARD posa clips	302-305	UNIVERSAL forbici per filo di metallo e lamiera	34
STELLBRINK pinze sgorbie	162	USA Mod. - TAYLOR martelli da percussione	8
STEVENS forbici	28		
STILLE (LEKSELL) pinze sgorbie	170	V	
STILLE osteotomo	196	valve	136-138, 140-146, 154-157
STILLE perforatore a mano	322	valve SCOVILLE	137
STILLE scalpello	196	valve TAYLOR	137
STILLE sgorbia	196	VANNAS micro forbici	36, 42, 44-45
STILLE-GIERTZ costotomi	48	vite distrattore	160
STILLE-HORSLEY cesoie per ossa	173	VOLKMANN curette	184, 192
STILLE-LISTON cesoie per ossa	173		
STILLE-LUER pinze sgorbie	169	W	
STILLE-MAYO forbici per dissezione	22	WAGNER martelli	10
STILLE-RUSKIN pinze sgorbie	169	WAGNER periostotomo	217
STILLE-SHERMANN perforatore a mano	323	WAGNER pinze per laminectomia	241
STRULLY forbici per neurochirurgia	33	WALTON divaricatore	135
STRULLY GIGLI manico per sega	177	WANGENSTEEN pinze per dissezione	58
strumenti introduttori DeMARTEL	177	WARTENBERG algesimetro	11
SWEET pinze per applicare	174	WATSON-CHEYNE elevatore	219
		WAUGH pinze per dissezione	53
T		WEIL-BLAKESLEY pinze per laminectomia	244
TAYLOR - USA Mod. martelli da percussione	8	WEITLANER divaricatore	121
TAYLOR divaricatore	107	WEITLANER-WULLSTEIN divaricatore	121
TAYLOR pinze per dissezione	58	WERBER JAMESON forbici per dissezione	26
TAYLOR valve	137	WILLET MARTEL pinze per cuoio capelluto	87
TAYLOR-CUSHING pinze per dissezione	57	WILLIAMS divaricatore	149
TAYLOR-SCHMIEDEN forbici per dura-madre	34	WILLIGER martelli	9
TOENNIS dissettore per dura-madre	221	WILLIGER periostotomo	210
TOENNIS pinze	91	WOOD-CRILE porta aghi	94
TOENNIS-ADSON forbici	27	WOODSON dissettore per dura-madre	223
TOENNIS-OLIVECRONA pinze per applicare	174	WULLSTEIN divaricatore	122
trapano	322-324	WULLSTEIN tubo aspirazione	234
trapano CUSHING	324	WULLSTEIN-WEITLANER divaricatore	121
trapano ERRICO	324		
trapano GALT	181	Y	
trapano MC KENZIE	324	YASARGIL clips per aneurisma	290-301
trapano MICHELE	182	YASARGIL forchetta per tumore	257
TRAVERS divaricatore	125	YASARGIL micro coltello per vasi	248
TROEMNER martelli da percussione	8	YASARGIL micro curette	193
TROUTMAN-CHRIS rompi lama	17	YASARGIL micro dissettore	227
tubo aspirazione	230-234	YASARGIL micro forbici	41-42, 44
tubo aspirazione ADSON	230	YASARGIL micro periostotomo	225-226
tubo aspirazione BARON	231	YASARGIL micro pinze	75
tubo aspirazione FERGUSSON	230	YASARGIL micro porta aghi	98
tubo aspirazione HOUSE	233	YASARGIL pinze per afferrare tumori e tessuti	70, 72
tubo aspirazione PLESTER	233	YASARGIL pinze per laminectomia	245
tubo aspirazione SCHUHKNECHT	231	YASARGIL tubo aspirazione	232
tubo aspirazione WULLSTEIN	234	YASARGIL-NICOLA pinza da presa	271
tubo aspirazione YASARGIL	232	YASARGIL-OKONEK forchetta per tumore	254
tubo aspirazione ZÖLLNER	232	YASARGIL-POTTS micro forbici	44-45
tubo aspirazione FRAZIER/FERGUSSON	231	YASARGIL-SAMII pinze per afferrare tumori e tessuti	72
U		Z	
ultra-leggera-pinze	65	ZAUFAL-JANSEN pinze sgorbie	167
uncinetti micro FISCH	118	ZIELKE sgorbia	202
uncinetti micro JACOBSON	118	ZÖLLNER tubo aspirazione	232
uncino	102, 108-118, 136, 249, 256, 270		
uncino ADSON	110		
uncino CASPAR	112, 115		
uncino CRILE	109		
uncino CUSHING	109		
uncino DANDY	108		
uncino D'ERRICO	113		
uncino FISCH	249		
uncino GRAHAM	110		
uncino HESS	111		
uncino HOLDSHER	111		
uncino LANDOLT	267		
uncino LANDOLT-REULEN	270		

Weitere Kataloge und Prospekte
Other cataloges and prospects

Hauptkatalog Chirurgische Instrumente
General catalog surgical instruments

Arthroskopie
Arthroscopy

Container Steriltechnik
Container Sterilization Technique

Endoskopie
Endoscopy

HERCULES® Drahtkneifzange
HERCULES® Wire Cutters

Plastische Chirurgie
Plastic surgery

Orthopädie
Orthopedic

Titan Instrumente
Titanium Instruments



INSTRUMENTE GMBH

Gänsäcker 34
P.O. Box 131
D-78532 Tuttlingen
Germany



Fon +49 7462.9445-0
Fax +49 7462.9445-20
info@Reda-Instrumente.de
www.Reda-Instrumente.de